

TPS22918 5.5-V, 2-A, 52-mΩ On-Resistance Load Switch

1 Features

- Integrated Single Channel Load Switch
- Ambient Operating Temperature: -40°C to $+105^{\circ}\text{C}$
- Input Voltage Range: 1 V to 5.5 V
- On-Resistance (R_{ON})
 - $R_{\text{ON}} = 52\text{ m}\Omega$ (typical) at $V_{\text{IN}} = 5\text{ V}$
 - $R_{\text{ON}} = 53\text{ m}\Omega$ (typical) at $V_{\text{IN}} = 3.3\text{ V}$
- 2-A Maximum Continuous Switch Current
- Low Quiescent Current
 - $8.3\text{ }\mu\text{A}$ (typical) at $V_{\text{IN}} = 3.3\text{ V}$
- Low-Control Input-Threshold Enables Use of 1 V or Higher GPIO
- Adjustable Quick-Output Discharge (QOD)
- Configurable Rise Time With CT Pin
- Small SOT23-6 Package (DBV)
 - 2.90-mm \times 2.80-mm, 0.95-mm Pitch, 1.45 mm Height (with leads)
- ESD Performance Tested per JESD 22
 - $\pm 2\text{-kV}$ HBM and $\pm 1\text{-kV}$ CDM

2 Applications

- Industrial Systems
- Set Top Box
- Blood Glucose Meters
- Electronic Point of Sale

3 Description

The TPS22918 is a single-channel load switch with configurable rise time and configurable quick output discharge. The device contains an N-channel MOSFET that can operate over an input voltage range of 1 V to 5.5 V and can support a maximum continuous current of 2 A. The switch is controlled by an on and off input, which is capable of interfacing directly with low-voltage control signals.

The configurable rise time of the device greatly reduces inrush current caused by large bulk load capacitances, thereby reducing or eliminating power supply droop. The TPS22918 features a configurable quick output discharge (QOD) pin, which controls the fall time of the device to allow design flexibility for power down and sequencing.

The TPS22918 is available in a small, leaded SOT-23 package (DBV) which allows visual inspection of solder joints. The device is characterized for operation over the free-air temperature range of -40°C to $+105^{\circ}\text{C}$.

Device Information (1)

PART NUMBER	PACKAGE	BODY SIZE (NOM)
TPS22918	SOT-23 (6)	2.90 mm \times 1.60 mm

(1) For all available packages, see the orderable addendum at the end of the datasheet.

Simplified Schematic

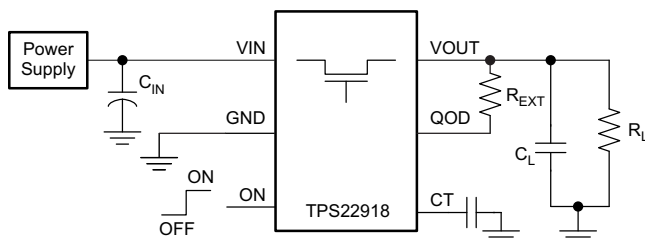

On-Resistance vs Input Voltage Typical Values

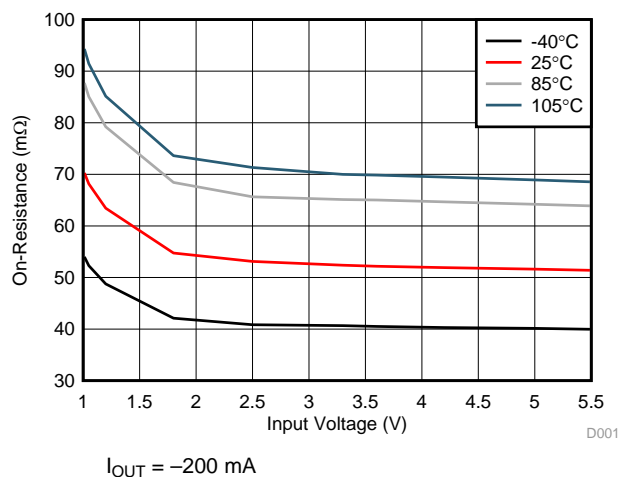

Table of Contents

1 Features 1 2 Applications 1 3 Description 1 4 Revision History 2 5 Pin Configuration and Functions 3 6 Specifications 4 6.1 Absolute Maximum Ratings 4 6.2 ESD Ratings 4 6.3 Recommended Operating Conditions 4 6.4 Thermal Information 4 6.5 Electrical Characteristics 5 6.6 Switching Characteristics 6 6.7 Typical DC Characteristics 7 6.8 Typical AC Characteristics 9 7 Parameter Measurement Information 11 8 Detailed Description 12 8.1 Overview 12 8.2 Functional Block Diagram 12	8.3 Feature Description 13 8.4 Device Functional Modes 15 9 Application and Implementation 16 9.1 Application Information 16 9.2 Typical Application 16 10 Power Supply Recommendations 20 11 Layout 20 11.1 Layout Guidelines 20 11.2 Layout Example 21 11.3 Thermal Considerations 21 12 Device and Documentation Support 22 12.1 Device Support 22 12.2 Documentation Support 22 12.3 Community Resources 22 12.4 Trademarks 22 12.5 Electrostatic Discharge Caution 22 12.6 Glossary 22 13 Mechanical, Packaging, and Orderable Information 22
------------------------------------------------------------------------------------------------------------------------------------------------------------------------------------------------------------------------------------------------------------------------------------------------------------------------------------------------------------------------------------------------------------------------------------------------------------------------------------------------------------------------------------------------------------------------------------------------------------------------------------------------------------------------------------------------------------------------	------------------------------------------------------------------------------------------------------------------------------------------------------------------------------------------------------------------------------------------------------------------------------------------------------------------------------------------------------------------------------------------------------------------------------------------------------------------------------------------------------------------------------------------------------------------------------------------------------------------------------------------------------------------------------------------------------------------------------------------------------

4 Revision History

NOTE: Page numbers for previous revisions may differ from page numbers in the current version.

Changes from Revision A (March 2016) to Revision B	Page
<ul style="list-style-type: none"> • Updated the constant value in Equation 3 in <i>Adjustable Rise Time (CT)</i> section 14 	14
Changes from Revision B (June 2016) to Revision C	Page
<ul style="list-style-type: none"> • Updated the <i>Applications Section</i> changed μF to pF in Figure 30, Figure 31, and Section 9.2.2.5 1 	1
Changes from Original (February 2016) to Revision A	Page
<ul style="list-style-type: none"> • Changed device status from <i>Product Preview</i> to <i>Production Data</i> 1 	1

5 Pin Configuration and Functions

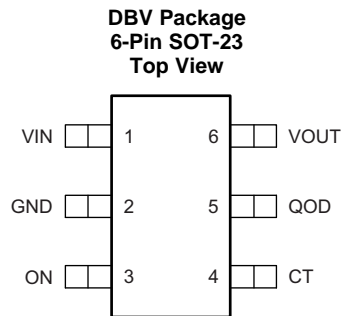

Pin Functions

PIN		I/O	DESCRIPTION
NO.	NAME		
1	VIN	I	Switch input. Place ceramic bypass capacitor(s) between this pin and GND. See the Detailed Description section for more information.
2	GND	—	Device ground.
3	ON	I	Active high switch control input. Do not leave floating.
4	CT	O	Switch slew rate control. Can be left floating. See the Feature Description section for more information.
5	QOD	O	Quick Output Discharge pin. This functionality can be enabled in one of three ways. <ul style="list-style-type: none"> Placing an external resistor between VOUT and QOD Tying QOD directly to VOUT and using the internal resistor value (R_{PD}) Disabling QOD by leaving pin floating See the Quick Output Discharge (QOD) section for more information.
6	VOUT	O	Switch output.

6 Specifications

6.1 Absolute Maximum Ratings

Over operating free-air temperature range (unless otherwise noted) ⁽¹⁾ ⁽²⁾

		MIN	MAX	UNIT
V _{IN}	Input voltage	-0.3	6	V
V _{OUT}	Output voltage	-0.3	6	V
V _{ON}	ON voltage	-0.3	6	V
I _{MAX}	Maximum continuous switch current, ambient temperature = 70°C		2	A
I _{PLS}	Maximum pulsed switch current, pulse < 300 μs, 2% duty cycle		2.5	A
T _J	Maximum junction temperature		125	°C
T _{stg}	Storage temperature	-65	150	°C

- (1) Stresses beyond those listed under *Absolute Maximum Ratings* may cause permanent damage to the device. These are stress ratings only, which do not imply functional operation of the device at these or any other conditions beyond those indicated under *Recommended Operating Conditions*. Exposure to absolute-maximum-rated conditions for extended periods may affect device reliability.
- (2) All voltage values are with respect to network ground terminal.

6.2 ESD Ratings

		VALUE	UNIT
V _(ESD)	Electrostatic discharge	Human-body model (HBM), per ANSI/ESDA/JEDEC JS-001 ⁽¹⁾	±2000
		Charged-device model (CDM), per JEDEC specification JESD22-C101 ⁽²⁾	±1000

- (1) JEDEC document JEP155 states that 500-V HBM allows safe manufacturing with a standard ESD control process.
- (2) JEDEC document JEP157 states that 250-V CDM allows safe manufacturing with a standard ESD control process.

6.3 Recommended Operating Conditions

Over operating free-air temperature range (unless otherwise noted)

			MIN	MAX	UNIT
V _{IN}	Input voltage		0	5.5	V
V _{ON}	ON voltage		0	5.5	V
V _{OUT}	Output voltage			V _{IN}	V
V _{IH, ON}	High-level input voltage, ON	V _{IN} = 1 V to 5.5 V	1	5.5	V
V _{IL, ON}	Low-level input voltage, ON	V _{IN} = 1 V to 5.5 V	0	0.5	V
T _A	Operating free-air temperature ⁽¹⁾		-40	105	°C
C _{IN}	Input Capacitor		1 ⁽²⁾		μF

- (1) In applications where high power dissipation and/or poor package thermal resistance is present, the maximum ambient temperature may have to be derated. Maximum ambient temperature [T_{A(MAX)}] is dependent on the maximum operating junction temperature [T_{J(MAX)}], the maximum power dissipation of the device in the application [P_{D(MAX)}], and the junction-to-ambient thermal resistance of the part/package in the application (θ_{JA}), as given by the following equation: T_{A(MAX)} = T_{J(MAX)} - (θ_{JA} × P_{D(MAX)}).
- (2) Refer to [Application and Implementation](#) section

6.4 Thermal Information

THERMAL METRIC ⁽¹⁾		TPS22918	UNIT
		DBV (SOT-23)	
		6 PINS	
R _{θJA}	Junction-to-ambient thermal resistance	183.2	°C/W
R _{θJC(top)}	Junction-to-case (top) thermal resistance	151.6	°C/W
R _{θJB}	Junction-to-board thermal resistance	34.1	°C/W
ψ _{JT}	Junction-to-top characterization parameter	37.2	°C/W
ψ _{JB}	Junction-to-board characterization parameter	33.6	°C/W

- (1) For more information about traditional and new thermal metrics, see the [Semiconductor and IC Package Thermal Metrics](#) application report.

6.5 Electrical Characteristics

Unless otherwise noted, the specification in the following table applies over the full ambient operating temperature $-40^{\circ}\text{C} \leq T_A \leq +105^{\circ}\text{C}$. Typical values are for $T_A = 25^{\circ}\text{C}$.

PARAMETER	TEST CONDITIONS	T_A	MIN	TYP	MAX	UNIT		
$I_{Q, VIN}$ Quiescent current	$V_{ON} = 5\text{ V}, I_{OUT} = 0\text{ A}$	-40°C to $+105^{\circ}\text{C}$			$V_{IN} = 5.5\text{ V}$	9.2	16	μA
					$V_{IN} = 5\text{ V}$	8.7	16	
					$V_{IN} = 3.3\text{ V}$	8.3	15	
					$V_{IN} = 1.8\text{ V}$	10.2	17	
					$V_{IN} = 1.2\text{ V}$	9.3	16	
					$V_{IN} = 1\text{ V}$	8.9	15	
$I_{SD, VIN}$ Shutdown current	$V_{ON} = 0\text{ V}, V_{OUT} = 0\text{ V}$	-40°C to $+105^{\circ}\text{C}$			$V_{IN} = 5.5\text{ V}$	0.5	5	μA
					$V_{IN} = 5\text{ V}$	0.5	4.5	
					$V_{IN} = 3.3\text{ V}$	0.5	3.5	
					$V_{IN} = 1.8\text{ V}$	0.5	2.5	
					$V_{IN} = 1.2\text{ V}$	0.4	2	
					$V_{IN} = 1\text{ V}$	0.4	2	
I_{ON} ON pin input leakage current	$V_{IN} = 5.5\text{ V}, I_{OUT} = 0\text{ A}$	-40°C to $+105^{\circ}\text{C}$			0.1	μA		
R_{ON} On-Resistance	$V_{IN} = 5.5\text{ V}, I_{OUT} = -200\text{ mA}$	25°C		51	59	$\text{m}\Omega$		
		-40°C to $+85^{\circ}\text{C}$			71			
		-40°C to $+105^{\circ}\text{C}$			78			
	$V_{IN} = 5.0\text{ V}, I_{OUT} = -200\text{ mA}$	25°C		52	59	$\text{m}\Omega$		
		-40°C to $+85^{\circ}\text{C}$			71			
		-40°C to $+105^{\circ}\text{C}$			79			
	$V_{IN} = 4.2\text{ V}, I_{OUT} = -200\text{ mA}$	25°C		52	59	$\text{m}\Omega$		
		-40°C to $+85^{\circ}\text{C}$			71			
		-40°C to $+105^{\circ}\text{C}$			79			
	$V_{IN} = 3.3\text{ V}, I_{OUT} = -200\text{ mA}$	25°C		53	59	$\text{m}\Omega$		
		-40°C to $+85^{\circ}\text{C}$			71			
		-40°C to $+105^{\circ}\text{C}$			80			
	$V_{IN} = 2.5\text{ V}, I_{OUT} = -200\text{ mA}$	25°C		53	61	$\text{m}\Omega$		
		-40°C to $+85^{\circ}\text{C}$			75			
		-40°C to $+105^{\circ}\text{C}$			80			
	$V_{IN} = 1.8\text{ V}, I_{OUT} = -200\text{ mA}$	25°C		55	65	$\text{m}\Omega$		
		-40°C to $+85^{\circ}\text{C}$			79			
		-40°C to $+105^{\circ}\text{C}$			88			
	$V_{IN} = 1.2\text{ V}, I_{OUT} = -200\text{ mA}$	25°C		64	77	$\text{m}\Omega$		
		-40°C to $+85^{\circ}\text{C}$			88			
		-40°C to $+105^{\circ}\text{C}$			104			
	$V_{IN} = 1.0\text{ V}, I_{OUT} = -200\text{ mA}$	25°C		71	85	$\text{m}\Omega$		
		-40°C to $+85^{\circ}\text{C}$			100			
		-40°C to $+105^{\circ}\text{C}$			116			
V_{HYS} ON pin hysteresis	$V_{IN} = 1\text{ V}$ to 5.5 V	-40°C to $+105^{\circ}\text{C}$		107		mV		
R_{PD} Output pull down resistance ⁽¹⁾	$V_{IN} = 5.0\text{ V}, V_{ON} = 0\text{ V}$	25°C		24		Ω		
		-40°C to $+105^{\circ}\text{C}$			30			
	$V_{IN} = 3.3\text{ V}, V_{ON} = 0\text{ V}$	25°C		25				
		-40°C to $+105^{\circ}\text{C}$			35			
	$V_{IN} = 1.8\text{ V}, V_{ON} = 0\text{ V}$	25°C		45				
		-40°C to $+105^{\circ}\text{C}$			60			

(1) Output pull down resistance varies with input voltage. Please see [Figure 7](#) for more information.

6.6 Switching Characteristics

Refer to the timing test circuit in [Figure 21](#) (unless otherwise noted) for references to external components used for the test condition in the switching characteristics table. Switching characteristics shown below are only valid for the power-up sequence where V_{IN} is already in steady state condition before the ON pin is asserted high. $V_{ON} = 5\text{ V}$, $T_A = 25\text{ }^\circ\text{C}$, QOD = Open.

PARAMETER		TEST CONDITIONS	MIN	TYP	MAX	UNIT
$V_{IN} = 5\text{ V}$						
t_{ON}	Turn-on time	$R_L = 10\ \Omega$, $C_{IN} = 1\ \mu\text{F}$, $C_L = 0.1\ \mu\text{F}$, $CT = 1000\ \text{pF}$		1950		μs
t_{OFF}	Turn-off time	$R_L = 10\ \Omega$, $C_{IN} = 1\ \mu\text{F}$, $C_L = 0.1\ \mu\text{F}$, $CT = 1000\ \text{pF}$		2		
t_R	V_{OUT} rise time	$R_L = 10\ \Omega$, $C_{IN} = 1\ \mu\text{F}$, $C_L = 0.1\ \mu\text{F}$, $CT = 1000\ \text{pF}$		2540		
t_F	V_{OUT} fall time	$R_L = 10\ \Omega$, $C_{IN} = 1\ \mu\text{F}$, $C_L = 0.1\ \mu\text{F}$, $CT = 1000\ \text{pF}$		2		
t_D	Delay time	$R_L = 10\ \Omega$, $C_{IN} = 1\ \mu\text{F}$, $C_L = 0.1\ \mu\text{F}$, $CT = 1000\ \text{pF}$		690		
$V_{IN} = 3.3\text{ V}$						
t_{ON}	Turn-on time	$R_L = 10\ \Omega$, $C_{IN} = 1\ \mu\text{F}$, $C_L = 0.1\ \mu\text{F}$, $CT = 1000\ \text{pF}$		1430		μs
t_{OFF}	Turn-off time	$R_L = 10\ \Omega$, $C_{IN} = 1\ \mu\text{F}$, $C_L = 0.1\ \mu\text{F}$, $CT = 1000\ \text{pF}$		2		
t_R	V_{OUT} rise time	$R_L = 10\ \Omega$, $C_{IN} = 1\ \mu\text{F}$, $C_L = 0.1\ \mu\text{F}$, $CT = 1000\ \text{pF}$		1680		
t_F	V_{OUT} fall time	$R_L = 10\ \Omega$, $C_{IN} = 1\ \mu\text{F}$, $C_L = 0.1\ \mu\text{F}$, $CT = 1000\ \text{pF}$		2		
t_D	Delay time	$R_L = 10\ \Omega$, $C_{IN} = 1\ \mu\text{F}$, $C_L = 0.1\ \mu\text{F}$, $CT = 1000\ \text{pF}$		590		
$V_{IN} = 1.8\text{ V}$						
t_{ON}	Turn-on time	$R_L = 10\ \Omega$, $C_{IN} = 1\ \mu\text{F}$, $C_L = 0.1\ \mu\text{F}$, $CT = 1000\ \text{pF}$		965		μs
t_{OFF}	Turn-off time	$R_L = 10\ \Omega$, $C_{IN} = 1\ \mu\text{F}$, $C_L = 0.1\ \mu\text{F}$, $CT = 1000\ \text{pF}$		2		
t_R	V_{OUT} rise time	$R_L = 10\ \Omega$, $C_{IN} = 1\ \mu\text{F}$, $C_L = 0.1\ \mu\text{F}$, $CT = 1000\ \text{pF}$		960		
t_F	V_{OUT} fall time	$R_L = 10\ \Omega$, $C_{IN} = 1\ \mu\text{F}$, $C_L = 0.1\ \mu\text{F}$, $CT = 1000\ \text{pF}$		2		
t_D	Delay time	$R_L = 10\ \Omega$, $C_{IN} = 1\ \mu\text{F}$, $C_L = 0.1\ \mu\text{F}$, $CT = 1000\ \text{pF}$		480		
$V_{IN} = 1\text{ V}$						
t_{ON}	Turn-on time	$R_L = 10\ \Omega$, $C_{IN} = 1\ \mu\text{F}$, $C_L = 0.1\ \mu\text{F}$, $CT = 1000\ \text{pF}$		725		μs
t_{OFF}	Turn-off time	$R_L = 10\ \Omega$, $C_{IN} = 1\ \mu\text{F}$, $C_L = 0.1\ \mu\text{F}$, $CT = 1000\ \text{pF}$		3		
t_R	V_{OUT} rise time	$R_L = 10\ \Omega$, $C_{IN} = 1\ \mu\text{F}$, $C_L = 0.1\ \mu\text{F}$, $CT = 1000\ \text{pF}$		560		
t_F	V_{OUT} fall time	$R_L = 10\ \Omega$, $C_{IN} = 1\ \mu\text{F}$, $C_L = 0.1\ \mu\text{F}$, $CT = 1000\ \text{pF}$		2		
t_D	Delay time	$R_L = 10\ \Omega$, $C_{IN} = 1\ \mu\text{F}$, $C_L = 0.1\ \mu\text{F}$, $CT = 1000\ \text{pF}$		430		

6.7 Typical DC Characteristics

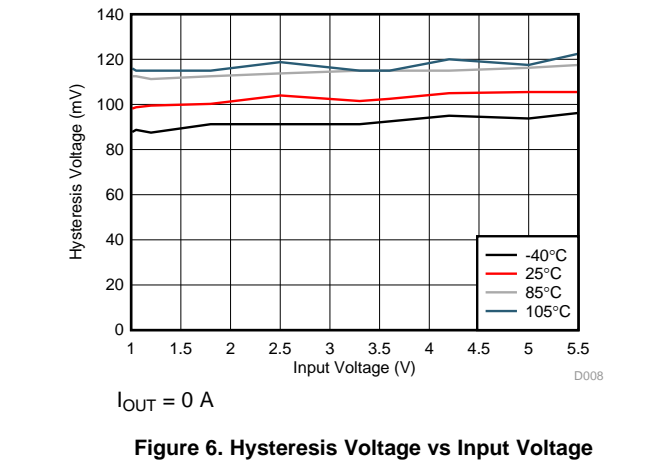
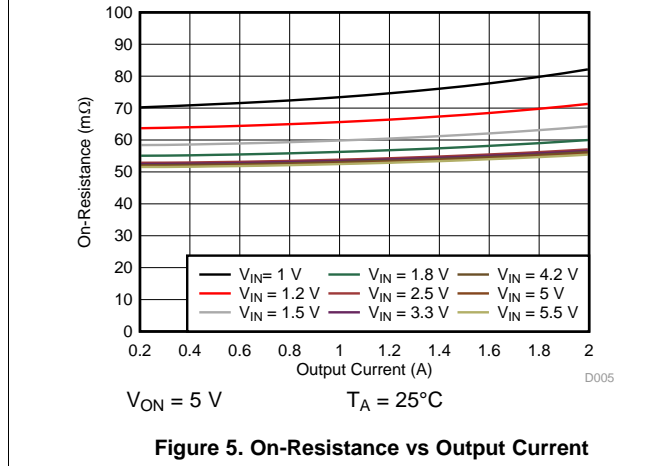
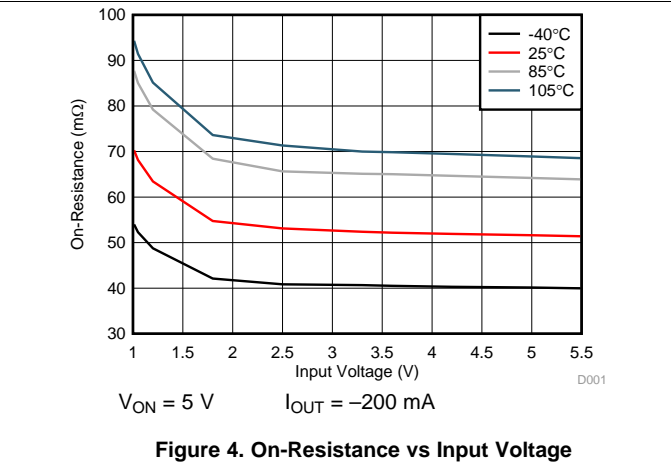
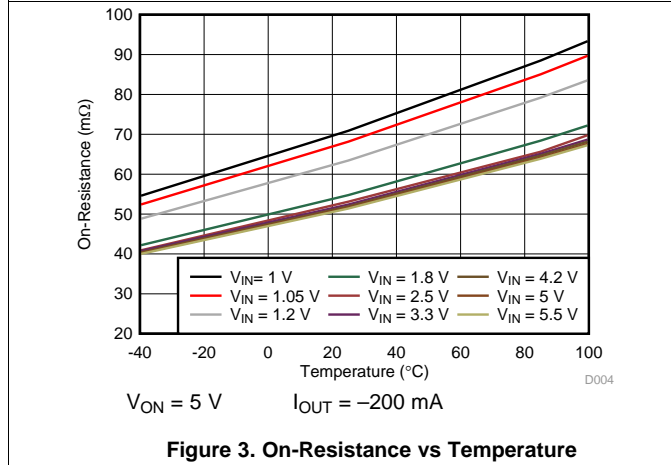
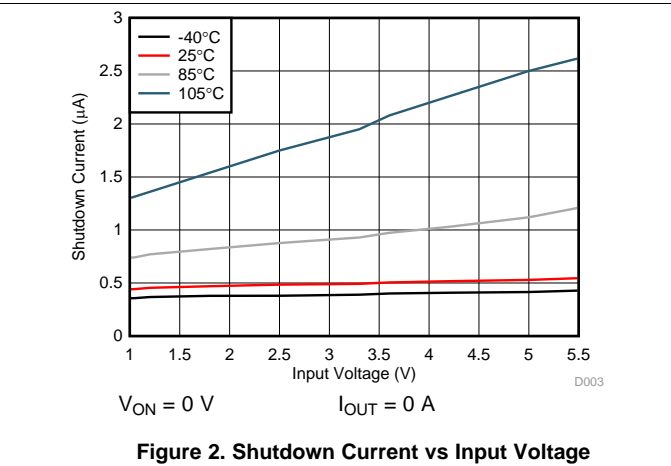
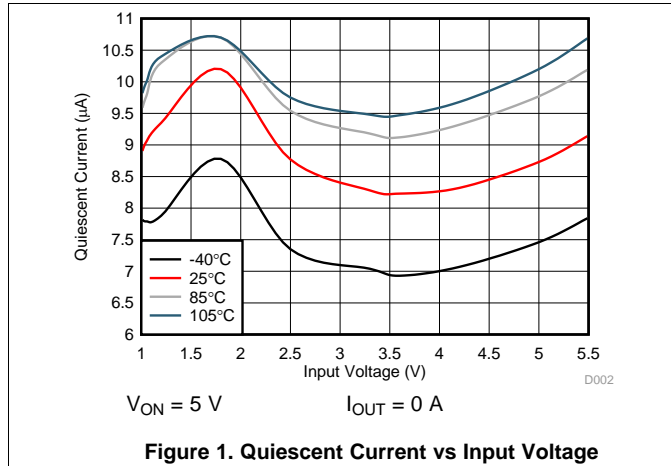

Typical DC Characteristics (continued)

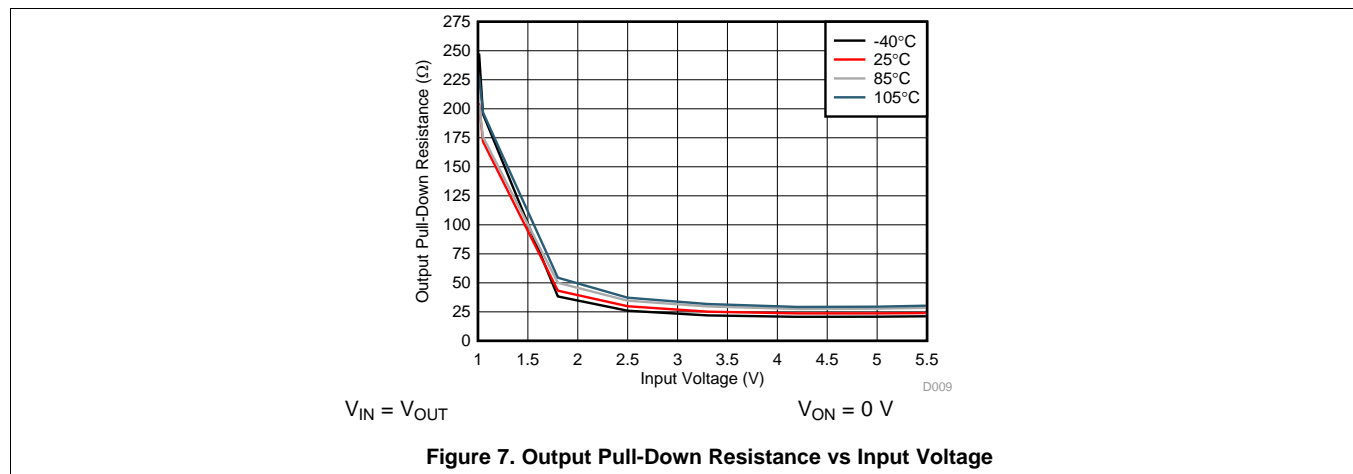

6.8 Typical AC Characteristics

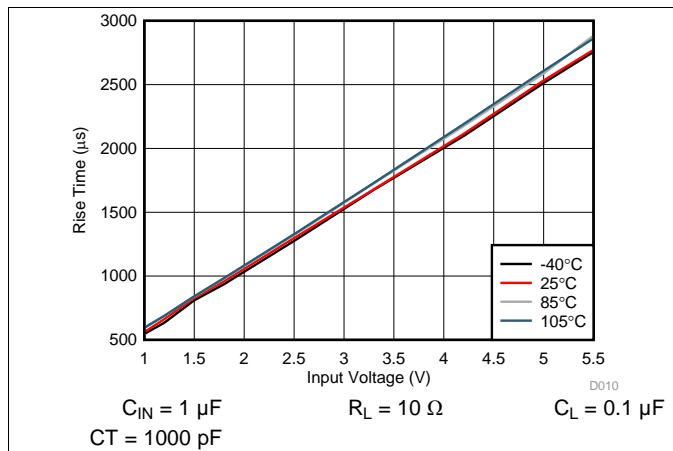

Figure 8. Rise Time vs Input Voltage

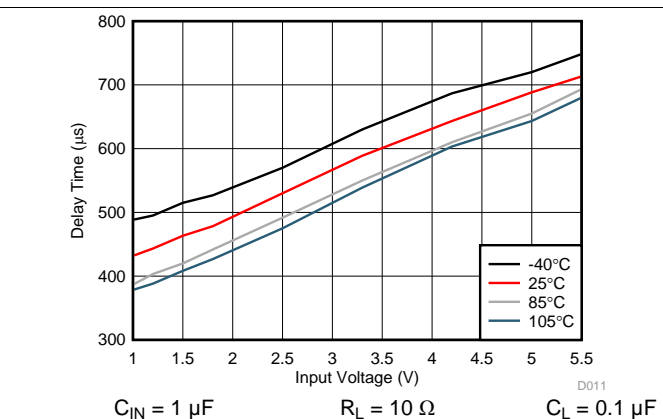

Figure 9. Delay Time vs Input Voltage

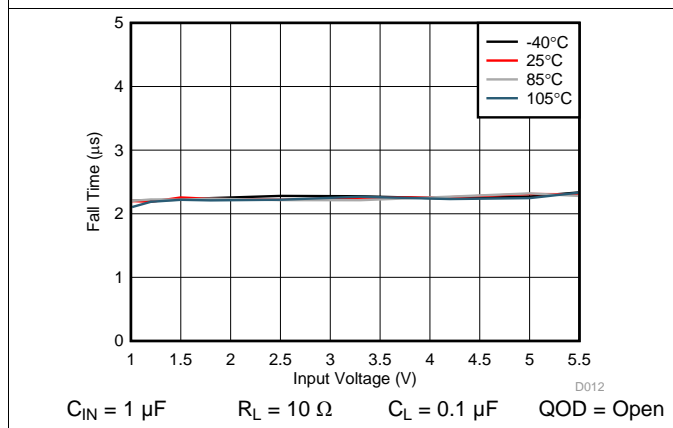

Figure 10. Fall Time vs Input Voltage

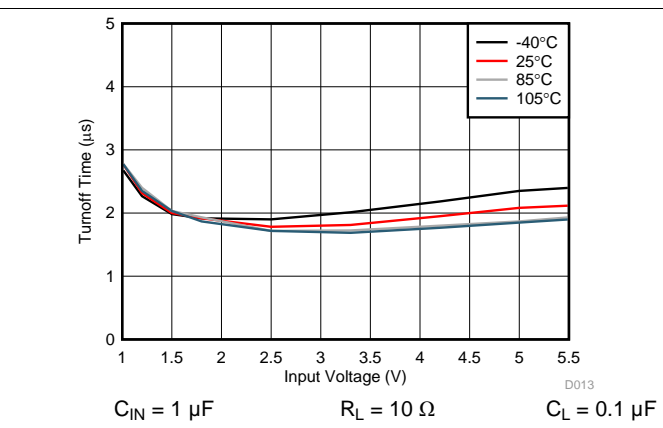

Figure 11. Turnoff Time vs Input Voltage

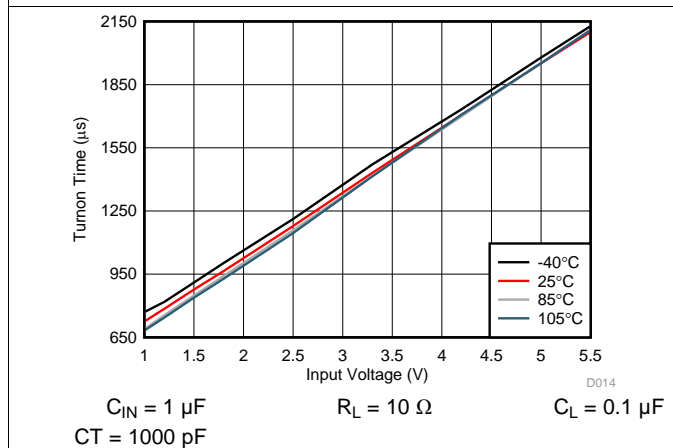

Figure 12. Turnon Time vs Input Voltage

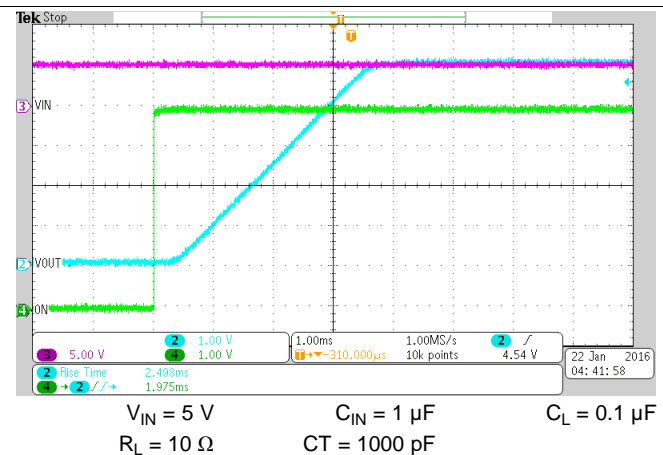

Figure 13. Rise Time (t_R) at $V_{IN} = 5 V$

Typical AC Characteristics (continued)

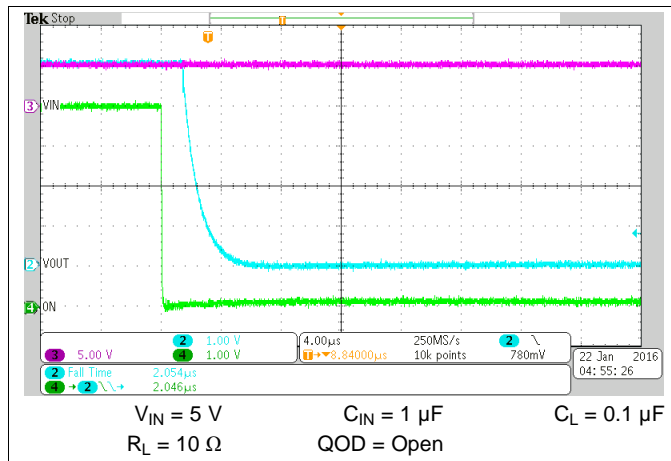

Figure 14. Fall Time (t_F) at $V_{IN} = 5\text{ V}$

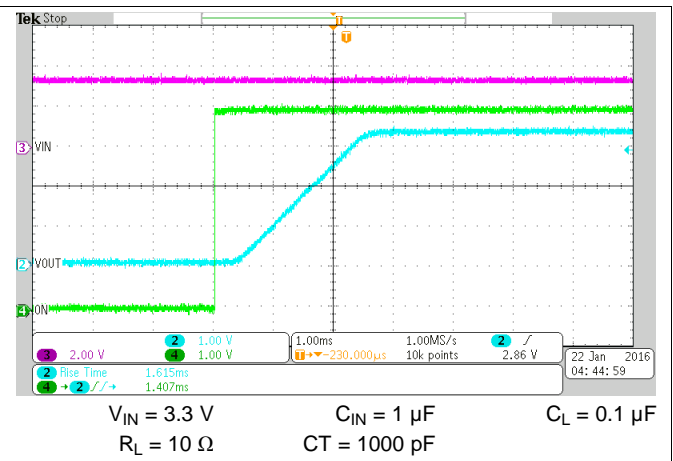

Figure 15. Rise Time (t_R) at $V_{IN} = 3.3\text{ V}$

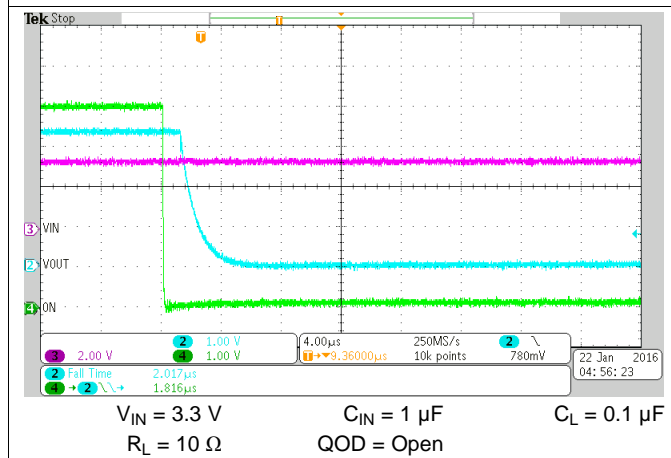

Figure 16. Fall Time (t_F) at $V_{IN} = 3.3\text{ V}$

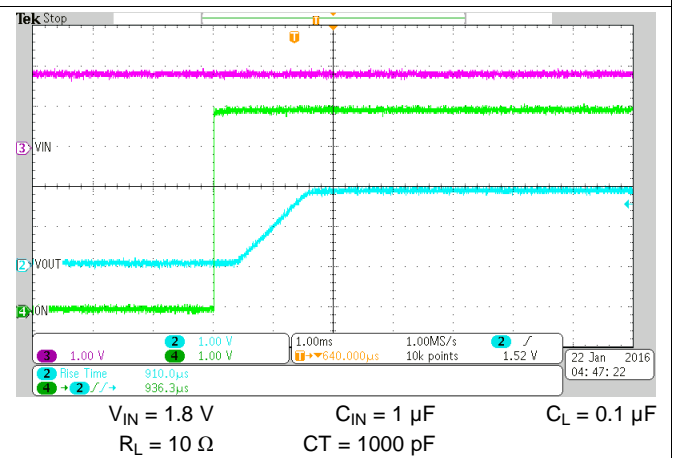

Figure 17. Rise Time (t_R) at $V_{IN} = 1.8\text{ V}$

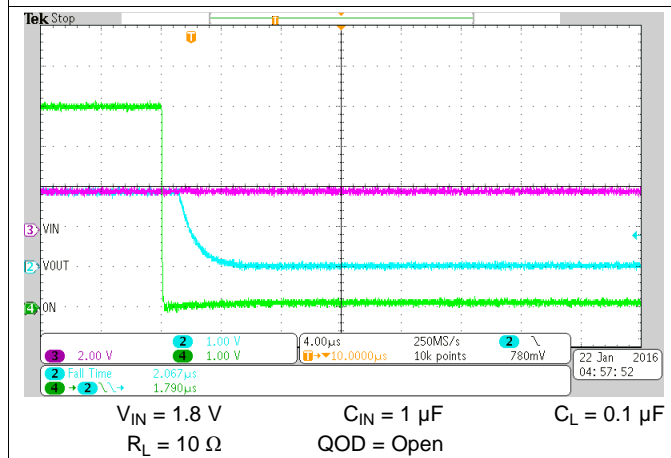

Figure 18. Fall Time (t_F) at $V_{IN} = 1.8\text{ V}$

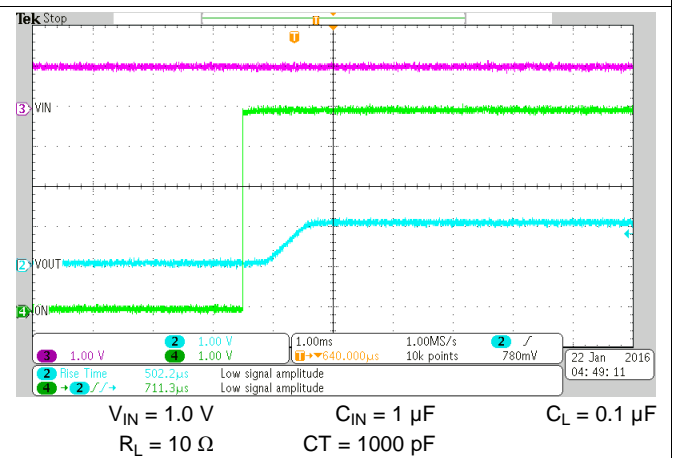
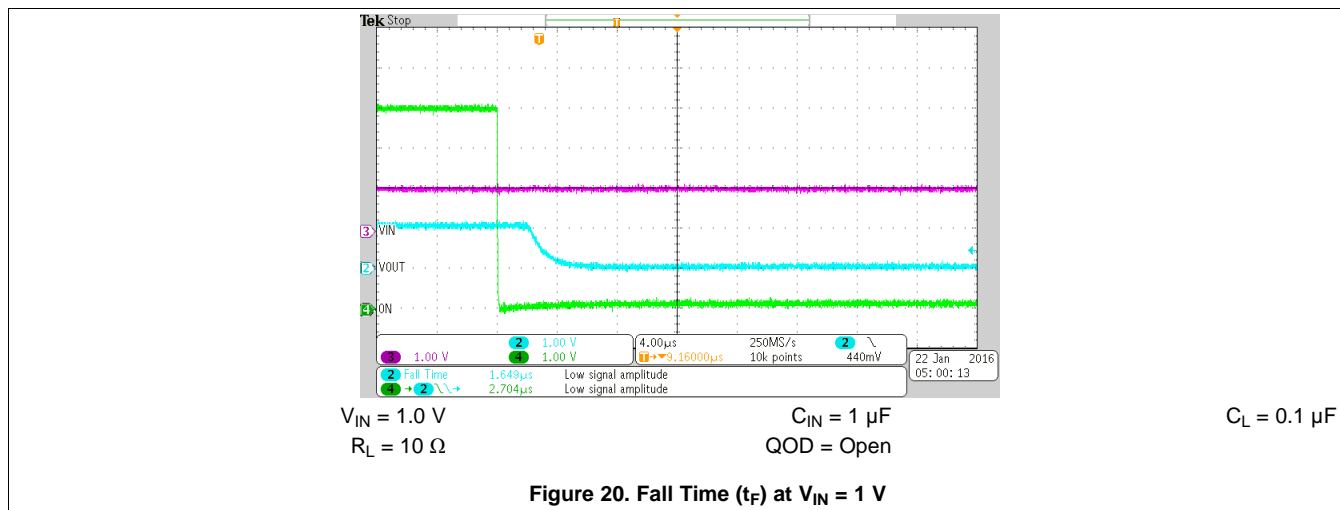
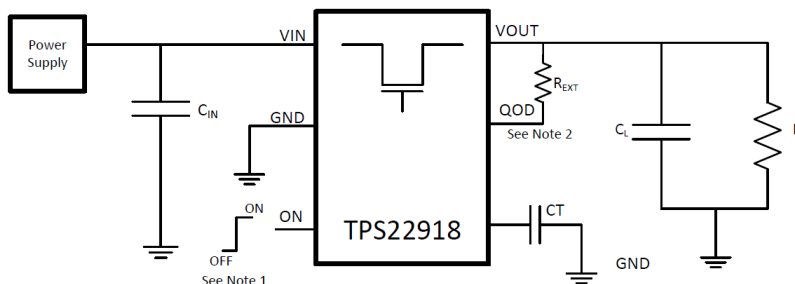

Figure 19. Rise Time (t_R) at $V_{IN} = 1\text{ V}$

Typical AC Characteristics (continued)



7 Parameter Measurement Information



- (1) Rise and fall times of the control signal are 100 ns
- (2) Turn-off times and fall times are dependent on the time constant at the load. For TPS22918, the internal pull-down resistance R_{PD} is enabled when the switch is disabled. The time constant is $(R_{QOD} \parallel R_L) \times C_L$.

Figure 21. Test Circuit

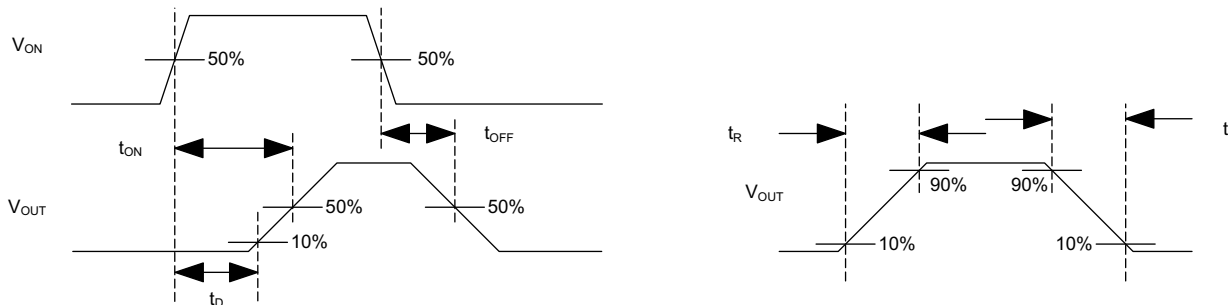

Figure 22. Timing Waveforms

8 Detailed Description

8.1 Overview

The TPS22918 is a 5.5-V, 2-A load switch in a 6-pin SOT-23 package. To reduce voltage drop for low voltage and high current rails, the device implements a low resistance N-channel MOSFET which reduces the drop out voltage across the device.

The device has a configurable slew rate which helps reduce or eliminate power supply droop because of large inrush currents. Furthermore, the device features a QOD pin, which allows the configuration of the discharge rate of VOUT once the switch is disabled. During shutdown, the device has very low leakage currents, thereby reducing unnecessary leakages for downstream modules during standby. Integrated control logic, driver, charge pump, and output discharge FET eliminates the need for any external components which reduces solution size and bill of materials (BOM) count.

8.2 Functional Block Diagram

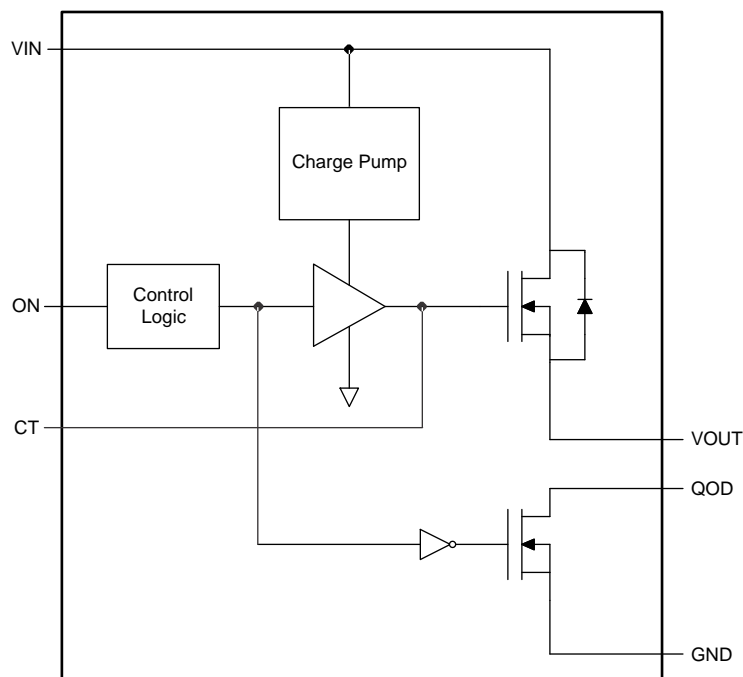

Copyright © 2016, Texas Instruments Incorporated

8.3 Feature Description

8.3.1 On and Off Control

The ON pin controls the state of the switch. ON is active high and has a low threshold, making it capable of interfacing with low-voltage signals. The ON pin is compatible with standard GPIO logic threshold. It can be used with any microcontroller with 1 V or higher GPIO voltage. This pin cannot be left floating and must be driven either high or low for proper functionality.

8.3.2 Quick Output Discharge (QOD)

The TPS22918 includes a QOD feature. The QOD pin can be configured in one of three ways:

- QOD pin shorted to VOUT pin. Using this method, the discharge rate after the switch becomes disabled is controlled with the value of the internal resistance R_{PD} . The value of this resistance is listed in the [Electrical Characteristics](#) table.
- QOD pin connected to VOUT pin using an external resistor R_{EXT} . After the switch becomes disabled, the discharge rate is controlled by the value of the total resistance of the QOD. To adjust the total QOD resistance, [Equation 1](#) can be used:

$$R_{QOD} = R_{PD} + R_{EXT}$$

Where:

- R_{QOD} = Total output discharge resistance
- R_{PD} = Internal pulldown resistance
- R_{EXT} = External resistance placed between the VOUT and QOD pin. (1)
- QOD pin is unused and left floating. Using this method, there will be no quick output discharge functionality, and the output will remain floating after the switch is disabled.

The fall times of the device depend on many factors including the total resistance of the QOD, V_{IN} , and the output capacitance. When QOD is shorted to VOUT, the fall time will change over V_{IN} as the internal R_{PD} varies over V_{IN} . To calculate the approximate fall time of V_{OUT} for a given R_{QOD} , use [Equation 2](#) and [Table 1](#).

$$V_{CAP} = V_{IN} \times e^{-t/\tau}$$

Where:

- V_{CAP} = Voltage across the capacitor (V)
- t = Time since power supply removal (s)
- τ = Time constant equal to $R_{QOD} \times C_L$ (2)

The fall times' dependency on V_{IN} becomes minimal as the QOD value increases with additional external resistance. See [Table 1](#) for QOD fall times.

Table 1. QOD Fall Times

V_{IN} (V)	⁽¹⁾ FALL TIME (μ s) 90% - 10%, $C_{IN} = 1 \mu$ F, $I_{OUT} = 0$ A, $V_{ON} = 0$ V					
	$T_A = 25^\circ$ C			$T_A = 85^\circ$ C		
	$C_L = 1 \mu$ F	$C_L = 10 \mu$ F	$C_L = 100 \mu$ F	$C_L = 1 \mu$ F	$C_L = 10 \mu$ F	$C_L = 100 \mu$ F
5.5	42	190	1880	40	210	2150
5	43	200	1905	45	220	2200
3.3	47	230	2150	50	260	2515
2.5	58	300	2790	60	345	3290
1.8	75	430	4165	80	490	4950
1.2	135	955	9910	135	1035	10980
1	230	1830	19625	210	1800	19270

(1) TYPICAL VALUES WITH QOD SHORTED TO VOUT

8.3.2.1 QOD when System Power is Removed

The adjustable QOD can be used to control the power down sequencing of a system even when the system power supply is removed. When the power is removed, the input capacitor discharges at V_{IN} . Past a certain V_{IN} level, the strength of the R_{PD} will be reduced. If there is still remaining charge on the output capacitor, this will result in longer fall times. For further information regarding this condition, see the [Shutdown Sequencing During Unexpected System Power Loss](#) section.

8.3.2.2 Internal QOD Considerations

Special considerations must be taken when using the internal R_{PD} by shorting the QOD pin to the VOUT pin. The internal R_{PD} is a pulldown resistance designed to quickly discharge a load after the switch has been disabled. Care must be used to ensure that excessive current does not flow through R_{PD} during discharge so that the maximum T_J of 125°C is not exceeded. When using only the internal R_{PD} to discharge a load, the total capacitive load must not exceed 200 μF . Otherwise, an external resistor, R_{EXT} , must be used to ensure the amount of current flowing through R_{PD} is properly limited and the maximum T_J is not exceeded. To ensure the device is not damaged, the remaining charge from C_L must decay naturally through the internal QOD resistance and should not be driven.

8.3.3 Adjustable Rise Time (CT)

A capacitor to GND on the CT pin sets the slew rate of V_{OUT} . The CT capacitor will charge up until shortly after the switch is turned on and V_{OUT} becomes stable. Once V_{OUT} become stable, the capacitor will discharge to ground. An approximate formula for the relationship between CT and the slew rate is shown in [Equation 3](#):

$$SR = 0.55 \times CT + 30$$

where

- SR = slew rate (in $\mu\text{s}/\text{V}$)
- CT = the capacitance value on the CT pin (in pF)
- The units for the constant 30 are $\mu\text{s}/\text{V}$. The units for the constant 0.55 are $\mu\text{s}/(\text{V} \times \text{pF})$. (3)

This equation accounts for 10% to 90% measurement on V_{OUT} and does not apply for $CT = 0$ pF. Use [Table 2](#) to determine rise times for when $CT = 0$ pF.

Rise time can be calculated by multiplying the input voltage by the slew rate. [Table 2](#) contains rise time values measured on a typical device.

Table 2. Rise Time Table

CTx (pF)	RISE TIME (μs) 10% - 90%, $C_L = 0.1 \mu\text{F}$, $C_{IN} = 1 \mu\text{F}$, $R_L = 10 \Omega$						
	VIN = 5 V	VN = 3.3 V	VIN = 2.5 V	VIN = 1.8 V	VIN = 1.5 V	VIN = 1.2 V	VIN = 1 V
0	135	95	75	60	50	45	40
220	650	455	350	260	220	185	160
470	1260	850	655	480	415	340	300
1000	2540	1680	1300	960	810	660	560
2200	5435	3580	2760	2020	1715	1390	1220
4700	12050	7980	6135	4485	3790	3120	2735
10000	26550	17505	13460	9790	8320	6815	5950

(1) Typical values at 25°C with a 25 V X7R 10% ceramic capacitor on CT.

As the voltage across the capacitor approaches the capacitor rated voltage, the effective capacitance reduces. Depending on the dielectric material used, the voltage coefficient changes. See [Table 3](#) for the recommended minimum voltage rating for the CT capacitor. If using $V_{IN} = 1.2$ V or 4 V, it is recommended to use the higher of the two CT Voltage ratings specified.

Table 3. Recommended CT Capacitor Voltage Rating

V_{IN} (V)	RECOMMENDED CT CAPACITOR VOLTAGE RATING (V)
1 V to 1.2 V	10
1.2 V to 4 V	16
4 V to 5.5 V	20

8.4 Device Functional Modes

Table 4 describes the connection of the VOUT pin depending on the state of the ON pin.

Table 4. VOUT Connection

ON	QOD CONFIGURATION	TPS22918 VOUT
L	QOD pin connected to VOUT with R_{EXT}	GND (via $R_{EXT}+R_{PD}$)
L	QOD pin tied to VOUT directly	GND (via R_{PD})
L	QOD pin left open	Open
H	Any valid QOD configuration	VIN

9 Application and Implementation

NOTE

Information in the following applications sections is not part of the TI component specification, and TI does not warrant its accuracy or completeness. TI's customers are responsible for determining suitability of components for their purposes. Customers should validate and test their design implementation to confirm system functionality.

9.1 Application Information

This section highlights some of the design considerations when implementing this device in various applications. A PSPICE model for this device is also available in the product page of this device on www.ti.com (See the [Device Support](#) section for more information).

9.2 Typical Application

This typical application demonstrates how the TPS22918 can be used to power downstream modules.

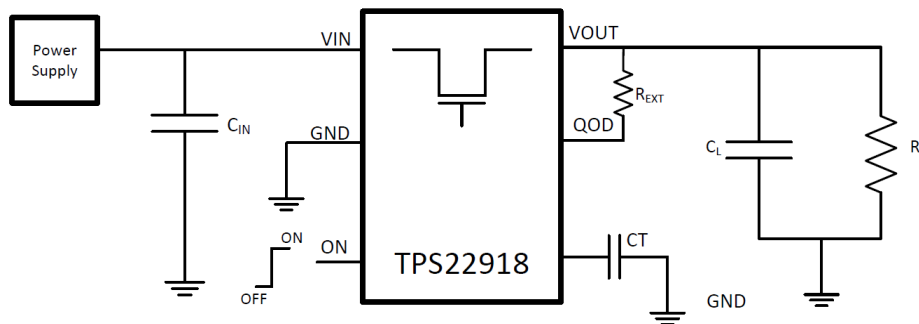

Figure 23. Typical Application Schematic

9.2.1 Design Requirements

For this design example, use the values listed in [Table 5](#) as the design parameters:

Table 5. Design Parameters

DESIGN PARAMETER	EXAMPLE VALUE
V_{IN}	5 V
Load Current	2 A
C_L	22 μ F
Desired Fall Time	4 ms
Maximum Acceptable Inrush Current	400 mA

9.2.2 Detailed Design Procedure

9.2.2.1 Input Capacitor (C_{IN})

To limit the voltage drop on the input supply caused by transient in-rush currents when the switch turns on into a discharged load capacitor or short-circuit, a capacitor needs to be placed between V_{IN} and GND. A 1 μ F ceramic capacitor, C_{IN} , placed close to the pins, is usually sufficient. Higher values of C_{IN} can be used to further reduce the voltage drop during high-current application. When switching heavy loads, it is recommended to have an input capacitor about 10 times higher than the output capacitor to avoid excessive voltage drop.

9.2.2.2 Output Capacitor (C_L) (Optional)

Because of the integrated body diode in the MOSFET, a C_{IN} greater than C_L is highly recommended. A C_L greater than C_{IN} can cause V_{OUT} to exceed V_{IN} when the system supply is removed. This could result in current flow through the body diode from V_{OUT} to V_{IN} . A C_{IN} to C_L ratio of 10 to 1 is recommended for minimizing V_{IN} dip caused by inrush currents during startup.

9.2.2.3 Shutdown Sequencing During Unexpected System Power Loss

Microcontrollers and processors often have a specific shutdown sequence in which power needs to be removed. Using the adjustable Quick Output Discharge function of the TPS22918, adding a load switch to each power rail can be used to manage the power down sequencing in the event of an unexpected system power loss (i.e. battery removal). To determine the QOD values for each load switch, first confirm the power down order of the device you wish to power sequence. Be sure to check if there are voltage or timing margins that must be maintained during power down. Next, consult QOD Fall Time Table in the [Quick Output Discharge \(QOD\)](#) feature description to determine appropriate C_{OUT} and R_{QOD} values for each power rail's load switch so that the load switches' fall times correspond to the order in which they need to be powered down. In the above example, we would like this power rail's fall time to be 4 ms. Using [Equation 2](#), to determine the appropriate R_{QOD} to achieve our desired fall time.

Because fall times are measured from 90% of V_{OUT} to 10% of V_{OUT} , the equation becomes:

$$.5 V = 4.5 V \times e^{-(4 \text{ ms}) / (R \times (22 \mu\text{F}))} \quad (4)$$

$$R_{QOD} = 83.333 \Omega \quad (5)$$

Refer to [Figure 7](#), R_{PD} at $V_{IN} = 5 V$ is approximately 25 Ω . Using [Equation 1](#), the required external QOD resistance can be calculated:

$$83.333 \Omega = 25 \Omega + R_{EXT} \quad (6)$$

$$R_{EXT} = 58.333 \Omega \quad (7)$$

[Figure 24](#) through [Figure 29](#) are scope shots demonstrating an example of the QOD functionality when power is removed from the device (both ON and V_{IN} are disconnected simultaneously). The input voltage is decaying in all scope shots below.

- Initial $V_{IN} = 3.3 V$
- QOD = Open, 500 Ω , or shorted to V_{OUT}
- $C_L = 1 \mu\text{F}$, 10 μF
- V_{OUT} is left floating

NOTE: V_{IN} may appear constant in some figures. This is because the time scale of the scope shot is too small to show the decay of C_{IN} .

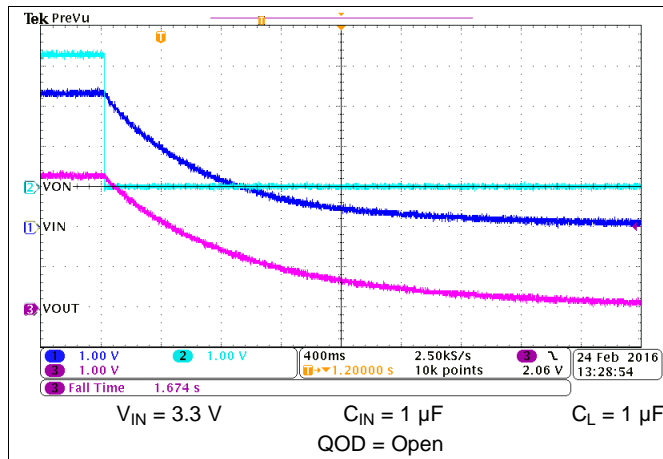

Figure 24. Fall Time (t_F) at $V_{IN} = 3.3\text{ V}$

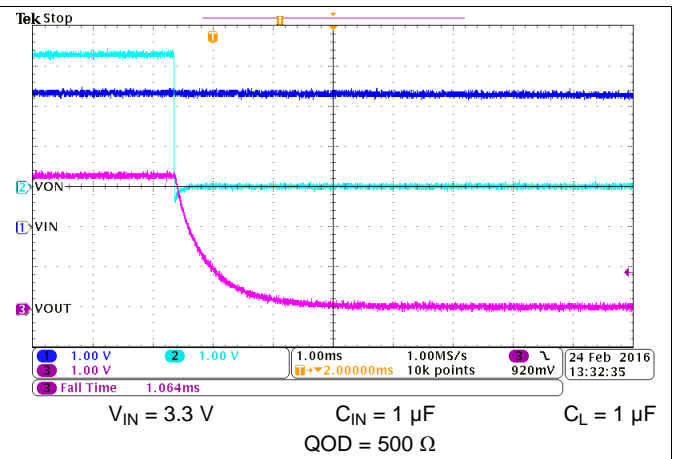

Figure 25. Fall Time (t_F) at $V_{IN} = 3.3\text{ V}$

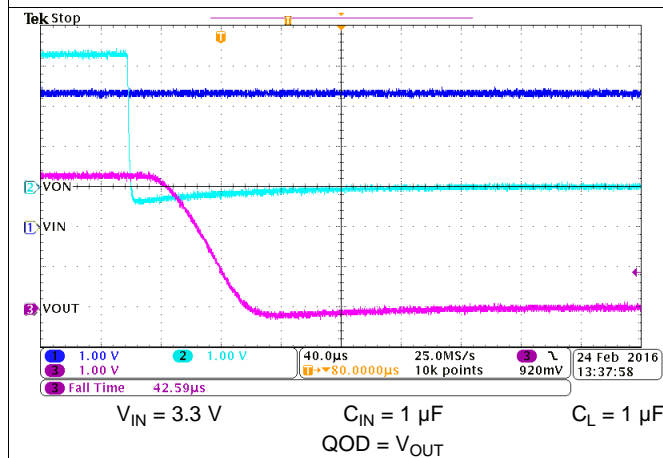

Figure 26. Fall Time (t_F) at $V_{IN} = 3.3\text{ V}$

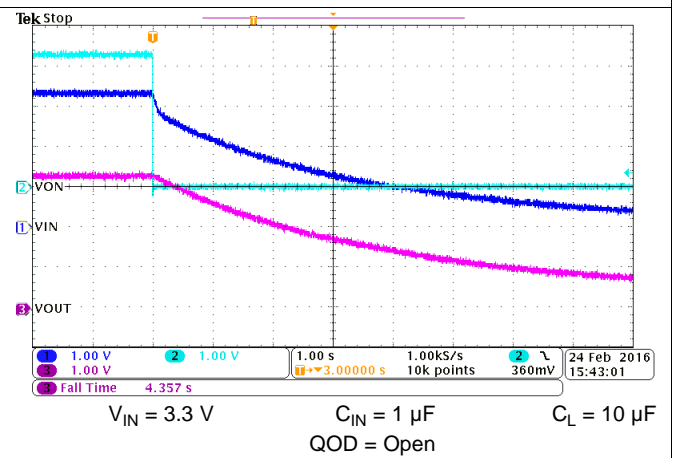

Figure 27. Fall Time (t_F) at $V_{IN} = 3.3\text{ V}$

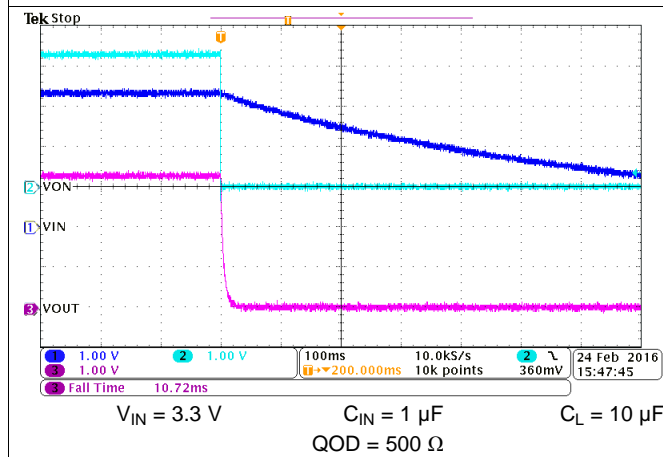

Figure 28. Fall Time (t_F) at $V_{IN} = 3.3\text{ V}$

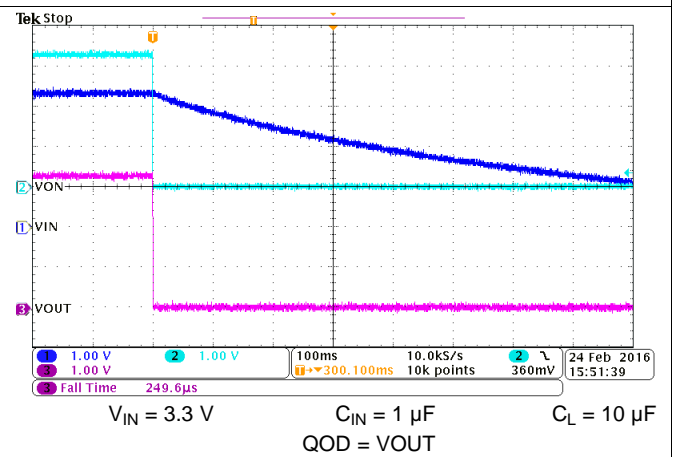

Figure 29. Fall Time (t_F) at $V_{IN} = 3.3\text{ V}$

9.2.2.4 VIN to VOUT Voltage Drop

The VIN to VOUT voltage drop in the device is determined by the R_{ON} of the device and the load current. The R_{ON} of the device depends upon the VIN conditions of the device. Refer to the R_{ON} specification of the device in the [Electrical Characteristics](#) table of this data sheet. When the R_{ON} of the device is determined based upon the VIN conditions, use [Equation 8](#) to calculate the VIN to VOUT voltage drop:

$$\Delta V = I_{LOAD} \times R_{ON}$$

where

- ΔV = voltage drop from VIN to VOUT
- I_{LOAD} = load current
- R_{ON} = On-resistance of the device for a specific V_{IN}

An appropriate I_{LOAD} must be chosen such that the I_{MAX} specification of the device is not violated. (8)

9.2.2.5 Inrush Current

Use [Equation 9](#) to determine how much inrush current will be caused by the C_L capacitor:

$$I_{INRUSH} = C_L \times \frac{dV_{OUT}}{dt}$$

where

- I_{INRUSH} = amount of inrush caused by C_L
- C_L = capacitance on VOUT
- dt = Output Voltage rise time during the ramp up of VOUT when the device is enabled
- dV_{OUT} = change in V_{OUT} during the ramp up of VOUT when the device is enabled (9)

The appropriate rise time can be calculated using the design requirements and the inrush current equation. As we are calculating the rise time (measured from 10% to 90% of V_{OUT}), we will account for this in our dV_{OUT} parameter (80% of $V_{OUT} = 4$ V).

$$400 \text{ mA} = 22 \text{ pF} \times 4 \text{ V}/dt \quad (10)$$

$$dt = 220 \text{ } \mu\text{s} \quad (11)$$

To ensure an inrush current of less than 400 mA, choose a C_T value that will yield a rise time of more than 220 μs . Consulting [Table 2](#) at $V_{IN} = 5$ V, $C_T = 220$ pF will provide a typical rise time of 650 μs . Inputting this rise time and voltage into [Equation 9](#), yields:

$$I_{Inrush} = 22 \text{ pF} \times 4 \text{ V} / 650 \text{ } \mu\text{s} \quad (12)$$

$$I_{Inrush} = 135 \text{ mA} \quad (13)$$

This inrush current can be seen in the [Application Curves](#) section. An appropriate C_L value should be placed on VOUT such that the I_{MAX} and I_{PLS} specifications of the device are not violated.

9.2.3 Application Curves

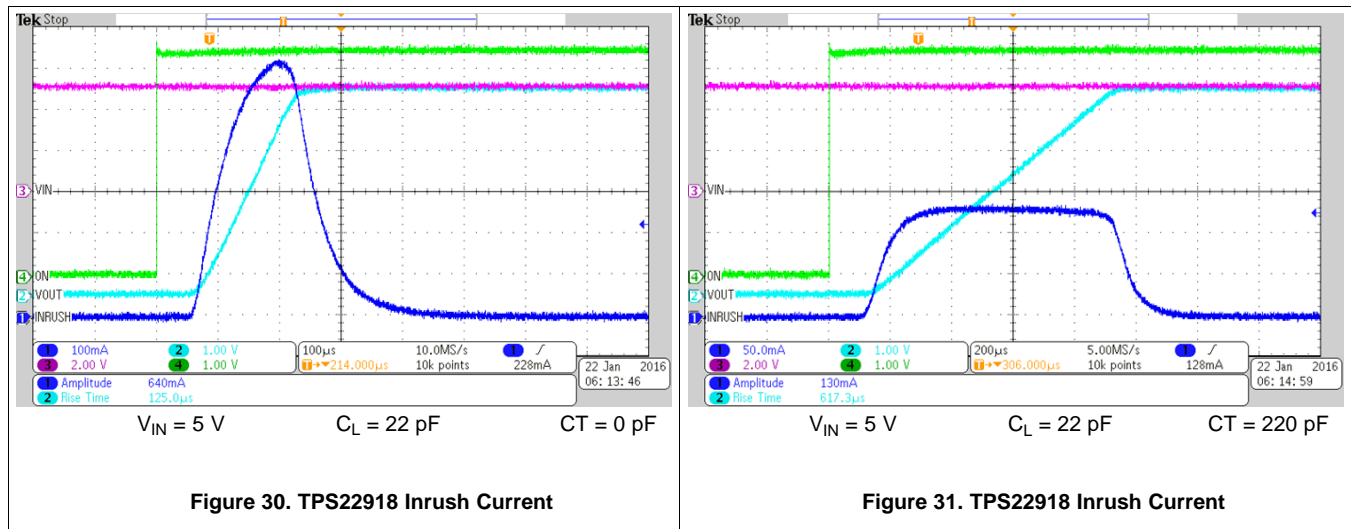

10 Power Supply Recommendations

The device is designed to operate from a V_{IN} range of 1 V to 5.5 V. This supply must be well regulated and placed as close to the device terminal as possible with the recommended 1- μF bypass capacitor. If the supply is located more than a few inches from the device terminals, additional bulk capacitance may be required in addition to the ceramic bypass capacitors. If additional bulk capacitance is required, an electrolytic, tantalum, or ceramic capacitor of 1 μF may be sufficient.

The TPS22918 operates regardless of power sequencing order. The order in which voltages are applied to V_{IN} and ON will not damage the device as long as the voltages do not exceed the absolute maximum operating conditions. If voltage is applied to ON before V_{IN} , the slew rate of V_{OUT} will not be controlled.

11 Layout

11.1 Layout Guidelines

V_{IN} and V_{OUT} traces should be as short and wide as possible to accommodate for high current.

The V_{IN} pin should be bypassed to ground with low ESR ceramic bypass capacitors. The typical recommended bypass capacitance is 1- μF ceramic with X5R or X7R dielectric. This capacitor must be placed as close to the device pins as possible.

11.2 Layout Example

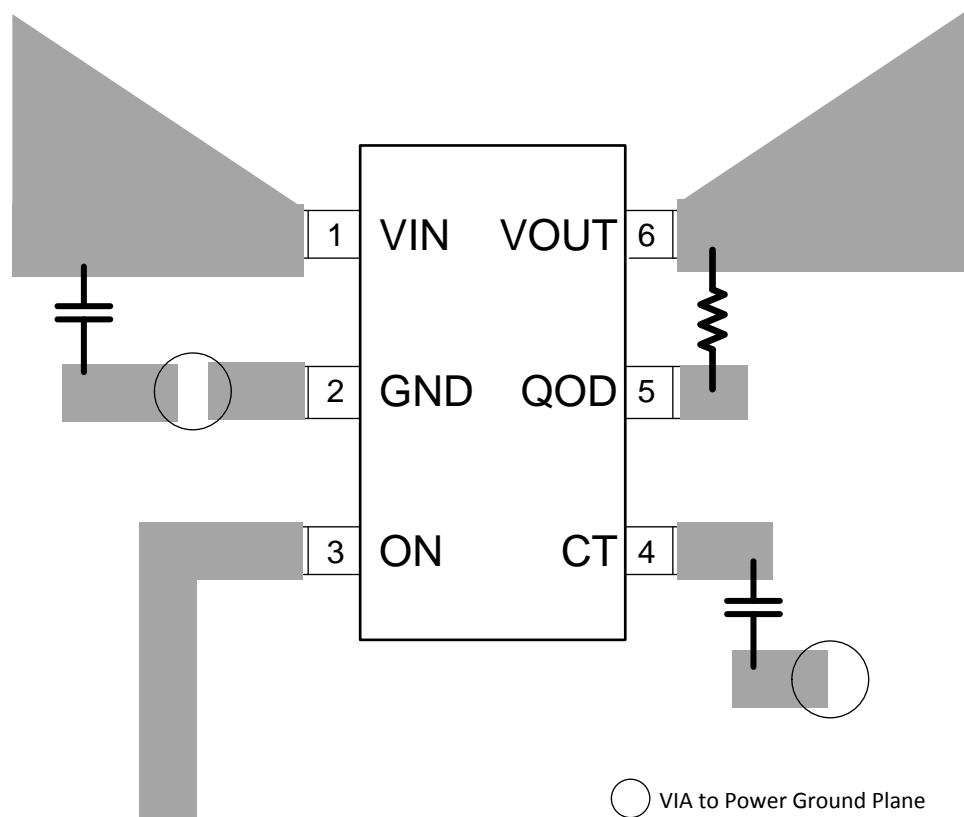

Figure 32. Recommended Board Layout

11.3 Thermal Considerations

For best performance, all traces must be as short as possible. To be most effective, the input and output capacitors must be placed close to the device to minimize the effects that parasitic trace inductances may have on normal and short-circuit operation. Using wide traces for VIN, VOUT, and GND helps minimize the parasitic electrical effects along with minimizing the case to ambient thermal impedance.

The maximum IC junction temperature should be restricted to 125°C under normal operating conditions. To calculate the maximum allowable dissipation, $P_{D(max)}$ for a given output current and ambient temperature, use Equation 14:

$$P_{D(MAX)} = \frac{T_{J(MAX)} - T_A}{\theta_{JA}}$$

where

- $P_{D(MAX)}$ = maximum allowable power dissipation
- $T_{J(MAX)}$ = maximum allowable junction temperature (125°C for the TPS22918)
- T_A = ambient temperature of the device
- θ_{JA} = junction to air thermal impedance. Refer to the [Thermal Information](#) table. This parameter is highly dependent upon board layout. (14)

12 Device and Documentation Support

12.1 Device Support

12.1.1 Developmental Support

For the TPS22918 PSpice Transient Model, see [SLVMBI6](#).

12.2 Documentation Support

12.2.1 Related Documentation

For related documentation see the following:

TPS22918 5.5-V, 2-A, 50-mΩ On-Resistance Load Switch Evaluation Module, [SLVUAP0](#).

12.3 Community Resources

The following links connect to TI community resources. Linked contents are provided "AS IS" by the respective contributors. They do not constitute TI specifications and do not necessarily reflect TI's views; see TI's [Terms of Use](#).

TI E2E™ Online Community *TI's Engineer-to-Engineer (E2E) Community*. Created to foster collaboration among engineers. At [e2e.ti.com](#), you can ask questions, share knowledge, explore ideas and help solve problems with fellow engineers.

Design Support *TI's Design Support* Quickly find helpful E2E forums along with design support tools and contact information for technical support.

12.4 Trademarks

E2E is a trademark of Texas Instruments.
All other trademarks are the property of their respective owners.

12.5 Electrostatic Discharge Caution



These devices have limited built-in ESD protection. The leads should be shorted together or the device placed in conductive foam during storage or handling to prevent electrostatic damage to the MOS gates.

12.6 Glossary

[SLYZ022](#) — *TI Glossary*.

This glossary lists and explains terms, acronyms, and definitions.

13 Mechanical, Packaging, and Orderable Information

The following pages include mechanical, packaging, and orderable information. This information is the most current data available for the designated devices. This data is subject to change without notice and revision of this document. For browser-based versions of this data sheet, refer to the left-hand navigation.

PACKAGING INFORMATION

Orderable Device	Status (1)	Package Type	Package Drawing	Pins	Package Qty	Eco Plan (2)	Lead finish/ Ball material (6)	MSL Peak Temp (3)	Op Temp (°C)	Device Marking (4/5)	Samples
TPS22918DBVR	ACTIVE	SOT-23	DBV	6	3000	RoHS & Green	NIPDAU SN	Level-2-260C-1 YEAR	-40 to 105	13MW	Samples
TPS22918DBVT	ACTIVE	SOT-23	DBV	6	250	RoHS & Green	NIPDAU SN	Level-2-260C-1 YEAR	-40 to 105	13MW	Samples

(1) The marketing status values are defined as follows:

ACTIVE: Product device recommended for new designs.

LIFEBUY: TI has announced that the device will be discontinued, and a lifetime-buy period is in effect.

NRND: Not recommended for new designs. Device is in production to support existing customers, but TI does not recommend using this part in a new design.

PREVIEW: Device has been announced but is not in production. Samples may or may not be available.

OBSOLETE: TI has discontinued the production of the device.

(2) **RoHS:** TI defines "RoHS" to mean semiconductor products that are compliant with the current EU RoHS requirements for all 10 RoHS substances, including the requirement that RoHS substance do not exceed 0.1% by weight in homogeneous materials. Where designed to be soldered at high temperatures, "RoHS" products are suitable for use in specified lead-free processes. TI may reference these types of products as "Pb-Free".

RoHS Exempt: TI defines "RoHS Exempt" to mean products that contain lead but are compliant with EU RoHS pursuant to a specific EU RoHS exemption.

Green: TI defines "Green" to mean the content of Chlorine (Cl) and Bromine (Br) based flame retardants meet JS709B low halogen requirements of <=1000ppm threshold. Antimony trioxide based flame retardants must also meet the <=1000ppm threshold requirement.

(3) MSL, Peak Temp. - The Moisture Sensitivity Level rating according to the JEDEC industry standard classifications, and peak solder temperature.

(4) There may be additional marking, which relates to the logo, the lot trace code information, or the environmental category on the device.

(5) Multiple Device Markings will be inside parentheses. Only one Device Marking contained in parentheses and separated by a "~" will appear on a device. If a line is indented then it is a continuation of the previous line and the two combined represent the entire Device Marking for that device.

(6) Lead finish/Ball material - Orderable Devices may have multiple material finish options. Finish options are separated by a vertical ruled line. Lead finish/Ball material values may wrap to two lines if the finish value exceeds the maximum column width.

Important Information and Disclaimer:The information provided on this page represents TI's knowledge and belief as of the date that it is provided. TI bases its knowledge and belief on information provided by third parties, and makes no representation or warranty as to the accuracy of such information. Efforts are underway to better integrate information from third parties. TI has taken and continues to take reasonable steps to provide representative and accurate information but may not have conducted destructive testing or chemical analysis on incoming materials and chemicals. TI and TI suppliers consider certain information to be proprietary, and thus CAS numbers and other limited information may not be available for release.

In no event shall TI's liability arising out of such information exceed the total purchase price of the TI part(s) at issue in this document sold by TI to Customer on an annual basis.

OTHER QUALIFIED VERSIONS OF TPS22918 :

- Automotive: [TPS22918-Q1](#)

NOTE: Qualified Version Definitions:

- Automotive - Q100 devices qualified for high-reliability automotive applications targeting zero defects

TAPE AND REEL INFORMATION



QUADRANT ASSIGNMENTS FOR PIN 1 ORIENTATION IN TAPE



*All dimensions are nominal

Device	Package Type	Package Drawing	Pins	SPQ	Reel Diameter (mm)	Reel Width W1 (mm)	A0 (mm)	B0 (mm)	K0 (mm)	P1 (mm)	W (mm)	Pin1 Quadrant
TPS22918DBVR	SOT-23	DBV	6	3000	180.0	8.4	3.2	3.2	1.4	4.0	8.0	Q3
TPS22918DBVR	SOT-23	DBV	6	3000	178.0	9.0	3.23	3.17	1.37	4.0	8.0	Q3
TPS22918DBVT	SOT-23	DBV	6	250	178.0	9.0	3.23	3.17	1.37	4.0	8.0	Q3
TPS22918DBVT	SOT-23	DBV	6	250	180.0	8.4	3.2	3.2	1.4	4.0	8.0	Q3

TAPE AND REEL BOX DIMENSIONS



*All dimensions are nominal

Device	Package Type	Package Drawing	Pins	SPQ	Length (mm)	Width (mm)	Height (mm)
TPS22918DBVR	SOT-23	DBV	6	3000	210.0	185.0	35.0
TPS22918DBVR	SOT-23	DBV	6	3000	190.0	190.0	30.0
TPS22918DBVT	SOT-23	DBV	6	250	190.0	190.0	30.0
TPS22918DBVT	SOT-23	DBV	6	250	210.0	185.0	35.0

DBV0006A



PACKAGE OUTLINE

SOT-23 - 1.45 mm max height

SMALL OUTLINE TRANSISTOR



4214840/C 06/2021

NOTES:

1. All linear dimensions are in millimeters. Any dimensions in parenthesis are for reference only. Dimensioning and tolerancing per ASME Y14.5M.
2. This drawing is subject to change without notice.
3. Body dimensions do not include mold flash or protrusion. Mold flash and protrusion shall not exceed 0.25 per side.
4. Leads 1,2,3 may be wider than leads 4,5,6 for package orientation.
5. Reference JEDEC MO-178.

EXAMPLE BOARD LAYOUT

DBV0006A

SOT-23 - 1.45 mm max height

SMALL OUTLINE TRANSISTOR



LAND PATTERN EXAMPLE
EXPOSED METAL SHOWN
SCALE:15X



SOLDER MASK DETAILS

4214840/C 06/2021

NOTES: (continued)

- 6. Publication IPC-7351 may have alternate designs.
- 7. Solder mask tolerances between and around signal pads can vary based on board fabrication site.

EXAMPLE STENCIL DESIGN

DBV0006A

SOT-23 - 1.45 mm max height

SMALL OUTLINE TRANSISTOR



SOLDER PASTE EXAMPLE
BASED ON 0.125 mm THICK STENCIL
SCALE:15X

4214840/C 06/2021

NOTES: (continued)

8. Laser cutting apertures with trapezoidal walls and rounded corners may offer better paste release. IPC-7525 may have alternate design recommendations.
9. Board assembly site may have different recommendations for stencil design.

IMPORTANT NOTICE AND DISCLAIMER

TI PROVIDES TECHNICAL AND RELIABILITY DATA (INCLUDING DATASHEETS), DESIGN RESOURCES (INCLUDING REFERENCE DESIGNS), APPLICATION OR OTHER DESIGN ADVICE, WEB TOOLS, SAFETY INFORMATION, AND OTHER RESOURCES "AS IS" AND WITH ALL FAULTS, AND DISCLAIMS ALL WARRANTIES, EXPRESS AND IMPLIED, INCLUDING WITHOUT LIMITATION ANY IMPLIED WARRANTIES OF MERCHANTABILITY, FITNESS FOR A PARTICULAR PURPOSE OR NON-INFRINGEMENT OF THIRD PARTY INTELLECTUAL PROPERTY RIGHTS.

These resources are intended for skilled developers designing with TI products. You are solely responsible for (1) selecting the appropriate TI products for your application, (2) designing, validating and testing your application, and (3) ensuring your application meets applicable standards, and any other safety, security, or other requirements. These resources are subject to change without notice. TI grants you permission to use these resources only for development of an application that uses the TI products described in the resource. Other reproduction and display of these resources is prohibited. No license is granted to any other TI intellectual property right or to any third party intellectual property right. TI disclaims responsibility for, and you will fully indemnify TI and its representatives against, any claims, damages, costs, losses, and liabilities arising out of your use of these resources.

TI's products are provided subject to TI's Terms of Sale (<https://www.ti.com/legal/termsofsale.html>) or other applicable terms available either on [ti.com](https://www.ti.com) or provided in conjunction with such TI products. TI's provision of these resources does not expand or otherwise alter TI's applicable warranties or warranty disclaimers for TI products.

Mailing Address: Texas Instruments, Post Office Box 655303, Dallas, Texas 75265
Copyright © 2021, Texas Instruments Incorporated