

General Description

- Latest AlphaIGBT (αIGBT) technology
- 650V breakdown voltage
- Very fast and soft recovery freewheeling diode
- High efficient turn-on di/dt controllability
- Low $V_{CE(sat)}$ enables high efficiencies
- Low turn-off switching loss and softness
- Very good EMI behavior
- High short-circuit ruggedness

Applications

- Motor Drives
- Home appliance applications such as refrigerators and washing machines
- Fan, Pumps, Vacuum Cleaner
- Other Hard Switching Applications

Product Summary

| | |
|--|-------|
| V_{CE} | 650V |
| I_C ($T_C=100^\circ\text{C}$) | 5A |
| $V_{CE(sat)}$ ($T_J=25^\circ\text{C}$) | 1.57V |

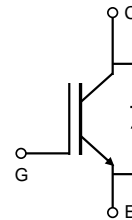
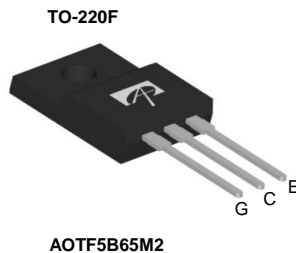

| Orderable Part Number | Package Type | Form | Minimum Order Quantity |
|-----------------------|--------------|------|------------------------|
| AOTF5B65M2 | TO220F | Tube | 1000 |

Absolute Maximum Ratings $T_A=25^\circ\text{C}$ unless otherwise noted

| Parameter | Symbol | AOTF5B65M2 | Units |
|---|----------------|-------------------------|------------------|
| Collector-Emitter Voltage | V_{CE} | 650 | V |
| Gate-Emitter Voltage | V_{GE} | ± 30 | V |
| Continuous Collector Current | I_C | $T_C=25^\circ\text{C}$ | $10^{(2)}$ |
| | | $T_C=100^\circ\text{C}$ | $5^{(2)}$ |
| Pulsed Collector Current, Limited by T_{Jmax} | I_{CM} | 15 | A |
| Turn off SOA, $V_{CE} \leq 650\text{V}$, Limited by T_{Jmax} | I_{LM} | 15 | A |
| Continuous Diode Forward Current | I_F | $T_C=25^\circ\text{C}$ | $10^{(2)}$ |
| | | $T_C=100^\circ\text{C}$ | $5^{(2)}$ |
| Diode Pulsed Current, Limited by T_{Jmax} | I_{FM} | 15 | A |
| Short circuit withstanding time ¹⁾ $V_{GE}=15\text{V}$, $V_{CC} \leq 400\text{V}$, $T_J \leq 150^\circ\text{C}$ | t_{SC} | 5 | μs |
| Power Dissipation | P_D | $T_C=25^\circ\text{C}$ | 25 |
| | | $T_C=100^\circ\text{C}$ | 10 |
| Junction and Storage Temperature Range | T_J, T_{STG} | -55 to 150 | $^\circ\text{C}$ |
| Maximum lead temperature for soldering purpose, 1/8" from case for 5 seconds | T_L | 300 | $^\circ\text{C}$ |

Thermal Characteristics

| Parameter | Symbol | AOTF5B65M2 | Units |
|--------------------------------|-----------------|------------|--------------------|
| Maximum Junction-to-Ambient | $R_{\theta JA}$ | 65 | $^\circ\text{C/W}$ |
| Maximum IGBT Junction-to-Case | $R_{\theta JC}$ | 5 | $^\circ\text{C/W}$ |
| Maximum Diode Junction-to-Case | $R_{\theta JC}$ | 7 | $^\circ\text{C/W}$ |

1) Allowed number of short circuits: <1000; time between short circuits: >1s.

2) TO220F I_C follows TO220/TO263.

Electrical Characteristics (T_J=25°C unless otherwise noted)

| Symbol | Parameter | Conditions | Min | Typ | Max | Units | |
|--|--------------------------------------|---|---|------|-----------|----------|---------|
| STATIC PARAMETERS | | | | | | | |
| BV_{CES} | Collector-Emitter Breakdown Voltage | $I_C=1mA, V_{GE}=0V, T_J=25^\circ C$ | 650 | - | - | V | |
| $V_{CE(sat)}$ | Collector-Emitter Saturation Voltage | $V_{GE}=15V, I_C=5A$ | $T_J=25^\circ C$ | - | 1.57 | 1.98 | V |
| | | | $T_J=125^\circ C$ | - | 1.87 | - | |
| | | | $T_J=150^\circ C$ | - | 1.95 | - | |
| V_F | Diode Forward Voltage | $V_{GE}=0V, I_C=5A$ | $T_J=25^\circ C$ | - | 1.48 | 1.9 | V |
| | | | $T_J=125^\circ C$ | - | 1.49 | - | |
| | | | $T_J=150^\circ C$ | - | 1.46 | - | |
| $V_{GE(th)}$ | Gate-Emitter Threshold Voltage | $V_{CE}=5V, I_C=1mA$ | - | 5.1 | - | V | |
| I_{CES} | Zero Gate Voltage Collector Current | $V_{CE}=650V, V_{GE}=0V$ | $T_J=25^\circ C$ | - | - | 10 | μA |
| | | | $T_J=125^\circ C$ | - | - | 100 | |
| | | | $T_J=150^\circ C$ | - | - | 500 | |
| I_{GES} | Gate-Emitter leakage current | $V_{CE}=0V, V_{GE}=\pm 30V$ | - | - | ± 100 | nA | |
| g_{FS} | Forward Transconductance | $V_{CE}=20V, I_C=5A$ | - | 4.1 | - | S | |
| DYNAMIC PARAMETERS | | | | | | | |
| C_{ies} | Input Capacitance | $V_{GE}=0V, V_{CC}=25V, f=1MHz$ | - | 348 | - | pF | |
| C_{oes} | Output Capacitance | | - | 40 | - | pF | |
| C_{res} | Reverse Transfer Capacitance | | - | 13 | - | pF | |
| Q_g | Total Gate Charge | $V_{GE}=15V, V_{CC}=520V, I_C=5A$ | - | 14 | - | nC | |
| Q_{ge} | Gate to Emitter Charge | | - | 3 | - | nC | |
| Q_{gc} | Gate to Collector Charge | | - | 6.5 | - | nC | |
| $I_{C(SC)}$ | Short circuit collector current | $V_{GE}=15V, V_{CC}=400V,$ $t_{sc} \leq 5\mu s, T_J \leq 150^\circ C$ | - | 30 | - | A | |
| R_g | Gate resistance | $V_{GE}=0V, V_{CC}=0V, f=1MHz$ | - | 6 | - | Ω | |
| SWITCHING PARAMETERS, (Load Inductive, T_J=25°C) | | | | | | | |
| $t_{D(on)}$ | Turn-On DelayTime | $T_J=25^\circ C$ $V_{GE}=15V, V_{CC}=400V, I_C=5A,$ $R_G=60\Omega$ | - | 8.5 | - | ns | |
| t_r | Turn-On Rise Time | | - | 13 | - | ns | |
| $t_{D(off)}$ | Turn-Off Delay Time | | - | 106 | - | ns | |
| t_f | Turn-Off Fall Time | | - | 18 | - | ns | |
| E_{on} | Turn-On Energy | | - | 0.08 | - | mJ | |
| E_{off} | Turn-Off Energy | | - | 0.07 | - | mJ | |
| E_{total} | Total Switching Energy | | - | 0.15 | - | mJ | |
| t_{rr} | Diode Reverse Recovery Time | | $T_J=25^\circ C$ | - | 173 | - | ns |
| Q_{rr} | Diode Reverse Recovery Charge | | $I_F=5A, di/dt=200A/\mu s, V_{CC}=400V$ | - | 0.27 | - | μC |
| I_{rm} | Diode Peak Reverse Recovery Current | | | - | 3.5 | - | A |
| SWITCHING PARAMETERS, (Load Inductive, T_J=150°C) | | | | | | | |
| $t_{D(on)}$ | Turn-On DelayTime | $T_J=150^\circ C$ $V_{GE}=15V, V_{CC}=400V, I_C=5A,$ $R_G=60\Omega$ | - | 7 | - | ns | |
| t_r | Turn-On Rise Time | | - | 14 | - | ns | |
| $t_{D(off)}$ | Turn-Off Delay Time | | - | 127 | - | ns | |
| t_f | Turn-Off Fall Time | | - | 30 | - | ns | |
| E_{on} | Turn-On Energy | | - | 0.09 | - | mJ | |
| E_{off} | Turn-Off Energy | | - | 0.12 | - | mJ | |
| E_{total} | Total Switching Energy | | - | 0.21 | - | mJ | |
| t_{rr} | Diode Reverse Recovery Time | | $T_J=150^\circ C$ | - | 273 | - | ns |
| Q_{rr} | Diode Reverse Recovery Charge | | $I_F=5A, di/dt=200A/\mu s, V_{CC}=400V$ | - | 0.48 | - | μC |
| I_{rm} | Diode Peak Reverse Recovery Current | | | - | 4.4 | - | A |

APPLICATIONS OR USES AS CRITICAL COMPONENTS IN LIFE SUPPORT DEVICES OR SYSTEMS ARE NOT AUTHORIZED. AOS DOES NOT ASSUME ANY LIABILITY ARISING OUT OF SUCH APPLICATIONS OR USES OF ITS PRODUCTS. AOS RESERVES THE RIGHT TO MAKE CHANGES TO PRODUCT SPECIFICATIONS WITHOUT NOTICE. IT IS THE RESPONSIBILITY OF THE CUSTOMER TO EVALUATE SUITABILITY OF THE PRODUCT FOR THEIR INTENDED APPLICATION. CUSTOMER SHALL COMPLY WITH APPLICABLE LEGAL REQUIREMENTS, INCLUDING ALL APPLICABLE EXPORT CONTROL RULES, REGULATIONS AND LIMITATIONS.

AOS' products are provided subject to AOS' terms and conditions of sale which are set forth at:
http://www.aosmd.com/terms_and_conditions_of_sale

TYPICAL ELECTRICAL AND THERMAL CHARACTERISTICS

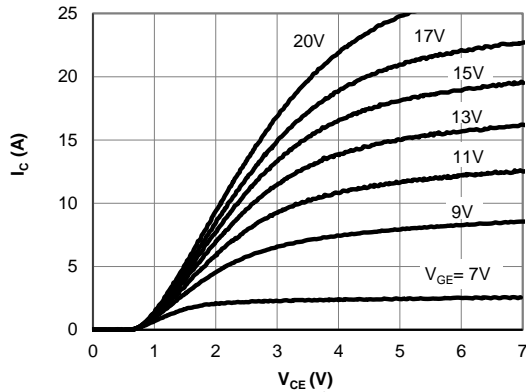

Figure 1: Output Characteristic
($T_j=25^\circ\text{C}$)

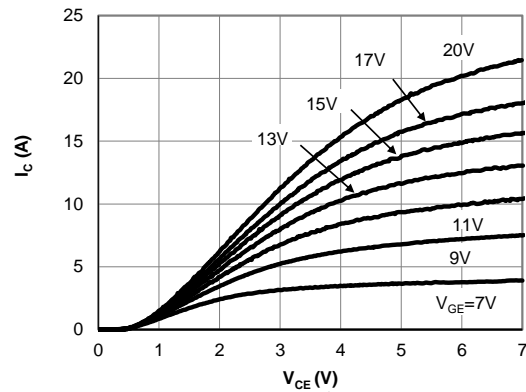

Figure 2: Output Characteristic
($T_j=150^\circ\text{C}$)

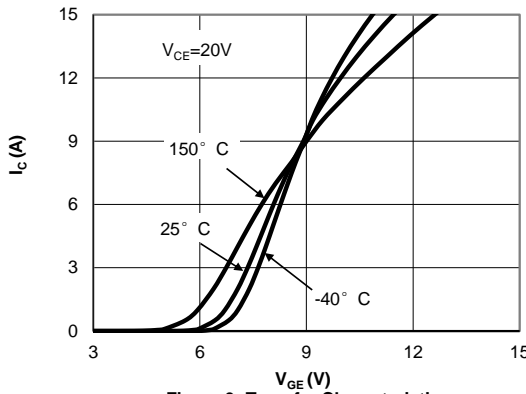

Figure 3: Transfer Characteristic

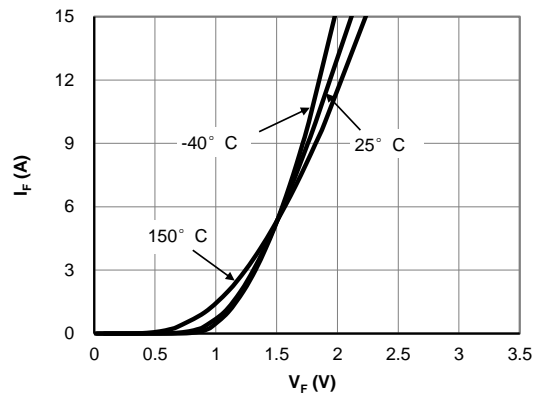

Figure 4: Diode Characteristic

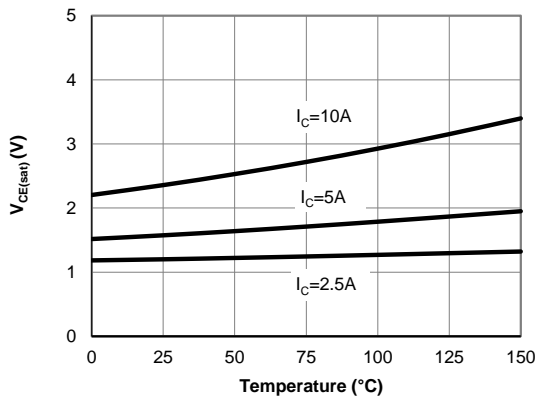

Figure 5: Collector-Emitter Saturation Voltage vs. Junction Temperature

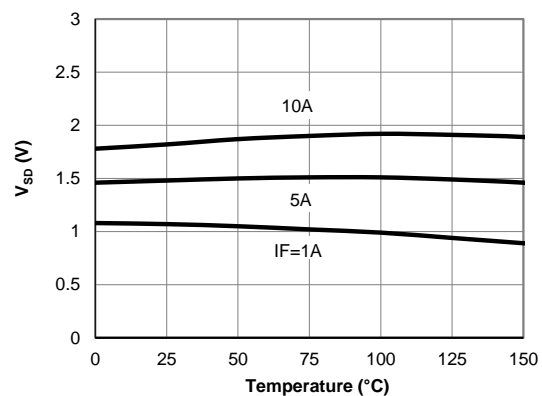

Figure 6: Diode Forward voltage vs. Junction Temperature

TYPICAL ELECTRICAL AND THERMAL CHARACTERISTICS

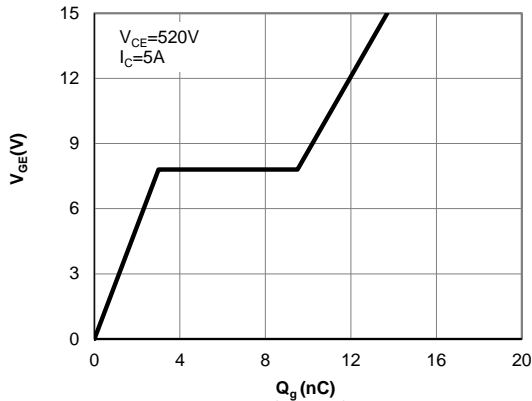

Figure 7: Gate-Charge Characteristics

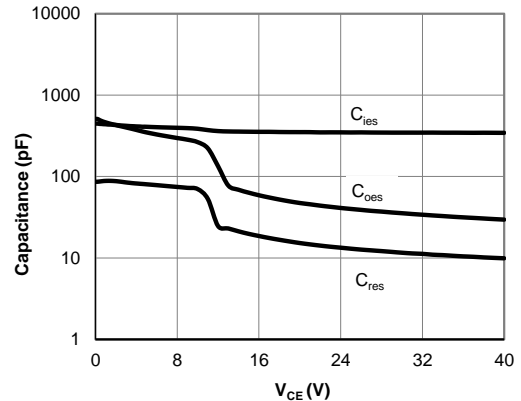

Figure 8: Capacitance Characteristic

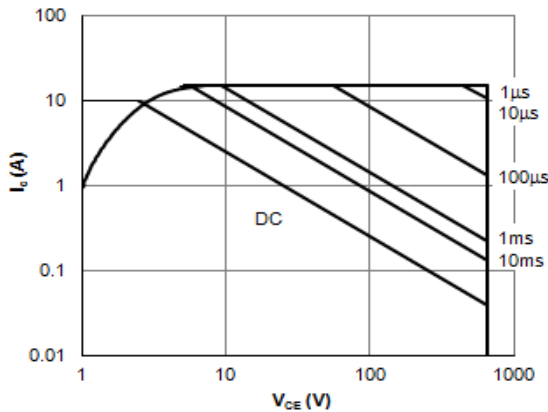

Figure 9: Forward Bias Safe Operating Area
($T_c=25^\circ\text{C}$, $V_{GE}=15\text{V}$)

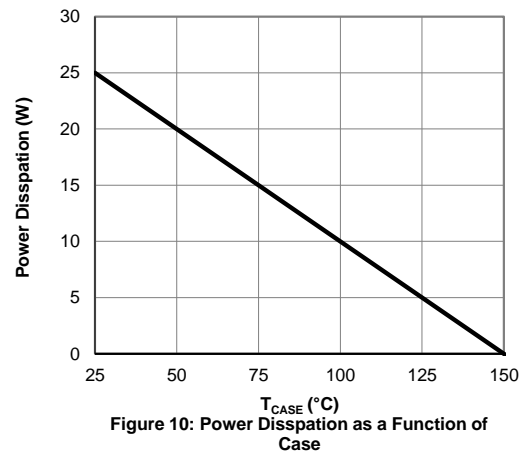

Figure 10: Power Dissipation as a Function of Case

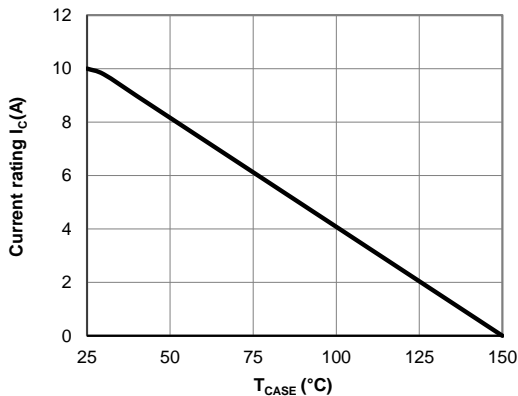

Figure 11: Current De-rating

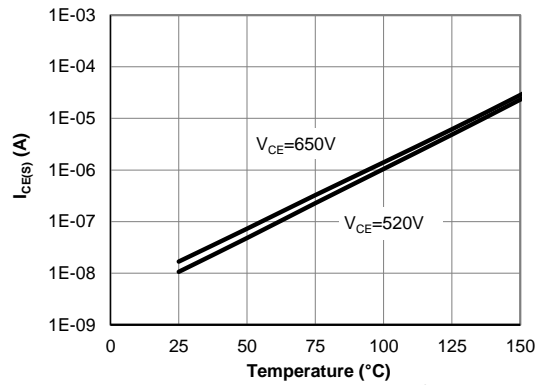

Figure 12: Diode Reverse Leakage Current vs. Junction Temperature

TYPICAL ELECTRICAL AND THERMAL CHARACTERISTICS

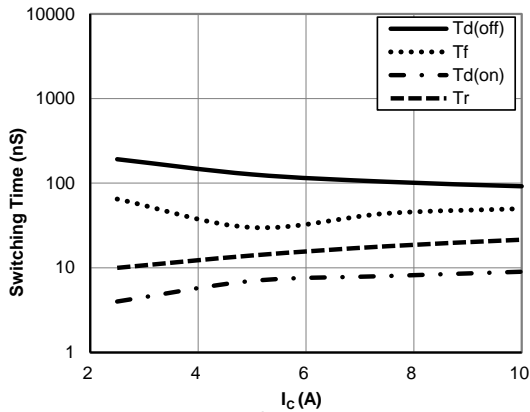

Figure 13: Switching Time vs. I_C
($T_J=150^\circ\text{C}$, $V_{GE}=15\text{V}$, $V_{CE}=400\text{V}$, $R_g=60\Omega$)

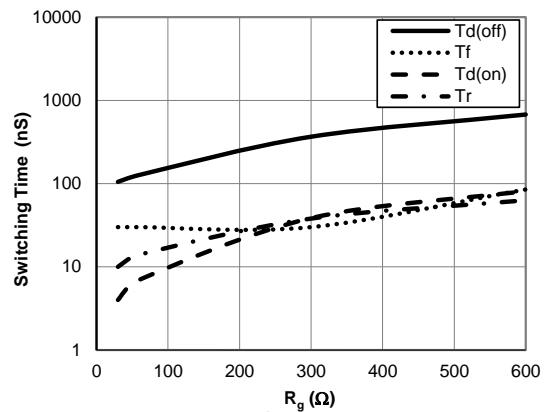

Figure 14: Switching Time vs. R_g
($T_J=150^\circ\text{C}$, $V_{GE}=15\text{V}$, $V_{CE}=400\text{V}$, $I_C=5\text{A}$)

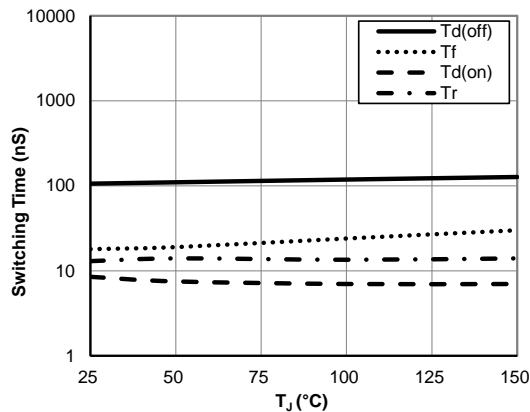

Figure 15: Switching Time vs. T_J
($V_{GE}=15\text{V}$, $V_{CE}=400\text{V}$, $I_C=5\text{A}$, $R_g=60\Omega$)

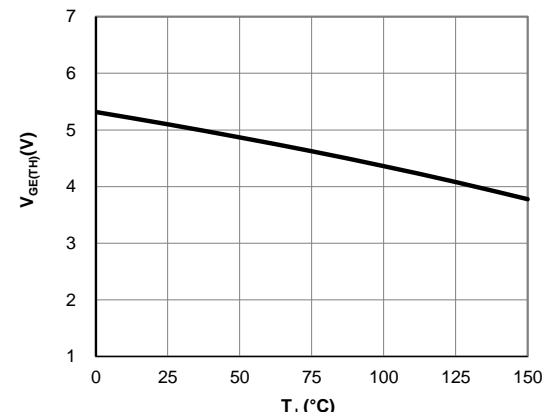

Figure 16: $V_{GE(TH)}$ vs. T_J

TYPICAL ELECTRICAL AND THERMAL CHARACTERISTICS

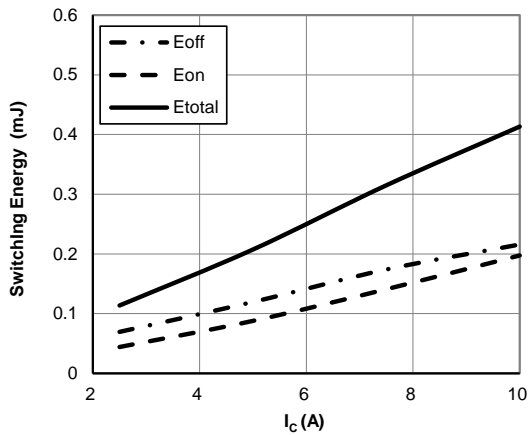

Figure 17: Switching Loss vs. I_C
($T_J=150^\circ\text{C}$, $V_{GE}=15\text{V}$, $V_{CE}=400\text{V}$, $R_g=60\Omega$)

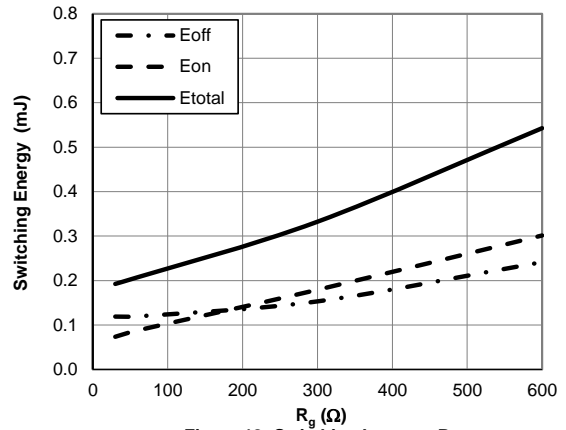

Figure 18: Switching Loss vs. R_g
($T_J=150^\circ\text{C}$, $V_{GE}=15\text{V}$, $V_{CE}=400\text{V}$, $I_C=5\text{A}$)

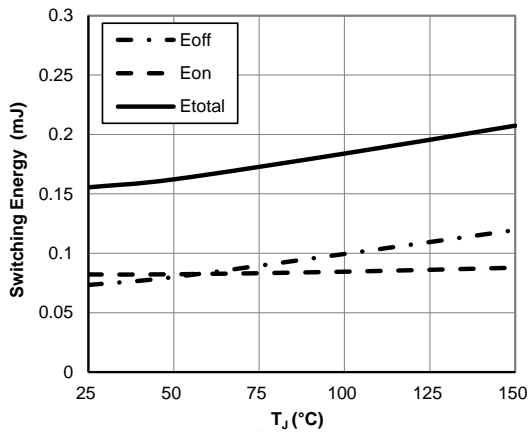

Figure 19: Switching Loss vs. T_J
($V_{GE}=15\text{V}$, $V_{CE}=400\text{V}$, $I_C=5\text{A}$, $R_g=60\Omega$)

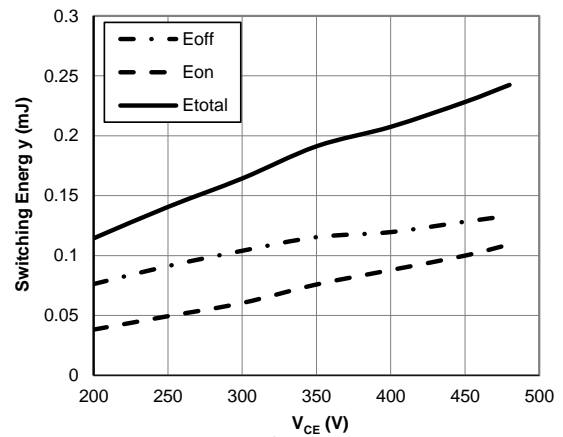

Figure 20: Switching Loss vs. V_{CE}
($T_J=150^\circ\text{C}$, $V_{GE}=15\text{V}$, $I_C=5\text{A}$, $R_g=60\Omega$)

TYPICAL ELECTRICAL AND THERMAL CHARACTERISTICS

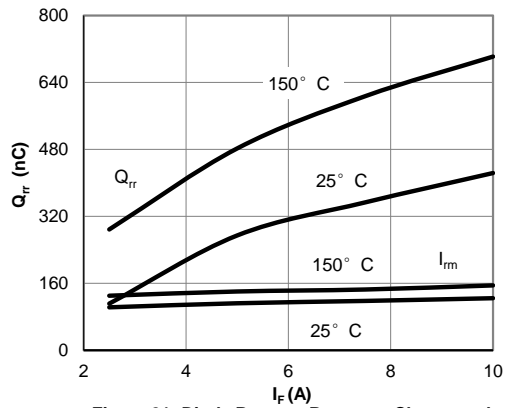

Figure 21: Diode Reverse Recovery Charge and Peak Current vs. Conduction Current
($V_{GE}=15V, V_{CE}=400V, di/dt=200A/\mu s$)

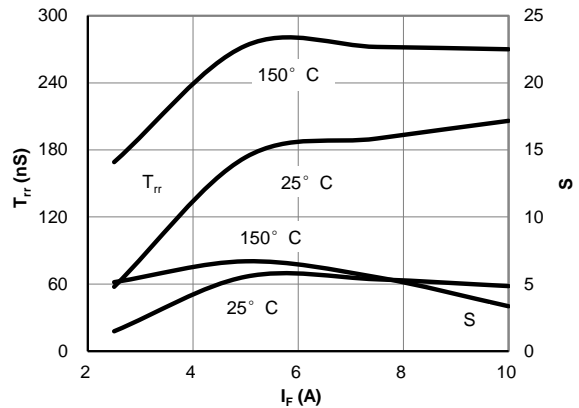

Figure 22: Diode Reverse Recovery Time and Softness Factor vs. Conduction Current
($V_{GE}=15V, V_{CE}=400V, di/dt=200A/\mu s$)

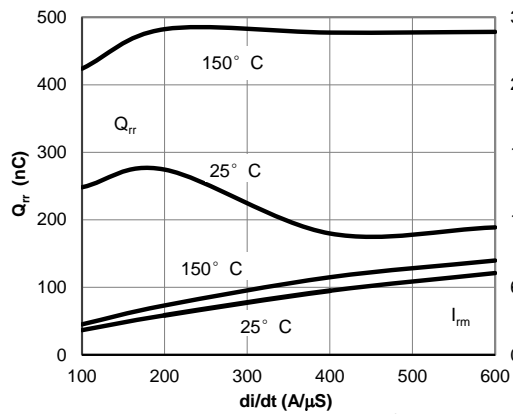

Figure 23: Diode Reverse Recovery Charge and Peak Current vs. di/dt
($V_{GE}=15V, V_{CE}=400V, I_F=5A$)

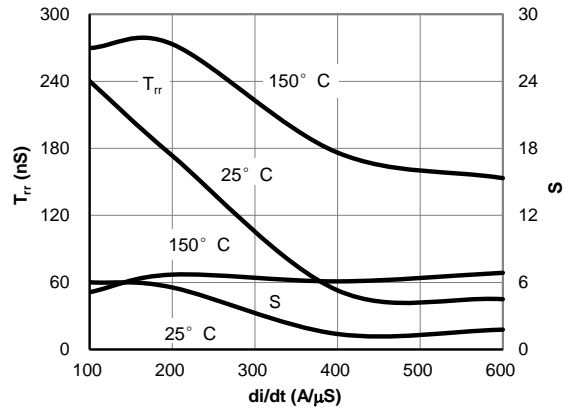

Figure 24: Diode Reverse Recovery Time and Softness Factor vs. di/dt
($V_{GE}=15V, V_{CE}=400V, I_F=5A$)

TYPICAL ELECTRICAL AND THERMAL CHARACTERISTICS

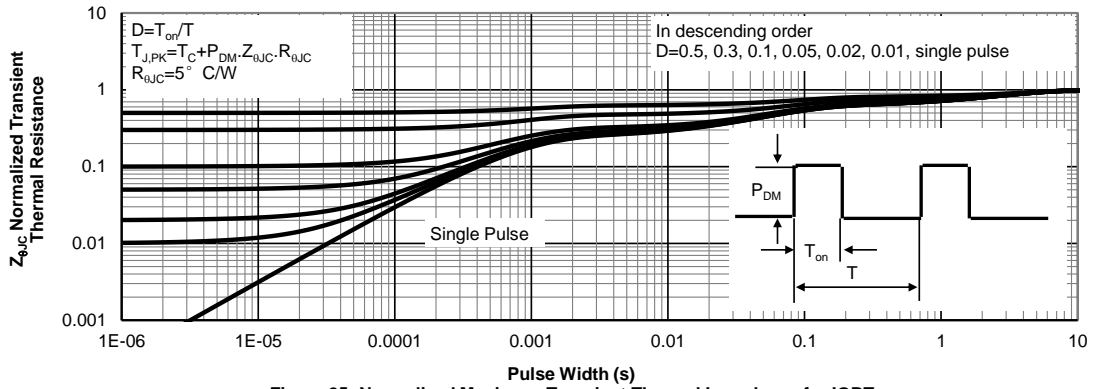

Figure 25: Normalized Maximum Transient Thermal Impedance for IGBT

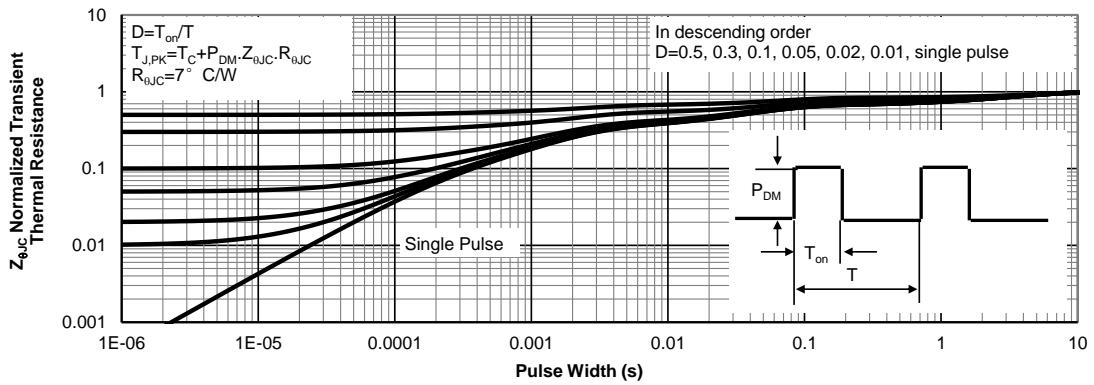

Figure 26: Normalized Maximum Transient Thermal Impedance for Diode

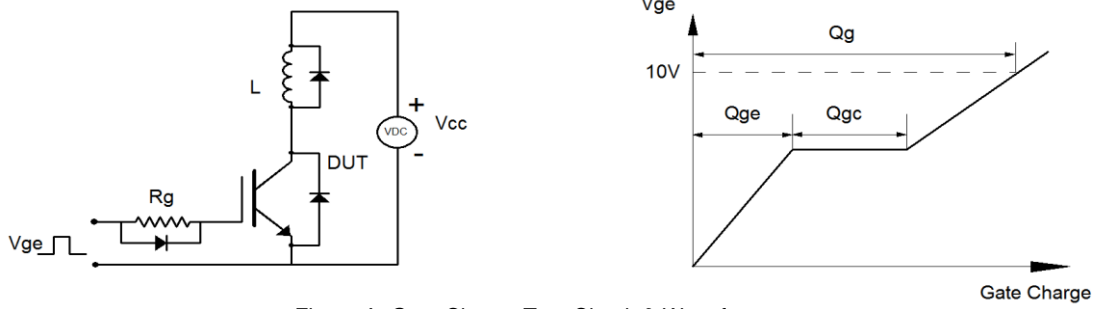

Figure A: Gate Charge Test Circuit & Waveforms

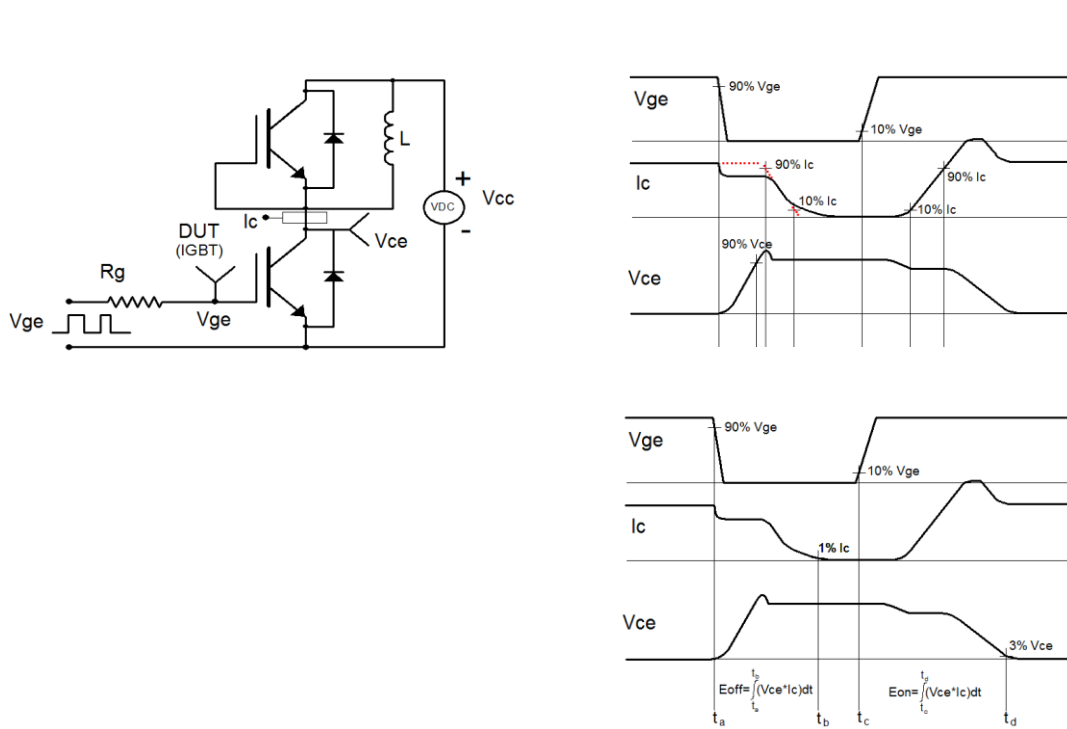

Figure B: Inductive Switching Test Circuit & Waveforms

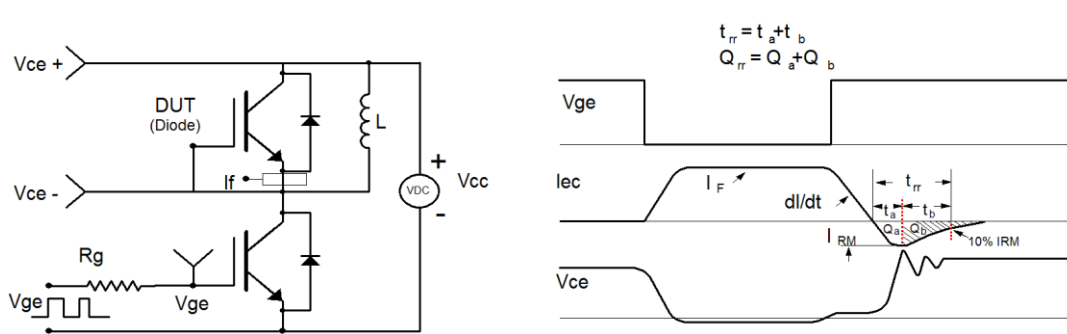

Figure C: Diode Recovery Test Circuit & Waveforms