

## Turbo 2 ultrafast - high voltage rectifier for flat panel displays

Datasheet - production data

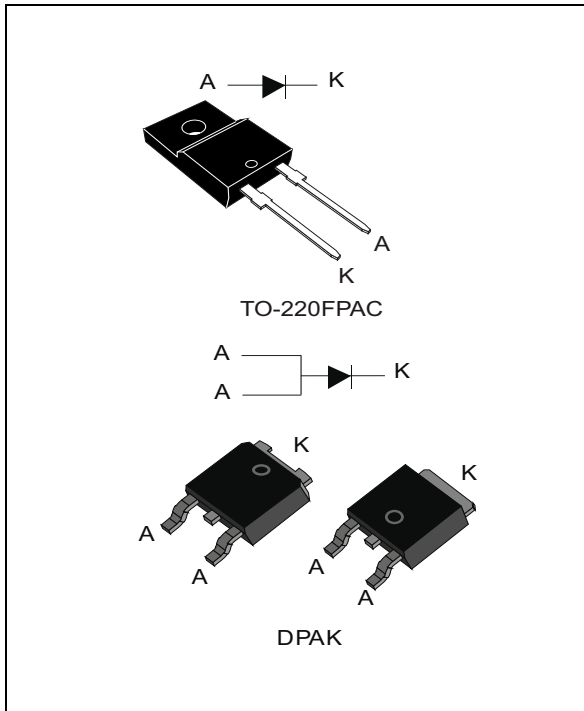

### Description

The STTH10LCD06 uses ST Turbo 2 technology. This device is suited for power applications in flat panel displays and especially applicable to switching power supplies in LCD.

Table 1. Device summary

Symbol	Value
$I_{F(AV)}$	10 A
$V_{RRM}$	600 V
$T_j(max)$	175 °C
$V_F$ (typ)	1.3 V
$t_{rr}$ (typ)	35 ns

### Features

- Ultrafast switching
- Low reverse current
- Low thermal resistance
- Reduce conduction and switching losses
- ECOPACK<sup>®</sup>2 compliant component for DPAK on demand
- Insulated package: TO-220FPAC
  - Insulated voltage: 2000  $V_{RMS}$  sine

# 1 Characteristics

**Table 2. Absolute ratings (limiting values at 25 °C, unless otherwise stated)**

Symbol	Parameter		Value	Unit
V <sub>RRM</sub>	Repetitive peak reverse voltage		600	V
I <sub>F(RMS)</sub>	RMS forward current	DPAK	18	A
		TO-220FPAC	35	
I <sub>F(AV)</sub>	Average forward current, δ = 0.5, square wave	DPAK	10	A
		TO-220FPAC		
			T <sub>c</sub> = 105° C	
			T <sub>c</sub> = 55° C	
I <sub>FSM</sub>	Surge non repetitive forward current	t <sub>p</sub> = 10 ms Sinusoidal	100	A
T <sub>stg</sub>	Storage temperature range		-65 to + 175	°C
T <sub>j</sub>	Maximum operating junction temperature <sup>(1)</sup>		175	°C

1.  $\frac{dP_{tot}}{dT_j} < \frac{1}{R_{th(j-a)}}$  condition to avoid thermal runaway for a diode on its own heatsink

**Table 3. Thermal resistance**

Symbol	Parameter		Value	Unit
R <sub>th(j-c)</sub>	Junction to case	DPAK	3.5	°C/W
		TO-220FPAC	6	

**Table 4. Static electrical characteristics**

Symbol	Parameter	Test conditions		Min.	Typ.	Max.	Unit
I <sub>R</sub> <sup>(1)</sup>	Reverse leakage current	T <sub>j</sub> = 25° C	V <sub>R</sub> = V <sub>RRM</sub>			5	µA
		T <sub>j</sub> = 150° C			13	130	
V <sub>F</sub> <sup>(2)</sup>	Forward voltage drop	T <sub>j</sub> = 25° C	I <sub>F</sub> = 10 A			2	V
		T <sub>j</sub> = 150° C			1.3	1.6	

1. Pulse test: t<sub>p</sub> = 5 ms, δ < 2%  
 2. Pulse test: t<sub>p</sub> = 380 µs, δ < 2%

To evaluate the conduction losses use the following equation:

$$P = 1.20 \times I_{F(AV)} + 0.040 I_{F(RMS)}^2$$

Table 5. Dynamic characteristics

Symbol	Parameter	Test conditions	Min.	Typ.	Max.	Unit
$t_{rr}$	Reverse recovery time	$I_F = 1 \text{ A}$ , $di_F/dt = -50 \text{ A}/\mu\text{s}$ , $V_R = 30 \text{ V}$ , $T_j = 25 \text{ }^\circ\text{C}$		35	50	ns
$I_{RM}$	Reverse recovery current	$I_F = 10 \text{ A}$ , $di_F/dt = -50 \text{ A}/\mu\text{s}$ , $V_R = 400 \text{ V}$ , $T_j = 125 \text{ }^\circ\text{C}$		2.0	2.8	A
$t_{fr}$	Forward recovery time	$I_F = 10 \text{ A}$ $di_F/dt = 100 \text{ A}/\mu\text{s}$ $V_{FR} = 1.1 \times V_{Fmax}$ , $T_j = 25 \text{ }^\circ\text{C}$			230	ns
$V_{FP}$	Forward recovery voltage	$I_F = 10 \text{ A}$ , $di_F/dt = 100 \text{ A}/\mu\text{s}$ , $V_{FR} = 1.1 \times V_{Fmax}$ , $T_j = 25 \text{ }^\circ\text{C}$		4		V

Figure 1. Conduction losses versus average current

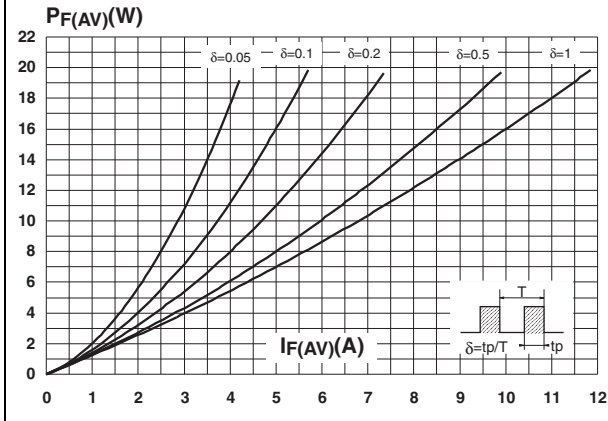

Figure 2. Forward voltage drop versus forward current

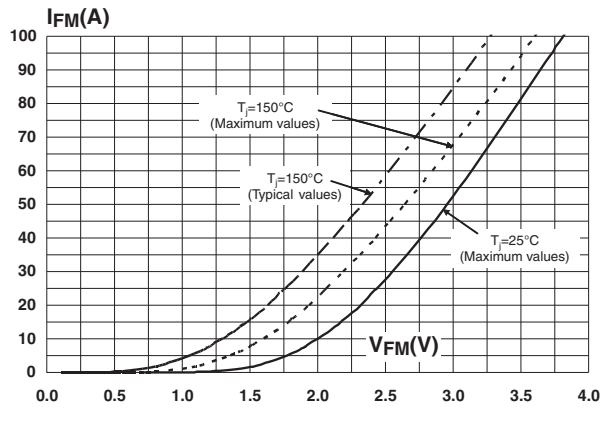

Figure 3. Relative variation of thermal impedance junction to case versus pulse duration (DPAK)

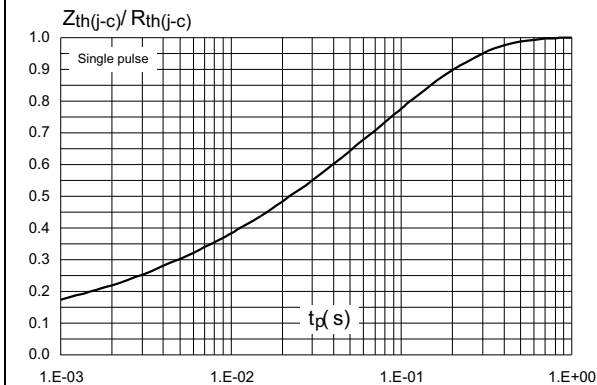

Figure 4. Relative variation of thermal impedance junction to case versus pulse duration (TO-220FPAC)

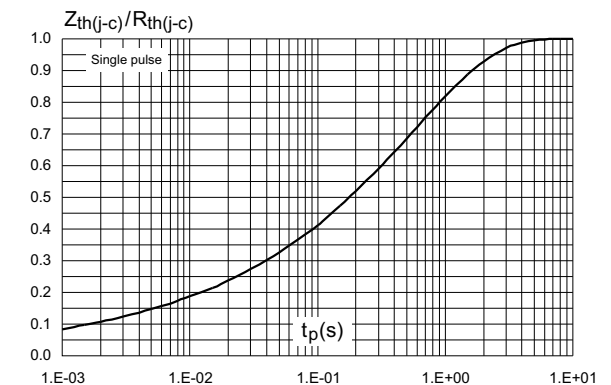

Figure 5. Peak reverse recovery current versus  $di_F/dt$  (typical values)

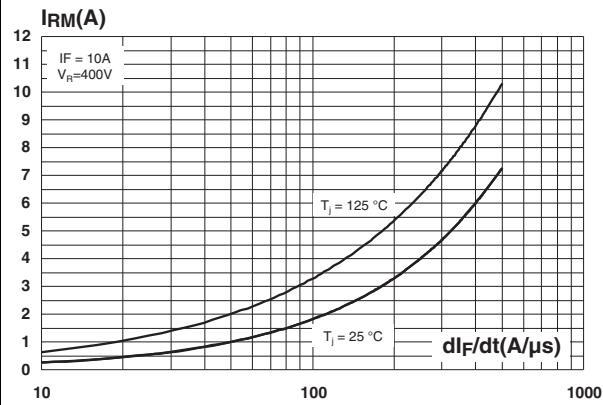

Figure 6. Reverse recovery time versus  $di_F/dt$  (typical values)

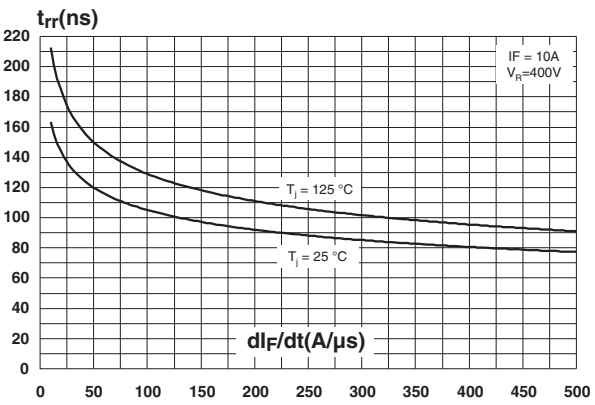

Figure 7. Reverse recovery charges versus  $di_F/dt$  (typical values)

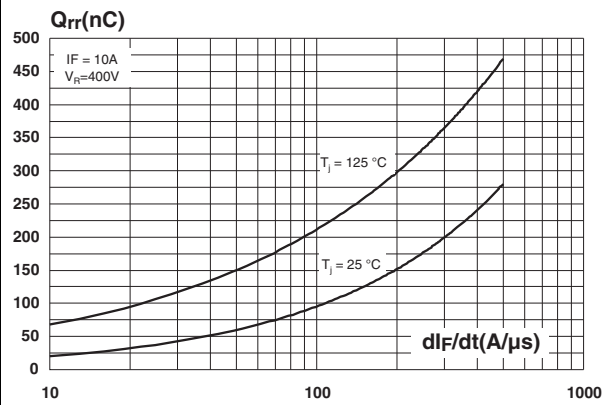

Figure 8. Relative variations of dynamic parameters versus junction temperature

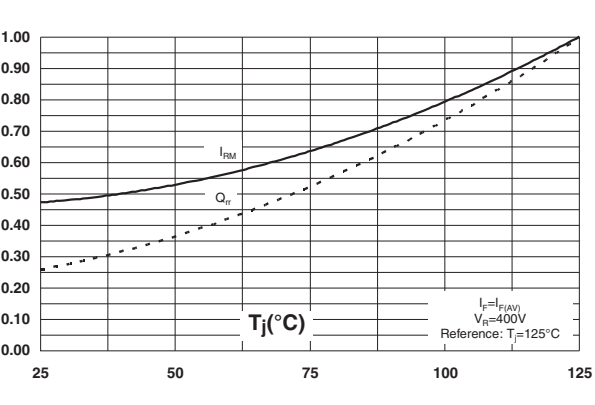

Figure 9. Transient peak forward voltage versus  $di_F/dt$  (typical values)

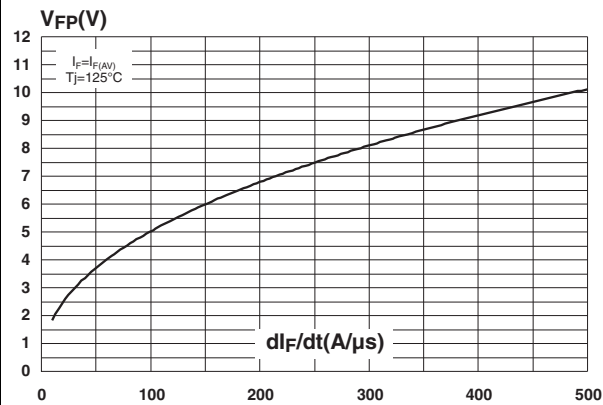

Figure 10. Forward recovery time versus  $di_F/dt$  (typical values)

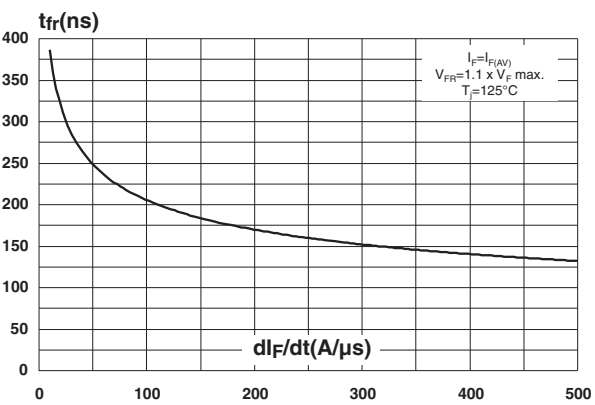
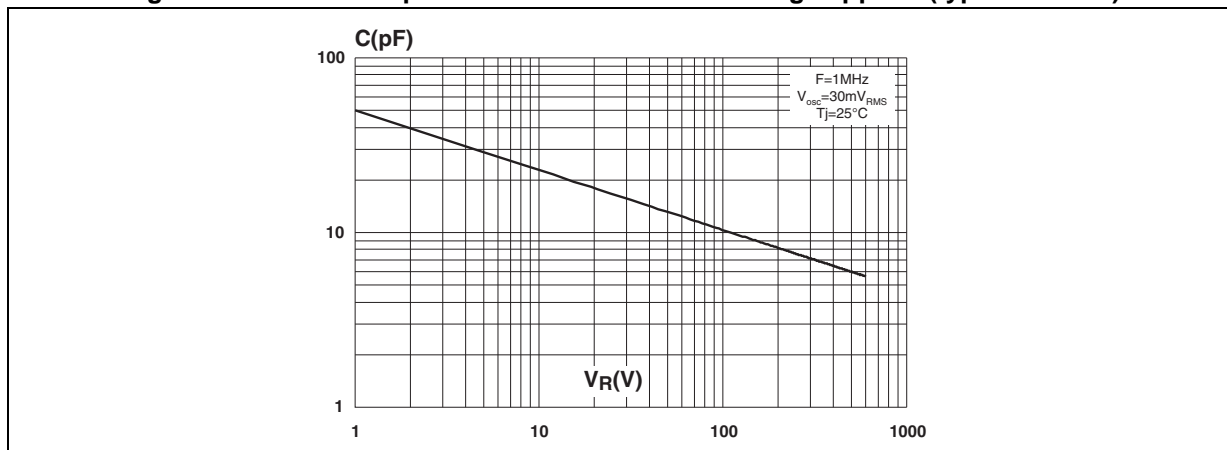

Figure 11. Junction capacitance versus reverse voltage applied (typical values)



## 2 Package information

- Epoxy meets UL94, V0
- Cooling method: by conduction (C)
- Recommended torque values: 0.55 N·m for TO-220FPAC
- Maximum torque value: 0.7 N·m for TO-220FPAC

In order to meet environmental requirements, ST offers these devices in different grades of ECOPACK<sup>®</sup> packages, depending on their level of environmental compliance. ECOPACK<sup>®</sup> specifications, grade definitions and product status are available at: [www.st.com](http://www.st.com). ECOPACK<sup>®</sup> is an ST trademark.

### 2.1 TO-220FPAC package information

Figure 12. TO-220FPAC package outline

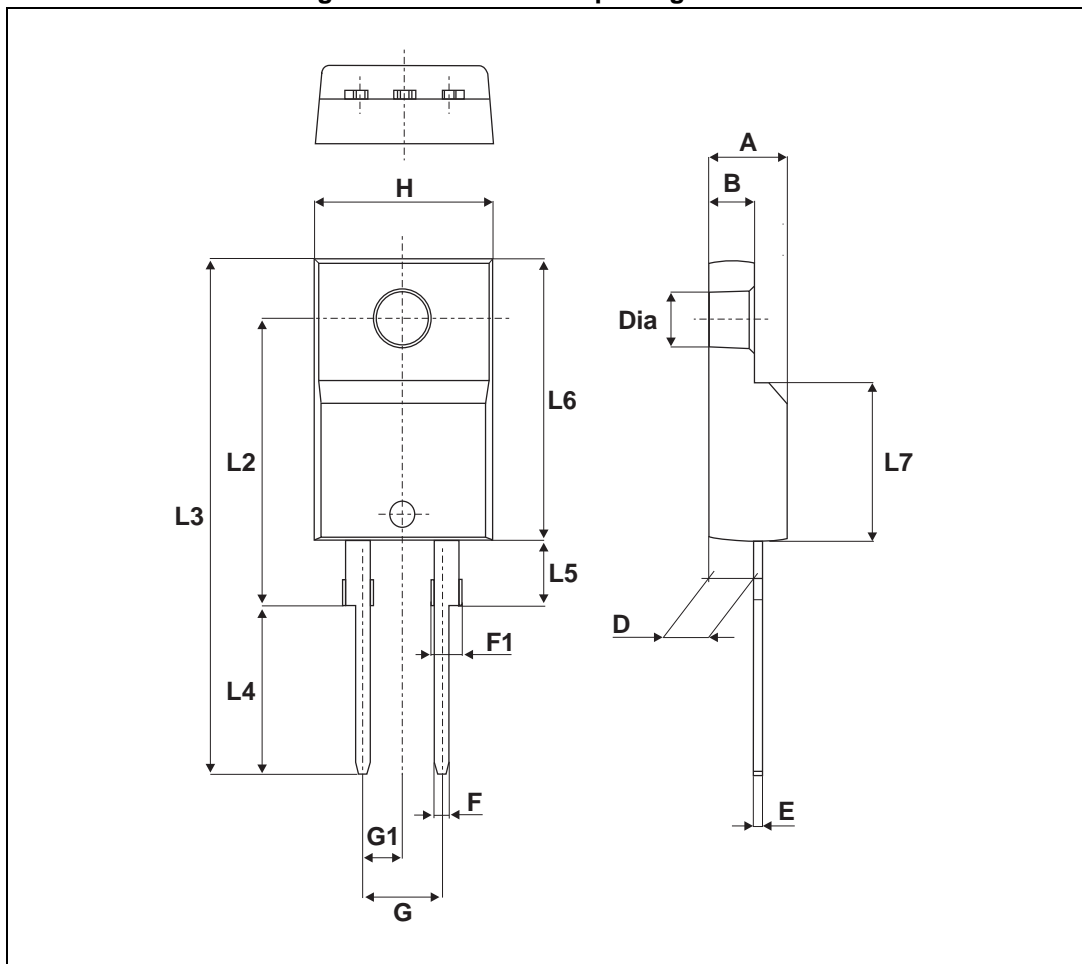
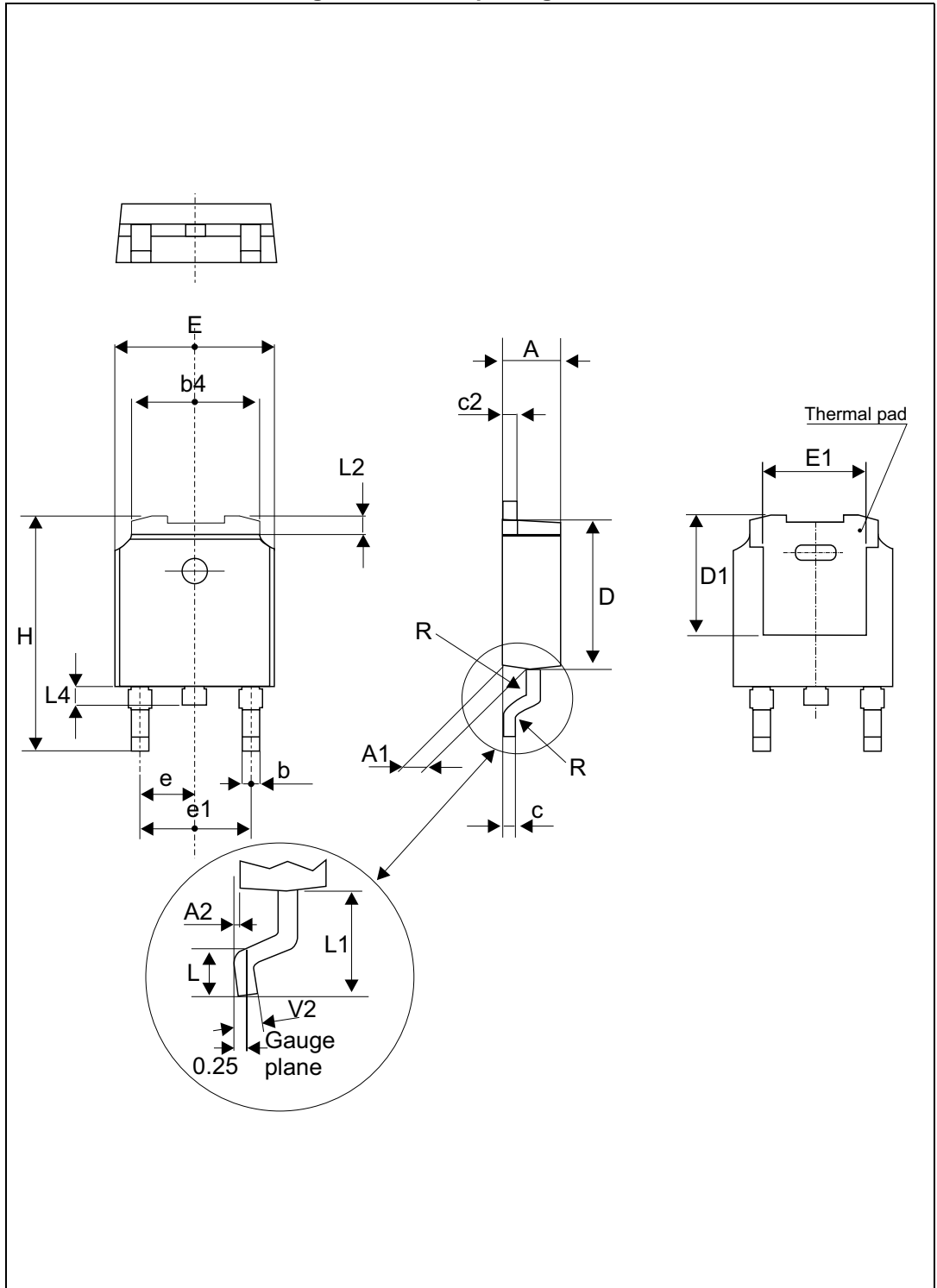

Table 6. TO-220FPAC package mechanical data

Ref.	Dimensions					
	Millimeters			Inches		
	Min.	Typ.	Max.	Min.	Typ.	Max.
A	4.40		4.60	0.173		0.181
B	2.50		2.70	0.098		0.106
D	2.50		2.75	0.098		0.108
E	0.45		0.70	0.018		0.027
F	0.75		1.00	0.030		0.039
F1	1.15		1.70	0.045		0.067
G	4.95		5.20	0.195		0.205
G1	2.40		2.70	0.094		0.106
H	10.00		10.40	0.393		0.409
L2		16.00 Typ.			0.630 Typ.	
L3	28.60		30.60	1.126		1.205
L4	9.80		10.60	0.386		0.417
L6	15.90		16.40	0.626		0.646
L7	9.00		9.30	0.354		0.366
Dia.	3.00		3.20	0.118		0.126

## 2.2 DPAK package information

Figure 13. DPAK package outline



Note: This package drawing may slightly differ from the physical package. However, all the specified dimensions are guaranteed.



Table 7. DPAK package mechanical data

Ref.	Dimensions					
	Millimeters			Inches		
	Min.	Typ.	Max.	Min.	Typ.	Max.
A	2.18		2.40	0.085		0.094
A1	0.90		1.10	0.035		0.043
A2	0.03		0.23	0.001		0.009
b	0.64		0.90	0.025		0.035
b4	4.95		5.46	0.194		0.214
c	0.46		0.61	0.018		0.024
c2	0.46		0.60	0.018		0.023
D	5.97		6.22	0.235		0.244
D1	4.95			0.194		
E	6.35		6.73	0.250		0.264
E1	4.32			0.170		
e		2.28			0.090	
e1	4.40		4.70	0.173		0.185
H	9.35		10.40	0.368		0.409
L	1.00		1.78	0.039		0.070
L2			1.27			0.050
L4	0.60		1.02	0.023		0.040
V2	-8°		+8°	-8°		8°

Figure 14. Footprint (dimensions in mm)

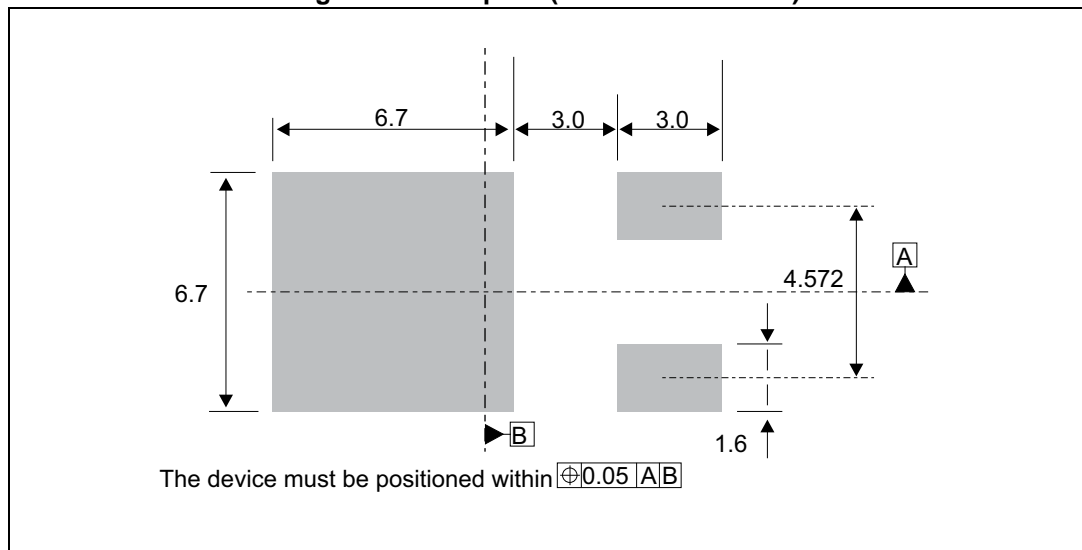

### 3 Ordering information

**Table 8. Ordering information**

Order code	Marking	Package	Weight	Base qty	Delivery mode
STTH10LCD06FP	STTH10LCD06FP	TO-220FPAC	1.9 g	50	Tube
STTH10LCD06SB-TR	TH10LCD06S	DKPAK	1.8 g	2500	Tape and reel

### 4 Revision history

**Table 9. Document revision history**

Date	Revision	Changes
14-May-2008	1	First issue.
23-Oct-2008	2	Updated DKPAK package information and reformatted to current standard.
13-Nov-2015	3	Removed TO-220FPAC and D <sup>2</sup> PAK package information. Updated DKPAK package information and reformatted to current standard.

**IMPORTANT NOTICE – PLEASE READ CAREFULLY**

STMicroelectronics NV and its subsidiaries ("ST") reserve the right to make changes, corrections, enhancements, modifications, and improvements to ST products and/or to this document at any time without notice. Purchasers should obtain the latest relevant information on ST products before placing orders. ST products are sold pursuant to ST's terms and conditions of sale in place at the time of order acknowledgement.

Purchasers are solely responsible for the choice, selection, and use of ST products and ST assumes no liability for application assistance or the design of Purchasers' products.

No license, express or implied, to any intellectual property right is granted by ST herein.

Resale of ST products with provisions different from the information set forth herein shall void any warranty granted by ST for such product.

ST and the ST logo are trademarks of ST. All other product or service names are the property of their respective owners.

Information in this document supersedes and replaces information previously supplied in any prior versions of this document.

© 2015 STMicroelectronics – All rights reserved

