

FEATURES

- 600 kHz PWM Frequency
- Fully Integrated 1.5 A Power Switch
- 3% Output Regulation Accuracy
- Simple Compensation
- Small Inductor and MLC Capacitors
- 300 μ A Quiescent Supply Current
- 90% Efficiency
- Undervoltage Lockout
- 5 Buffers
- TSSOP 20-Lead Package
- Pb-Free Part

APPLICATIONS

- TFT LCD Bias Supplies

GENERAL DESCRIPTION

The ADP3041 is a fixed frequency, PWM step-up dc-to-dc switching regulator with five buffers capable of 12 V boosted output voltage in a TSSOP 20-lead package. It provides high efficiency, low noise operation, and excellent dynamic response, and is easy to use. The high switching frequency allows for small, cost-saving, external inductive and capacitive components. The ADP3041 operates in PWM current mode. The current limit and the power switch are integrated completely on-chip.

Capable of operating from 2.5 V to 5.5 V input, the ADP3041 is ideal for thin-film transistor (TFT) liquid crystal display (LCD) module applications, where local point-of-use power regulation is required. Supporting output voltages down to 4.5 V, the ADP3041 is ideal to generate today's low voltage rails, providing the optimal solution in its class for delivering power efficiently, responsively, and simply with minimal printed circuit board area.

The ADP3041 integrates five buffers. Each buffer can deliver 35 mA output current and has rail-to-rail input and output capability.

FUNCTIONAL BLOCK DIAGRAM

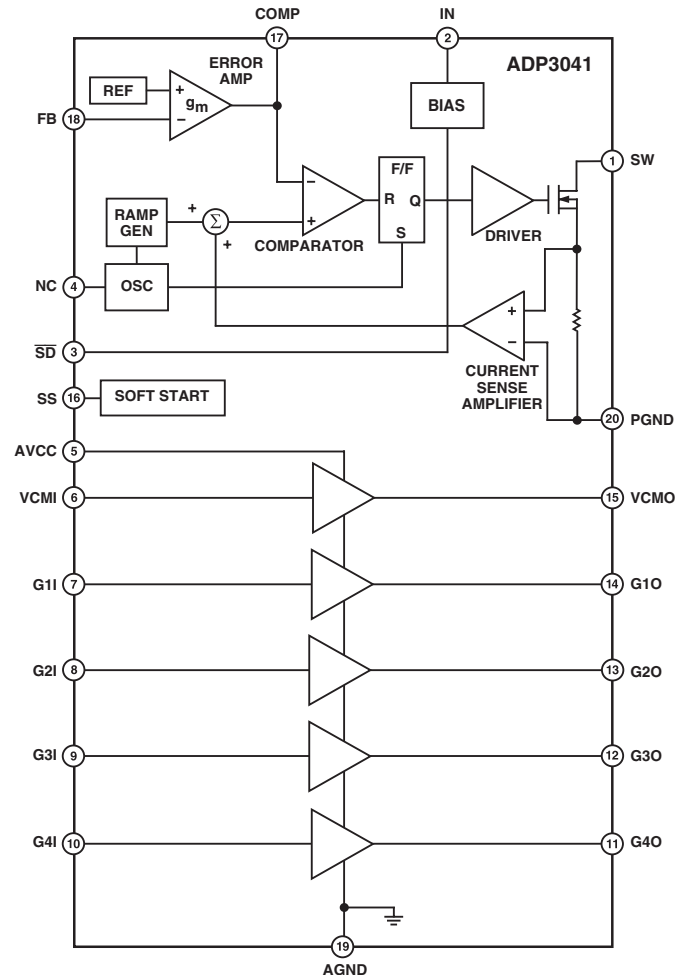

REV. D

Information furnished by Analog Devices is believed to be accurate and reliable. However, no responsibility is assumed by Analog Devices for its use, nor for any infringements of patents or other rights of third parties that may result from its use. No license is granted by implication or otherwise under any patent or patent rights of Analog Devices. Trademarks and registered trademarks are the property of their respective owners.

ADP3041—SPECIFICATIONS¹ ($V_{IN} = 3.3\text{ V}$, $T_A = -40^\circ\text{C}$ to $+85^\circ\text{C}$, unless otherwise noted.)

Parameter	Symbol	Conditions	Min	Typ	Max	Unit
SUPPLY						
Input Voltage	V_{IN}		2.5	3.3	5.5	V
Operating Current ²	I_{QSW}	$f = 600\text{ kHz}$, No Load, AVCC = Open		1	5	mA
Quiescent Current	I_Q	Not Switching, AVCC = Open		270	500	μA
Shutdown Current	I_{SD}	AVCC = Open			10	μA
ERROR AMPLIFIER						
Feedback Voltage Accuracy	V_{FB}	$V_{IN} = 2.5\text{ V}$ to 5.5 V	1.215	1.233	1.251	V
Line Regulation			-0.15		+0.15	%/V
FB Bias Current					100	nA
Overall Regulation		Line, Temperature	-3		+3	%
OUTPUT SWITCH						
On Resistance	$R_{DS(ON)}$	At 1.5 A, $V_{IN} = 3.3\text{ V}$			300	m Ω
Output Load Current	I_{LOAD}	Continuous Operation, $V_{IN} = 3.3\text{ V}$, $V_{OUT} = 10\text{ V}$		300		mA
Leakage Current		$V_{SWITCH} = 12\text{ V}$, $\overline{SD} = 0\text{ V}$			5	μA
Efficiency		$I_{LOAD} = 200\text{ mA}$, $V_{OUT} = 10\text{ V}$ $I_{LOAD} = 100\text{ mA}$, $V_{OUT} = 10\text{ V}$		90		%
				90		%
OSCILLATOR						
Oscillator Frequency	f_{OSC}		0.4	0.6	0.9	MHz
Maximum Duty Cycle	D_{MAX}	COMP = Open, FB = 1 V		80	90	%
Minimum Duty Cycle	D_{MIN}	COMP = Open, FB = 1 V			40	%
SOFT START						
Charge Current		$V_{SS} = 3.3\text{ V}$, $C_{SS} = 1\text{ nF}$		2.5		μA
SHUTDOWN						
Input Voltage Low					0.8	V
Input Voltage High			2.2			V
CURRENT LIMIT						
Peak Switch Current	I_{CL}		1.5	1.8		A
COMPENSATION						
Transconductance	g_m			100		$\mu\text{A/V}$
Gain	A_V			1000		V/V
UNDERVOLTAGE LOCKOUT						
UVLO Threshold			2.2	2.4	2.5	V
UVLO Hysteresis				130		mV
OUTPUT						
Voltage Range	V_{OUT}	$V_{IN} = 2.5\text{ V}$ to 5.5 V	4.5		12	V
Load Regulation		$I_{LOAD} = 10\text{ mA}$ to 150 mA , $V_{OUT} = 10\text{ V}$		0.05		mV/mA

Parameter	Symbol	Conditions	Min	Typ	Max	Unit
BUFFER INPUT CHARACTERISTICS						
Offset Voltage	V_{OS}			2	10	mV
Offset Voltage Drift	$\Delta V_{OS}/\Delta T$	$-40^{\circ}\text{C} \leq T_A \leq +85^{\circ}\text{C}$		5		$\mu\text{V}/^{\circ}\text{C}$
Input Bias Current	I_B	$-40^{\circ}\text{C} \leq T_A \leq +85^{\circ}\text{C}$		80	600	nA
Input Voltage Range			-0.5		$V_S + 0.5$	V
Input Impedance	Z_{IN}			400		k Ω
Input Capacitance	C_{IN}			1		pF
OUTPUT CHARACTERISTICS						
Output Voltage High	V_{OH}	$I_L = 100 \mu\text{A}$ $V_S = 12 \text{ V}, I_L = 5 \text{ mA}$ $-40^{\circ}\text{C} \leq T_A \leq +85^{\circ}\text{C}$	11.85 11.75	$V_S - 0.005$ 11.94		V V V
Output Voltage Low	V_{OL}	$I_L = 100 \mu\text{A}$ $V_S = 12 \text{ V}, I_L = 5 \text{ mA}$ $-40^{\circ}\text{C} \leq T_A \leq +85^{\circ}\text{C}$	4.2 4.1	4.38		V V
Continuous Output Current	I_{OUT}			5		mV
Peak Output Current	I_{PK}	$V_S = 12 \text{ V}$		42	150	mV mV
				95	300	mV mV
				35	400	mV mA
TRANSFER CHARACTERISTICS						
Gain	AVCL	$R_L = 2 \text{ k}\Omega$ $-40^{\circ}\text{C} \leq T_A \leq +85^{\circ}\text{C}$	0.995 0.995	0.9985 0.9985	1.005 1.005	V/V V/V
Gain Linearity	NL	$R_L = 2 \text{ k}\Omega$, $V_O = 0.5 \text{ to } (V_S - 0.5 \text{ V})$		0.01		%
POWER SUPPLY						
Supply Voltage	V_S		4.5		12	V
Power Supply Rejection Ratio	PSRR	$V_S = 4 \text{ V to } 12 \text{ V}$, $-40^{\circ}\text{C} \leq T_A \leq +85^{\circ}\text{C}$	70	90		dB
Supply Current/Amplifier	I_{SY}	$V_O = V_S/2$, No Load $-40^{\circ}\text{C} \leq T_A \leq +85^{\circ}\text{C}$		780	1000	μA mA
DYNAMIC PERFORMANCE						
Slew Rate	SR	$R_L = 10 \text{ k}\Omega$, $C_L = 200 \text{ pF}$	4.5	8		V/ μs
Bandwidth	BW	-3 dB, $R_L = 10 \text{ k}\Omega$, $C_L = 10 \text{ pF}$		8		MHz
Phase Margin	ϕ_m	$R_L = 10 \text{ k}\Omega$, $C_L = 10 \text{ pF}$		65		Degrees
NOISE PERFORMANCE						
Voltage Noise Density	e_n	$f = 1 \text{ kHz}$		27		$\text{nV}/\sqrt{\text{Hz}}$
	e_n	$f = 10 \text{ kHz}$		25		$\text{nV}/\sqrt{\text{Hz}}$
Current Noise Density	i_n	$f = 10 \text{ kHz}$		0.8		$\text{pA}/\sqrt{\text{Hz}}$

NOTES

¹All limits at temperature extremes are guaranteed via correlation and characterization using standard Statistical Quality Control (SQC).

²This is the average current while switching.

Specifications subject to change without notice.

ADP3041

ABSOLUTE MAXIMUM RATINGS*

Input Voltage	-0.3 V to + 6 V
Buffer Input Voltage	-0.5 V to AVCC + 0.5 V
SW Voltage	14 V
COMP Voltage	-0.3 V to +2.5 V
FB Voltage	-0.3 V to +1.3 V
SD Voltage	-0.3 V to +6 V
PGND to GND	±200 mV
Operating Ambient Temperature Range	-40°C to +85°C
Operating Junction Temperature Range	-40°C to +125°C
Storage Temperature Range	-65°C to +150°C
θ_{JA} 2-Layer	143°C/W
θ_{JA} 4-Layer	112°C/W
Lead Temperature Range (Soldering 60 sec)	300°C

*Stresses above those listed under Absolute Maximum Ratings may cause permanent damage to the device. This is a stress rating only; functional operation of the device at these or any other conditions above those listed in the operational sections of this specification is not implied. Exposure to absolute maximum ratings for extended periods may affect device reliability.

PIN CONFIGURATION

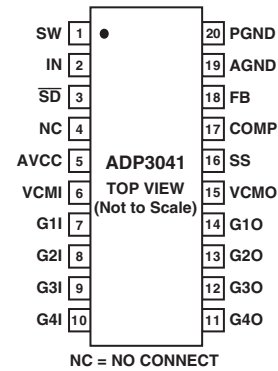

ORDERING GUIDE

Model	Temperature Range	Voltage Output	Package Option
ADP3041ARU	-40°C to +85°C	4.5 V to 12 V	TSSOP-20
ADP3041ARUZ*	-40°C to +85°C	4.5 V to 12 V	TSSOP-20

*Z = Pb-free part.

PIN FUNCTION DESCRIPTIONS

Pin No.	Mnemonic	Function
1	SW	Switching Output
2	IN	Main Power Supply Input
3	\overline{SD}	Shutdown Input
4	NC	No Connection
5	AVCC	Buffers Power Supply Input
6	VCM1	VCOM Buffer Input
7	G1I	Gamma 1 Buffer Input
8	G2I	Gamma 2 Buffer Input
9	G3I	Gamma 3 Buffer Input
10	G4I	Gamma 4 Buffer Input
11	G4O	Gamma 4 Buffer Output
12	G3O	Gamma 3 Buffer Output
13	G2O	Gamma 2 Buffer Output
14	G1O	Gamma 1 Buffer Output
15	VCMO	VCOM Buffer Output
16	SS	Soft Start Capacitor Timer Set
17	COMP	Compensation Input
18	FB	Feedback Voltage Sense Input
19	AGND	Analog Signal Ground
20	PGND	Ground Return for Power Transistor

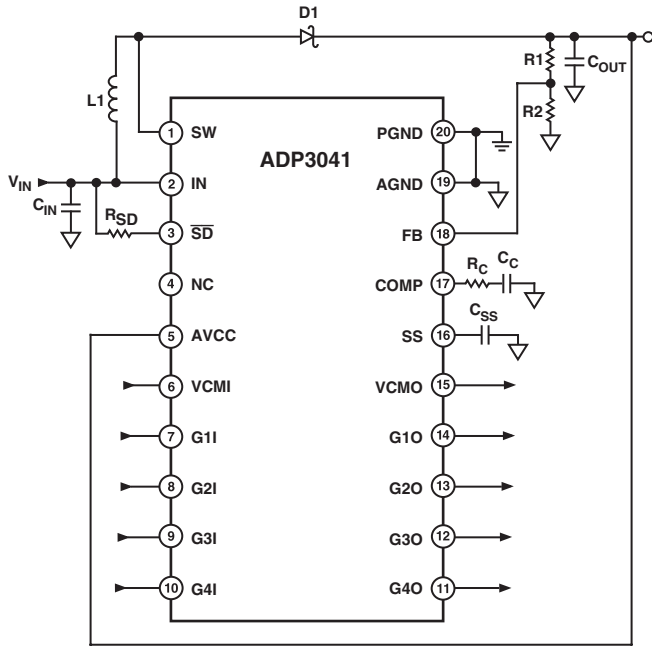

Figure 1. Typical Application

CAUTION

ESD (electrostatic discharge) sensitive device. Electrostatic charges as high as 4000 V readily accumulate on the human body and test equipment and can discharge without detection. Although the ADP3041 features proprietary ESD protection circuitry, permanent damage may occur on devices subjected to high energy electrostatic discharges. Therefore, proper ESD precautions are recommended to avoid performance degradation or loss of functionality.



Typical Performance Characteristics—ADP3041

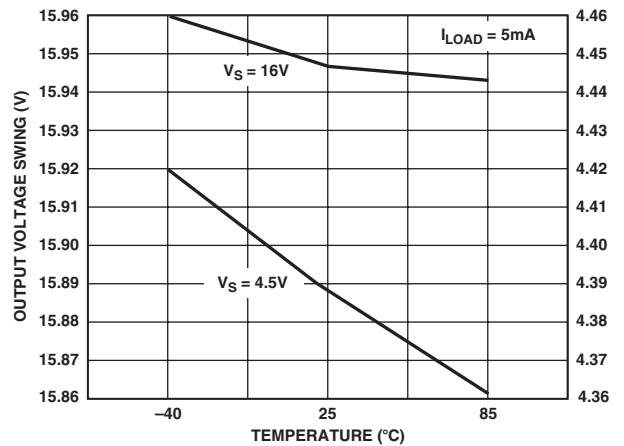
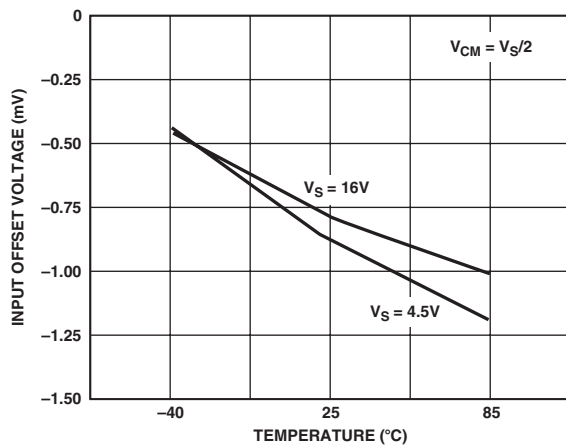
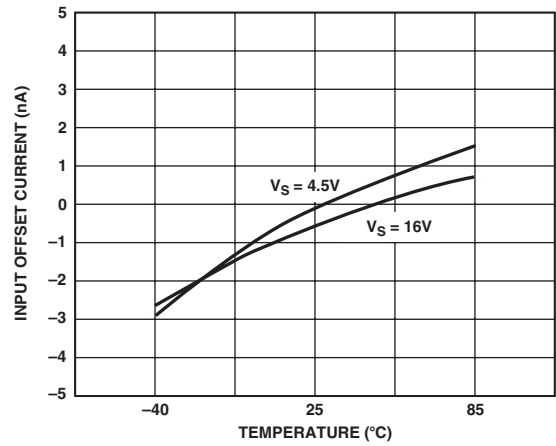
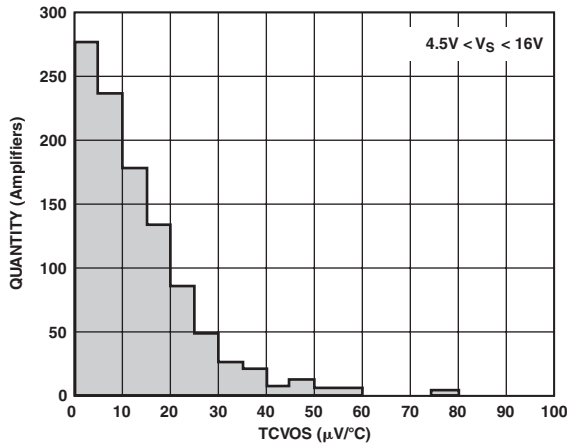
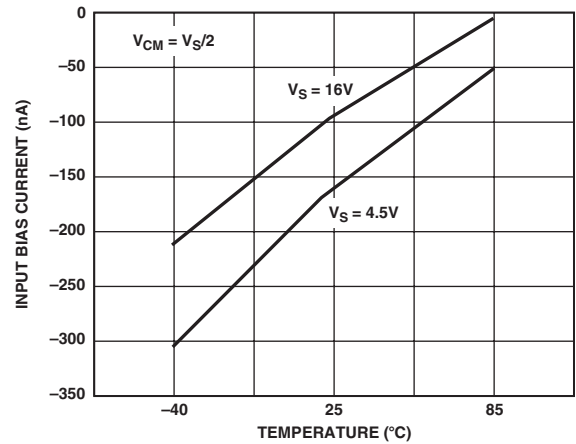
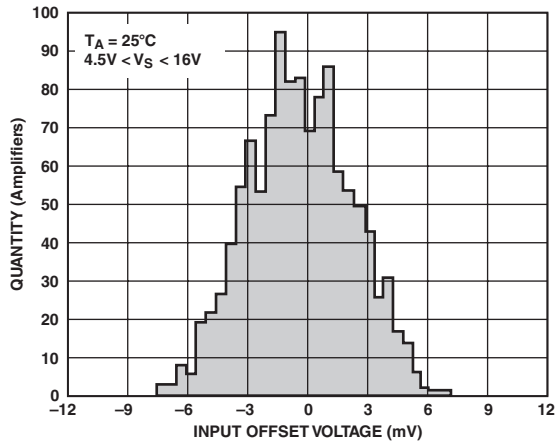

ADP3041

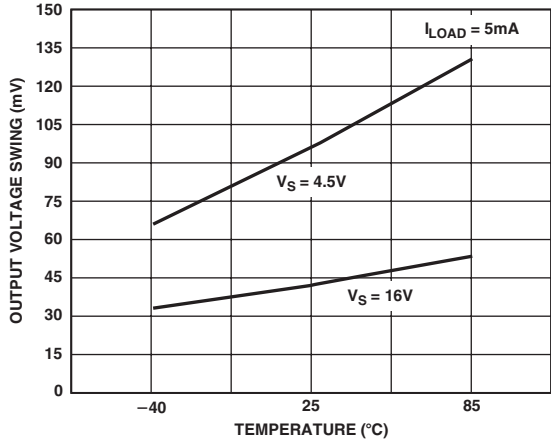

TPC 7. Output Voltage Swing vs. Temperature (Small Signal)

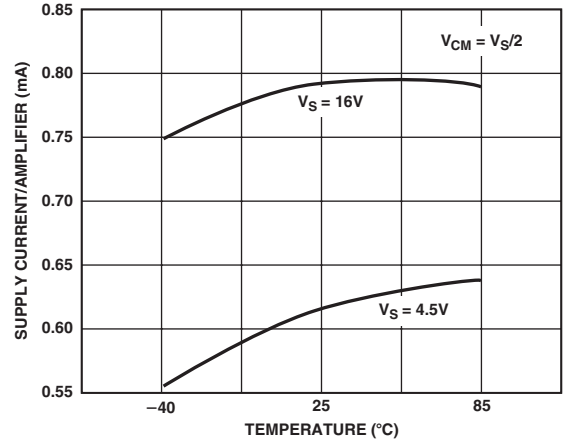

TPC 10. Supply Current/Amplifier vs. Temperature

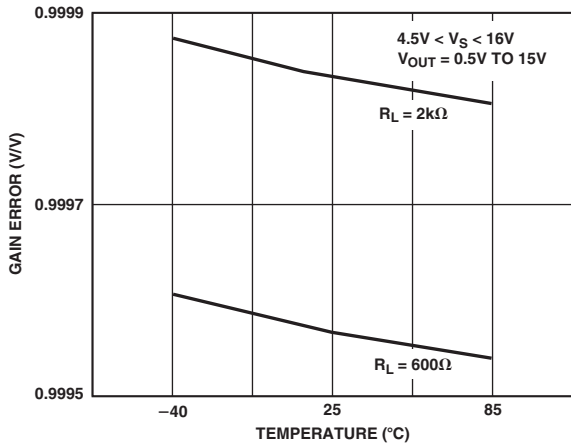

TPC 8. Voltage Gain vs. Temperature

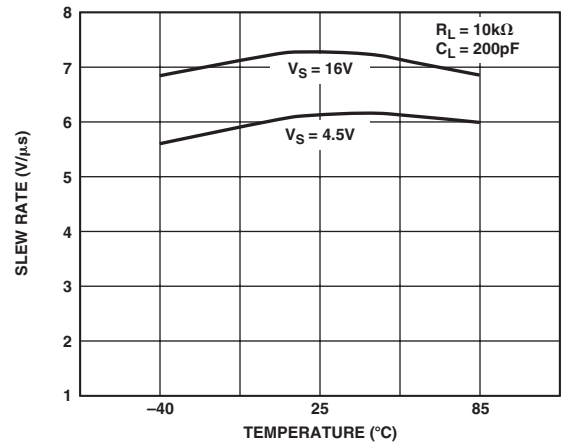

TPC 11. Slew Rate vs. Temperature

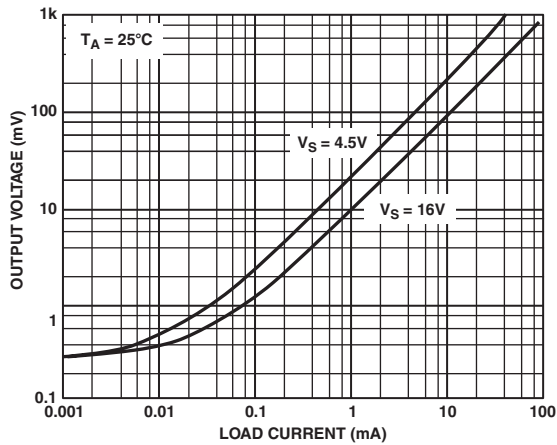

TPC 9. Output Voltage to Supply Rail vs. Load Current

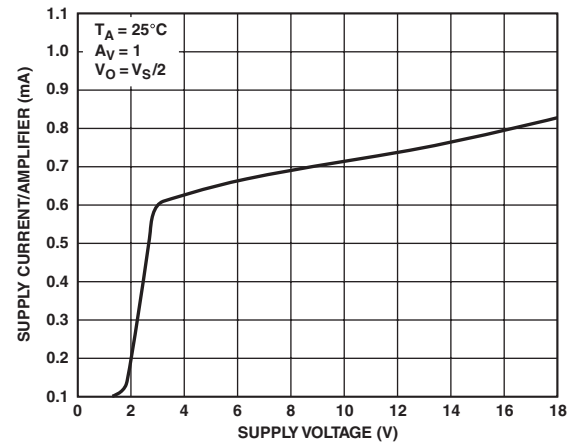

TPC 12. Supply Current/Amplifier vs. Supply Voltage

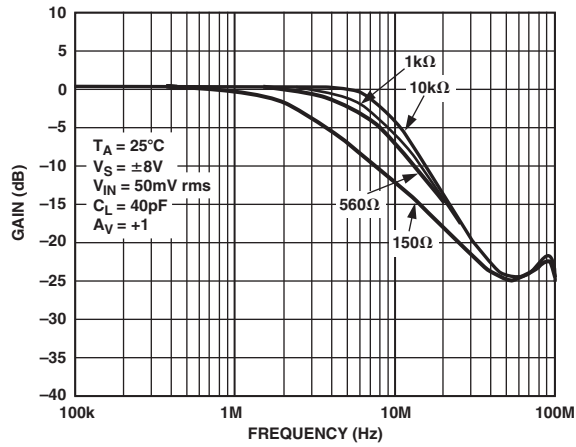

TPC 13. Resistive Loading vs. Frequency Response

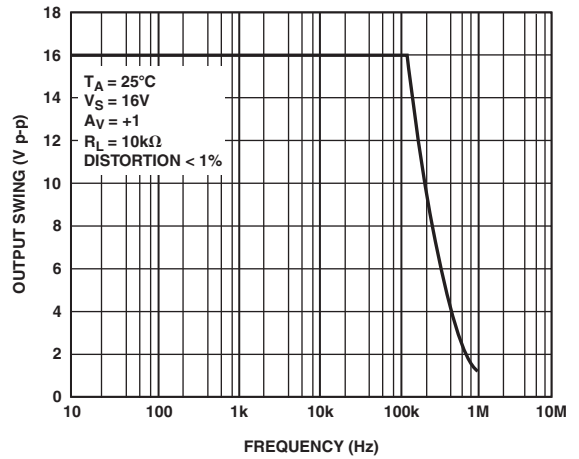

TPC 16. Closed-Loop Output Swing vs. Frequency

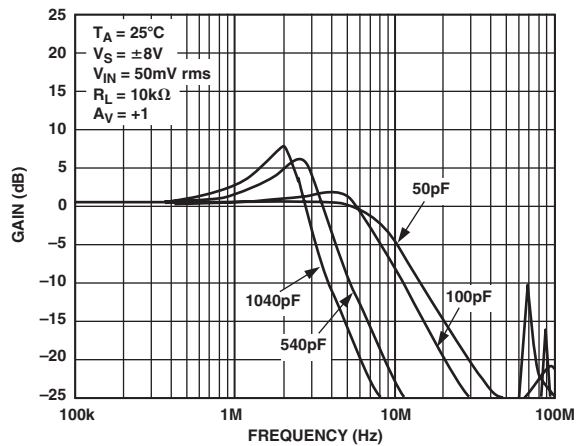

TPC 14. Capacitive Loading vs. Frequency Response

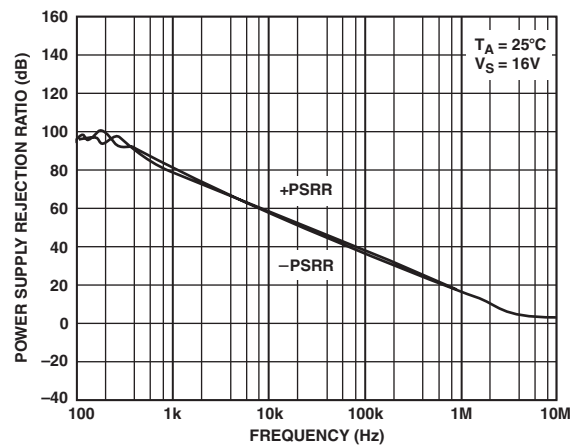

TPC 17. Power Supply Rejection Ratio vs. Frequency, $V_S = 16\text{ V}$

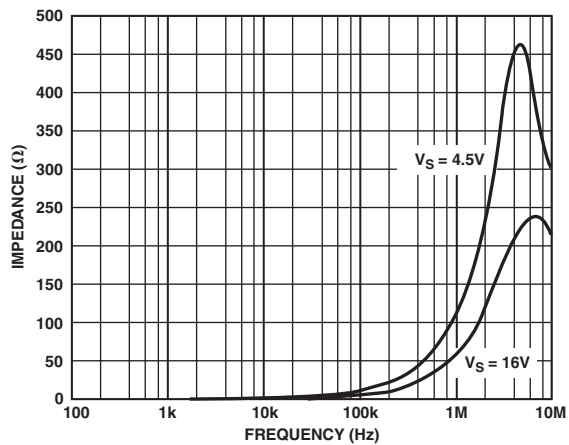

TPC 15. Closed-Loop Output Impedance vs. Frequency

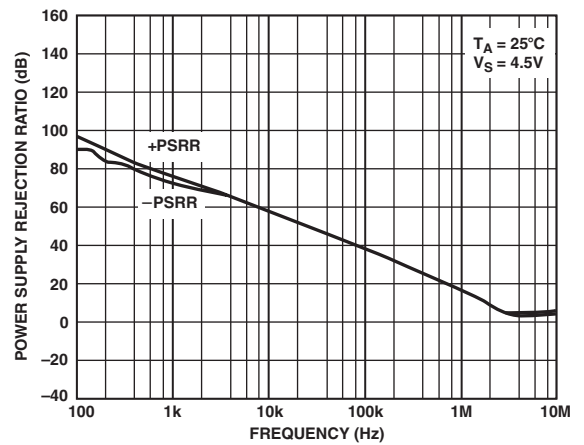

TPC 18. Power Supply Rejection Ratio vs. Frequency, $V_S = 4.5\text{ V}$

ADP3041

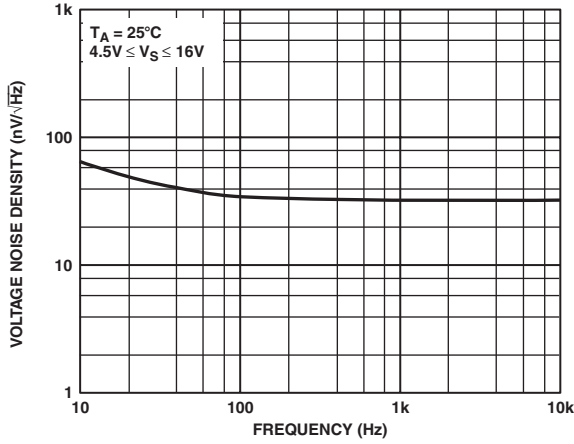

TPC 19. Voltage Noise Density vs. Frequency

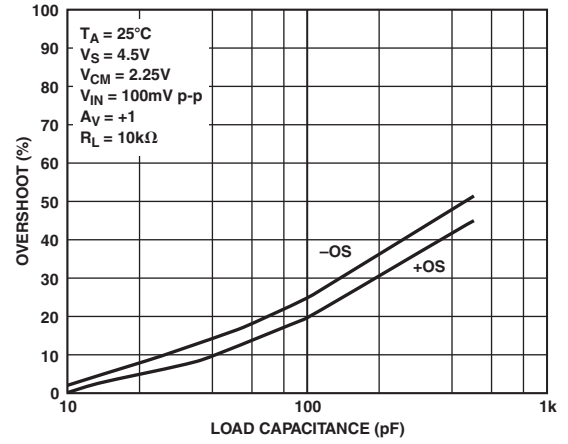

TPC 22. Small Signal Overshoot vs. Load Capacitance, $V_S = 4.5 V$

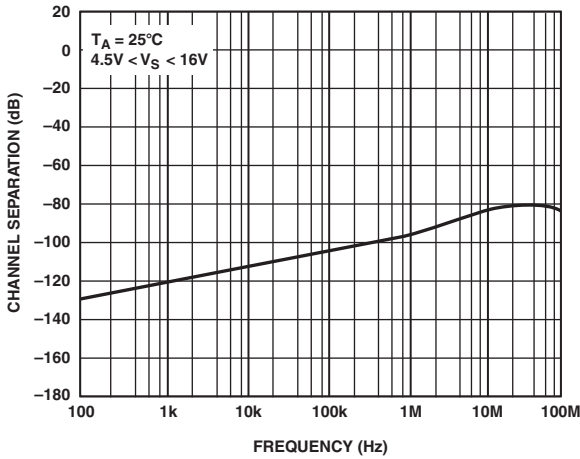

TPC 20. Channel Separation vs. Frequency

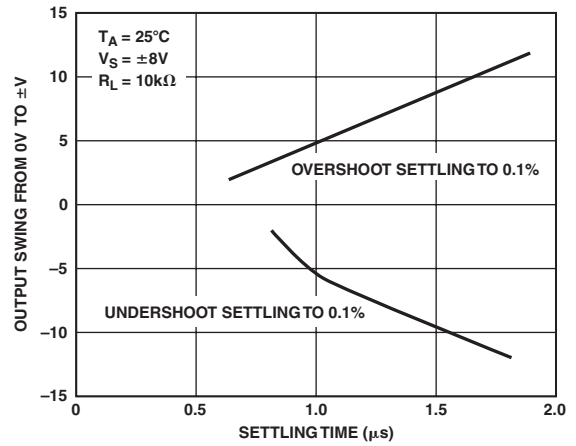

TPC 23. Step Size vs. Settling Time

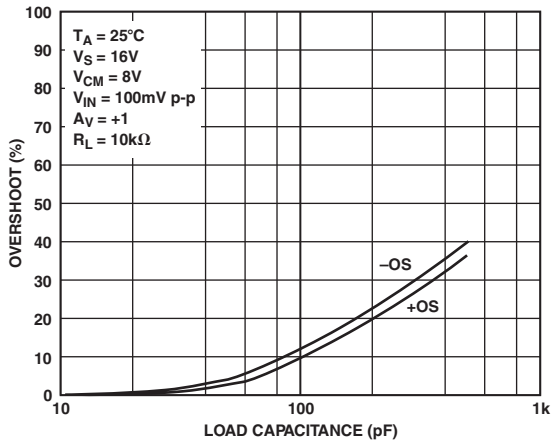

TPC 21. Small Signal Overshoot vs. Load Capacitance, $V_S = 16 V$

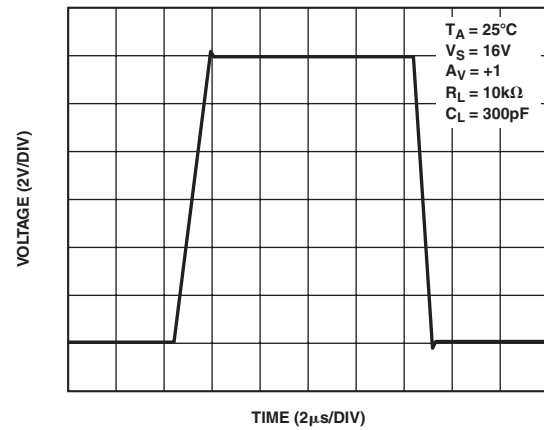

TPC 24. Large Signal Transient Response, $V_S = 16 V$

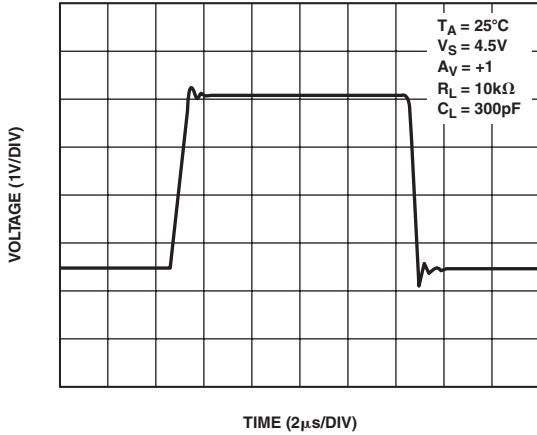

TPC 25. Large Signal Transient Response, $V_S = 4.5\text{ V}$

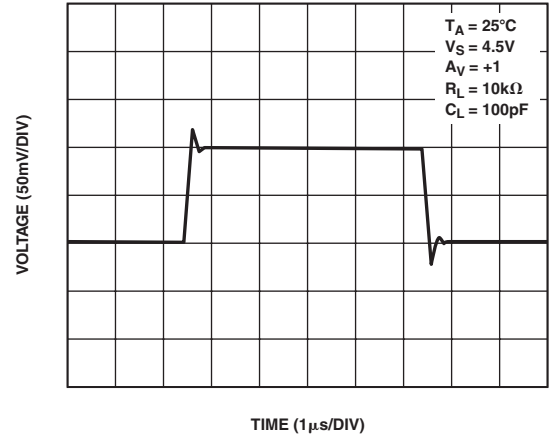

TPC 27. Small Signal Transient Response, $V_S = 4.5\text{ V}$

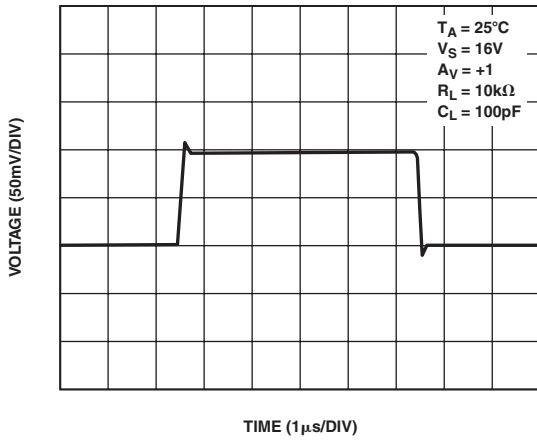

TPC 26. Small Signal Transient Response, $V_S = 16\text{ V}$

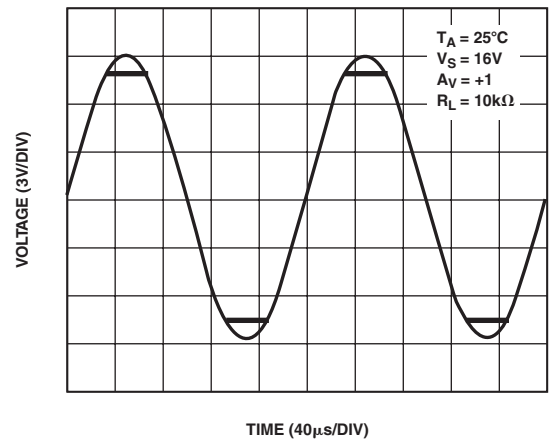

TPC 28. No Phase Reversal

ADP3041

THEORY OF OPERATION

Switching Regulator

The ADP3041 is a boost converter driver that stores energy from an input voltage in an inductor and delivers that energy, augmented by the input, to a load at a higher output voltage. It includes a voltage reference and an error amplifier to compare some fraction of the load voltage to the reference and to amplify any difference between them. The amplified error signal is compared to a dynamic signal produced by an internal ramp generator incorporating switch current feedback. The comparator output timing sets the duty ratio of a switch driving the inductor to maintain the desired output voltage.

Referring to Figure 1, a typical application powers both the IC and the inductor from the same input voltage. The on-chip MOSFET is driven on, pulling the SW pin close to PGND. The resulting voltage across the inductor causes its current to increase approximately linearly, with respect to time.

When the MOSFET switch is turned off, the inductor current cannot drop to zero, and so this current drives the SW node capacitance rapidly positive until the diode becomes forward biased. The inductor current now begins to charge the load capacitor, causing a slight increase in output voltage. Generally, the load capacitor is made large enough that this increase is very small during the time the switch is off. During this time, inductor current is also delivered to the load. In steady state operation, the inductor current exceeds the load current, and the excess is what charges the load capacitor. The inductor current falls during this time, though not necessarily to zero.

During the next cycle, initiated by the on-chip oscillator, the switch is again turned on so that the inductor current is ramped up again. The charge on the load capacitor provides load current during that interval. The remainder of the chip is arranged to control the duty ratio of the switch to maintain a chosen output voltage despite changes in input voltage or load current.

The output voltage is scaled down by a resistor voltage divider and presented to the g_m amplifier. This amplifier operates on the difference between an on-chip reference and the voltage at the FB pin so as to bring them to balance. This is when the output voltage equals the reference voltage multiplied by the resistor voltage divider ratio.

The g_m amplifier drives an internal comparator, which has at its other input a positive-going ramp produced by the oscillator and modified by the current sense amplifier. The MOSFET switch is turned on as the modified ramp voltage rises. When this voltage exceeds the output of the g_m amplifier, the comparator turns off the switch by resetting the flip-flop previously set by the oscillator. The output of the flip-flop is buffered by a high current driver, which turned on the MOSFET switch at the beginning of the oscillator cycle.

In the steady state with constant load and input voltage, the current in the inductor cycles around some average current level. The increasing ramp of current depends on input voltage and t_1 , the switch-on time, while the decreasing ramp depends on the difference between the input and output voltage and t_2 , the remainder of the cycle. For the peaks of these two ramps

to be equal and opposite to maintain steady state, one can say that $t_1 \times V_{IN}$ will equal $t_2 \times (V_{OUT} - V_{IN})$, if we neglect the effect of resistance in the inductor and switch and the forward voltage drop of the diode. From this equality one can derive $t_1/T = 1 - V_{IN}/V_{OUT}$, where T is the period of a cycle, $t_1 + t_2$. This result gives us the switch duty ratio, t_1/T , in terms of the input and output voltages.

In practice, the duty ratio needs to be slightly higher than this calculation. Because of series resistance in the inductor and the switch, the voltage across the actual inductance is somewhat less than the applied V_{IN} , and the actual output voltage is less than our approximation by the amount of the diode forward voltage drop. However, the feedback control within the ADP3041 adjusts the duty ratio to maintain the output voltage. Changes in load current and input voltage are also accommodated by the feedback control.

Changes in load current alone require a change in duty ratio in order to change the average inductor current. Once the inductor current adapts to the new load current, the duty ratio should return to nearly its original value, as one can see from the duty cycle calculation, which depends on input and output voltages but not on current. Increasing the switch duty ratio initially reduces the output voltage until the average inductor current increases enough to offset the reduction of the t_2 interval. By limiting the duty ratio, one can prevent this effect from regeneratively increasing the duty ratio to 100%, which would cause the output to fall and the switch current to rise without limit. The duty ratio is limited to about 80% by the design of the oscillator and an additional flip-flop reset.

A comparator compares the current sense amplifier output to a factory set limit that resets the flip-flop, turning off the switch. This prevents runaway or overload conditions from damaging the switch and reflecting fault overloads back to the input. Of course, the load is directly connected to the input by way of the diode and inductor, so protection against short circuited loads must be done at the power input.

The g_m amplifier has high voltage gain to ensure the output voltage accuracy and invariance with load and input voltage. However, because it is a g_m amplifier with a specified current response to input signal voltages, its high frequency response can be controlled by the compensation impedance. This permits the high frequency gain of the g_m amplifier to be optimized for the best compromise between speed of response and frequency stability.

The stable closed-loop bandwidth of the system can be extended by the current feedback shown. A signal representing the magnitude of the switch current is added to the ramp. This dynamically reduces the duty ratio as the current in the inductor increases, until the g_m amplifier restores it, improving the closed-loop frequency stability.

Soft Start

The soft start pin can load the COMP pin, forcing a low duty cycle when its voltage is low. A capacitor on SS initially holds the pin low; however, a small internal current charges the capacitor, causing SS to rise after SD goes high. As it rises,

COMP is allowed to rise slowly until the control loop limits the voltage to that required for regulation. SS continues to rise and no longer affects COMP once soft start is complete.

When \overline{SD} goes low, an internal switch discharges the SS capacitor to return its voltage to zero for soft restart.

Because of the large current that flows into the main MOSFET switch, it is provided with a separate PGND return to the negative supply terminal to avoid corrupting the small-signal return, GND, that can be used as a sense line at the output load point.

Buffers

This family of buffers is designed to drive large capacitive loads in LCD applications. Each has high output current drive and rail-to-rail input/output operation and can be powered from a single 12 V supply. They are also intended for other applications where low distortion and high output current drive are needed.

Input Overvoltage Protection

As with any semiconductor device, whenever the input exceeds either supply voltage, attention needs to be paid to the input overvoltage characteristics. As an overvoltage occurs, the amplifier could be damaged, depending on the voltage level and the magnitude of the fault current. When the input voltage exceeds either supply by more than 0.6 V, the internal pin junctions allow current to flow from the input to the supplies.

This input current is not inherently damaging to the device as long as it is limited to 5 mA or less. If a condition exists using the buffers where the input exceeds the supply more than 0.6 V, a series external resistor should be added. The size of the resistor can be calculated by using the maximum overvoltage divided

by 5 mA. This resistance should be placed in series with the input exposed to an overvoltage.

Output Phase Reversal

The buffer family is immune to phase reversal. Although the device's output does not change phase, large currents due to input overvoltage could damage the device. In applications where the possibility of an input voltage exceeding the supply voltage exists, overvoltage protection should be used as described in the previous section.

APPLICATION INFORMATION

Output Voltage

The ADP3041 operates with an adjustable output from V_{IN} to 12 V. The output voltage is fed back to the ADP3041 via resistor dividers $R1$ and $R2$ (Figure 1). The feedback voltage is 1.233 V, so the output voltage is set by the formula

$$V_{OUT} = 1.233V \times \left(1 + \frac{R1}{R2}\right) \quad (1)$$

Because the feedback bias current is 100 nA maximum, $R2$ may have a value up to 100 k Ω with minimum error due to the bias current.

Inductor Selection

For most applications, the inductor used with the ADP3041 should be in the range of 1 μ H to 22 μ H. Several inductor manufacturers are listed in Table I. When selecting an inductor, it is important to make sure that the inductor used with the ADP3041 is able to handle a peak current without saturation, and that the peak current is below the current limit of the ADP3041.

Table I. Inductor Manufacturers

Part	L (μ H)	Max DCR (m Ω)	Height (mm)	Vendor
CMD4D11-4R7M	4.7	166	1.1	Sumida
CCDRH5D18-100	10	124	2.0	847-545-6700
CR43-4R7	4.7	109	3.5	www.sumida.com
CR43-100	10	182	3.5	
DS1608-472	4.7	60	2.9	Coilcraft
DS1608-103	10	75	2.9	847-639-6400 www.coilcraft.com
D52LC-4R7M	4.7	84	2.0	Toko
D52LC-100M	10	137	2.0	847-297-0070 www.tokoam.com

ADP3041

As a rule, powdered iron cores saturate softly, whereas ferrite cores saturate abruptly. Open drum core inductors tend to saturate gradually and are low cost and small in size, making these types of inductors attractive in many applications. However, care must be exercised in their placement because they have high magnetic fields. In applications that are sensitive to magnetic fields, shielded geometrics are recommended.

In addition, inductor losses must be considered. Both core and copper losses contribute to loss in converter efficiency. To minimize core losses, look for inductors rated for operation at high switching frequencies. To minimize copper losses, it is best to use low dc resistance inductors. Typically, it is best to use an inductor with a dc resistance lower than 20 mΩ per μH.

The inductor value can be estimated using

$$L = (V_{OUT} - V_{IN}) \times M_{SLOPE} \quad (2)$$

where M_{SLOPE} is the scaling factor for the proper slope compensation.

$$M_{SLOPE} = \frac{1.456}{f_{SW}} \quad (3)$$

Choose the closest standard inductor value as a starting point.

The corresponding peak inductor current can then be calculated.

$$I_L(PEAK) = \left(I_{OUT} \times \frac{V_{OUT}}{V_{IN}} \right) + \frac{1}{2} \left(\frac{V_{IN} \times (V_{OUT} - V_{IN})}{L \times V_{OUT} \times f_s} \right) \quad (4)$$

It is recommended to try several different inductor values, sizes, and types to find the best inductor for the application. In general, large inductor values lead to lower ripple current, less output noise, and either larger size or higher dc resistance. Conversely, low inductor values lead to higher ripple current, more noise, and either smaller size or lower dc resistance. The final inductor selection should be based on the best trade-off of size, cost, and performance.

Capacitor Selection

The ADP3041 requires an input capacitor to reduce the switching ripple and noise on the IN pin. The value of the input capacitor depends on the application. For most applications, a minimum of 10 μF is required. For applications that are running close to current limit or that have large transient loads, input capacitors in the range of 22 μF to 47 μF are required.

The selection of the output capacitor also depends on the application. Given the allowable output ripple voltage, ΔV_{OUT} , the criteria for selecting the output capacitor can be calculated using

$$C_{OUT} \geq 8 \times I_{OUT} \left(\frac{(V_{OUT} - V_{IN})}{f_s \times V_{OUT} \times \Delta V_{OUT}} \right) \quad (5)$$

$$ESR_{C_{OUT}} \leq \frac{\Delta V_{OUT}}{I_L(PEAK)} \quad (6)$$

When selecting an output capacitor, make sure that the ripple current rating is sufficient to cover the rms switching current of the ADP3041. The ripple current in the output capacitor is given by

$$I_{RMS}(C_{OUT}) = I_{OUT} \sqrt{\frac{V_{OUT} - V_{IN}}{V_{IN}}} \quad (7)$$

Multilayer ceramic capacitors are a good choice since they have low ESR, high ripple current rating, and a very small package size. Tantalum or OS-CON capacitors can be used; however, they have a larger package size and higher ESR. Table II lists some capacitor manufacturers. Consult the manufacturer for more information.

Table II. Capacitor Manufacturers

Vendor	Phone No.	Web Address
AVX	843-448-9411	www.avxcorp.com
Murata	770-436-1300	www.murata.com
Sanyo	408-749-9714	www.sanyovideo.com
Taiyo Yuden	858-554-0755	www.t-yuden.com

Diode Selection

In specifying a diode, consideration must be given to speed, forward current, forward voltage drop, reverse leakage current, and the breakdown voltage. The output diode should be rated to handle the maximum output current. If the output can be subjected to accidental short circuits, then the diode must be rated to handle currents up to the current limit of the ADP3041. The breakdown rating of the diode must exceed the output voltage. A high speed diode with low forward drop and low leakage will help improve the efficiency of the converter by lowering the losses of the diode. Schottky diodes are recommended.

Loop Compensation

Like most current programmed PWM converters, the ADP3041 needs compensation to maintain stability over the operating conditions of the particular application. For operation at duty cycles above 50%, the choice of inductor is critical in maintaining stability. If the slope of the inductor current is too small or too large, the circuit will be unstable. See the Inductor Selection section for more information on choosing the proper inductor.

The ADP3041 provides a pin (COMP) for compensating the voltage feedback loop. This is done by connecting a series R_C network from the COMP pin to GND (see Figure 2). For most applications, the compensation resistor, R_C , should be in the range of 5 kΩ < R_C < 400 kΩ, and the compensation capacitor, C_C , in the range of 100 pF < C_C < 10 nF. Further details for selecting the compensation components follow.

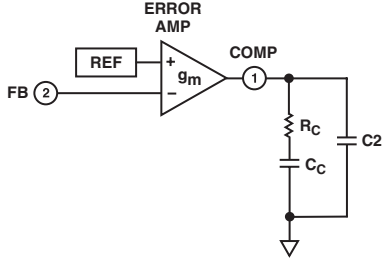

Figure 2. Compensation Components

The boost regulator introduces a right half plane (RHP) zero. This zero behaves like a zero with respect to the gain but behaves like a pole with respect to phase. As a result, the RHP zero can cause instability of the control loop if the bandwidth (in Hertz) of the loop includes it.

$$f_z(RHP) = \left(\frac{V_{IN}}{V_{OUT}} \right)^2 \times \frac{R_{LOAD}}{2\pi \times L} \quad (8)$$

Note that the RHP zero is dependant on the load. To optimize the compensation, a nominal load must be chosen. Typically, choosing an R_{LOAD} that is halfway between no load and full load works well; but make sure that this load is enough to ensure CCM operation. The critical value of load resistance, R_{CRIT} , for CCM is given by

$$R_{CRIT} = \frac{2 \times L \times f_{SW}}{\left(1 - \frac{V_{IN}}{V_{OUT}} \right) \left(\frac{V_{IN}}{V_{OUT}} \right)^2} \quad (9)$$

So for the nominal load resistance R_{LOAD} , use the half load resistance or R_{CRIT} , whichever is lower.

To make sure the RHP zero does not cause stability problems, the control loop bandwidth should be set at around 1/8 the frequency (in Hertz) of the RHP zero.

$$f_C = \frac{1}{8} \times f_z(RHP) \quad (10)$$

where f_C is the crossover frequency.

Another frequency of interest is the pole caused by the output load and output capacitor. This frequency (in Hertz) is calculated using

$$f_{P1} = \frac{1}{2\pi \times R_{LOAD} \times C_{OUT}} \quad (11)$$

Note that the frequency varies with load current. Again, use the nominal load resistance for the calculation.

So the compensation resistor, R_C , can be calculated by determining the open-loop gain at the crossover frequency, f_C , and setting R_C to adjust the closed-loop gain to zero. The open-loop gain can be approximated (in dB) by

$$G_{OC}(f_C) = 20 \log \left(\frac{V_{IN} \times R_{LOAD}}{V_{OUT} \times 0.65} \right) - 20 \log \left(\sqrt{1 + \left(\frac{f_C}{f_{P1}} \right)^2} \right) \quad (12)$$

$$R_C = \frac{1}{g_m \times \frac{V_{FB}}{V_{OUT}} \times 10^{\frac{G_{OC}(f_C)}{20}}} \quad (13)$$

Once the value of the compensation resistor is determined, the value of the compensation capacitor, C_C , can be calculated. The compensation capacitor sets up a zero to cancel out the pole created by the output load, f_{P1} . Since the load pole position varies with load current, the compensation zero should be located approximately four times the worst-case load pole, $4 \times f_{P1}$, or at one half the crossover frequency, $1/2 \times f_C$, whichever is lower. The frequency of the compensation zero is located at

$$f_{ZC} = \frac{1}{2 \times \pi \times R_C \times C_C} \quad (14)$$

So, the value of C_C can be calculated using

$$C_C = \frac{1}{2 \times \pi \times f_{ZC} \times R_C} \quad (15)$$

If the output capacitor selected has a high ESR value, it may be necessary to add another pole to cancel the zero introduced by the capacitor's ESR. The ESR zero location is determined by

$$f_z(ESR) = \frac{1}{2 \times \pi \times R_{ESR} \times C_{OUT}} \quad (16)$$

So, a high frequency pole should be placed to cancel the ESR zero or at half the switching frequency, whichever is lower. By placing a pole at half the switching frequency, the high frequency gain is rolled off for better phase margin. Note that the high frequency pole must be at least a decade above the compensation zero in order for the compensation to work properly. If this is not the case, the high frequency pole should not be used.

$$C2 = \frac{C_C}{1 + \left(2\pi \times f_{P(HF)} \times R_C \times C_C \right)} \quad (17)$$

After all the compensation components have been selected, the best check for stability and response time is to observe the transient performance of the ADP3041. Adjust R_C and C_C as necessary to optimize the transient response. Increasing R_C increases

ADP3041

the high frequency gain. Increasing C_C decreases the compensation zero frequency, which increases the stability but slows the transient response.

Shutdown

The ADP3041 shuts down to reduce the supply current to a $10\ \mu\text{A}$ maximum when the shutdown pin is pulled low. In this mode, the internal reference, error amplifier, comparator, biasing circuitry, and the internal MOSFET switch are turned off. Note that the output is still connected to the input via the inductor and Schottky diode when in shutdown.

Layout Procedure

To get high efficiency, good regulation, and stability, a good printed circuit board layout is required. It is strongly recommended that the evaluation board layout be followed as closely

as possible. Use the following general guidelines when designing printed circuit boards (see Figure 1):

1. Keep C_{IN} close to the IN pin of the ADP3041.
2. Keep the high current path from C_{IN} through L1 to the SW pin and PGND pin as short as possible.
3. Similarly, keep the high current path from C_{IN} through L1, D1, and C_{OUT} as short as possible.
4. Keep high current traces as short and wide as possible.
5. Place the feedback resistors as close to the FB pin as possible to prevent noise pickup.
6. Place the compensation components as close to the COMP pin as possible.
7. Avoid routing noise sensitive traces near the high current traces and components.

OUTLINE DIMENSIONS

20-Lead Thin Shrink Small Outline Package [TSSOP]
(RU-20)

Dimensions shown in millimeters

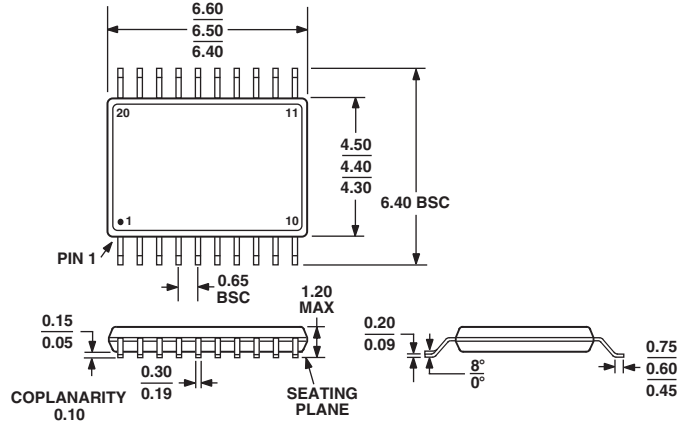

ADP3041

Revision History

Location	Page
12/03—Data Sheet changed from REV. C to REV. D.	
Updated ORDERING GUIDE	4
Updated formatting of Typical Performance Characteristics	5
Change to TPC 1	5
Changes to Table I	11
Changes to Table II	12
5/03—Data Sheet changed from REV. B to REV. C.	
Replaced all TPCs	5
Updated OUTLINE DIMENSIONS	15
10/02—Data Sheet changed from REV. A to REV. B.	
Updated Features	1
Removed RT Pin	4

C03361-0-12/03(D)