

# SP2574NUTG 2.5V 40A Diode Array

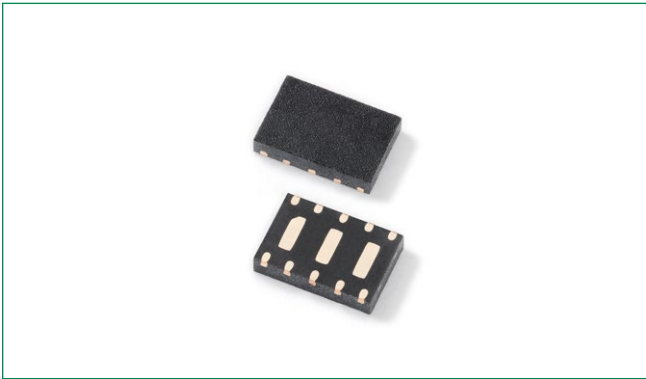

## Description

The SP2574NUTG is a low-capacitance, TVS Diode Array designed to provide protection against ESD (electrostatic discharge), CDE (cable discharge events), EFT (electrical fast transients), and lightning induced surges for high-speed, differential data lines. It's packaged in a  $\mu$ DFN package (3.0 x 2.0mm) and each component can protect up to 4 channels or 2 differential pairs, up to 40A (IEC 61000-4-5) and up to 30kV ESD (IEC 61000-4-2). The "flow-through" design minimizes signal distortion, reduces voltage overshoot, and provides a simplified PCB design.

The SP2574NUTG with its low capacitance and low clamping voltage makes it ideal for high-speed data interfaces such as 1GbE applications found in notebooks, switches, etc.

## Pinout

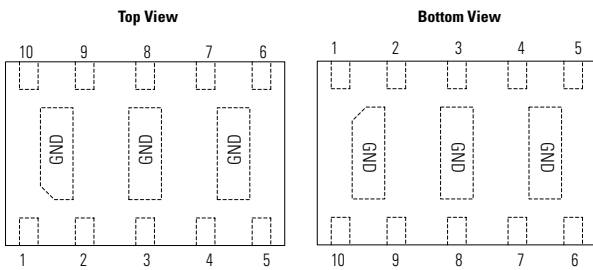

**NOTE:** PIN3, PIN8 are same potential with GND

## Features

- ESD, IEC 61000-4-2,  $\pm 30$ kV contact,  $\pm 30$ kV air
- EFT, IEC 61000-4-4, 40A (5/50ns)
- Lightning, 40A (8/20 $\mu$ s as defined in IEC 61000-4-5 2nd Edition)
- Low capacitance of 3.8pF@0V (TYP) per I/O
- Low leakage current of 0.1 $\mu$ A (TYP) at 2.5V
- $\mu$ DFN-10 package is optimized for high-speed data line routing
- Provides protection for two differential data pairs (4 channels) up to 40A
- Low operating and clamping voltage
- AEC-Q101 qualified

## Functional Block Diagram

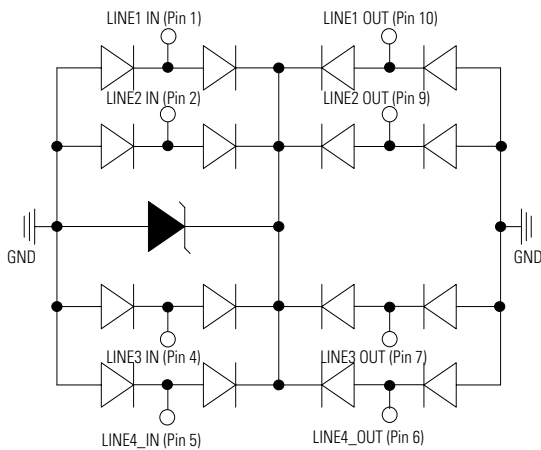

## Applications

- 10/100/1000 Ethernet
- WAN/LAN Equipment
- Desktops, Servers and Notebooks
- LVDS Interfaces
- Integrated Magnetics
- Smart TV

## Application Example

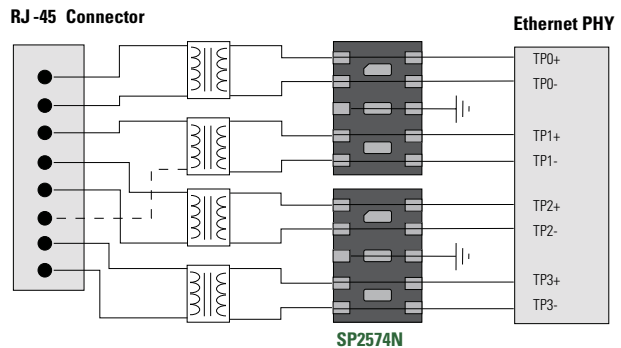

Life Support Note:

**Not Intended for Use in Life Support or Life Saving Applications**

The products shown herein are not designed for use in life sustaining or life saving applications unless otherwise expressly indicated.

**Absolute Maximum Ratings**

Symbol	Parameter	Value	Units
$I_{PP}$	Peak Current ( $t_p=8/20\mu s$ )	40 <sup>1</sup>	A
$P_{Pk}$	Peak Pulse Power ( $t_p=8/20\mu s$ )	1000	W
$T_{OP}$	Operating Temperature	-40 to 125	°C
$T_{STOR}$	Storage Temperature	-55 to 150	°C

**Notes:**1. Rating with 2 pins connected together per suggested diagram ( For example, pin1 is connected to pin 10, pin 2 is connected to Pin 9, Pin 4 is connected to pin 7 and pin 5 is connected to pin 6)

**CAUTION:** Stresses above those listed in "Absolute Maximum Ratings" may cause permanent damage to the component. This is a stress only rating and operation of the component at these or any other conditions above those indicated in the operational sections of this specification is not implied.

**Electrical Characteristics ( $T_{OP}=25^\circ C$ )**

Parameter	Symbol	Test Conditions	Min	Typ	Max	Units
Reverse Standoff Voltage	$V_{RWM}$	$I_R \leq 1\mu A$			2.5	V
Reverse Leakage Current	$I_R$	$V_{RWM} = 2.5V, T = 25^\circ C$		0.1	0.5	$\mu A$
Breakdown Voltage	$V_{BR}$	$I_{t1} = 1\mu A$	3.0	3.7	4.5	V
Snap Back Voltage	$V_{SB}$	$I_H = 1mA$	3.0			V
Clamp Voltage	$V_C$	$I_{PP} = 1A, t_p = 8/20\mu s$ Any I/O to Ground			4.5	V
		$I_{PP} = 10A, t_p = 8/20\mu s$ Any I/O to Ground			7.5	
		$I_{PP} = 25A, t_p = 8/20\mu s$ Any I/O to Ground			12.0	
		$I_{PP} = 40A, t_p = 8/20\mu s$ Line-to-Line <sup>1</sup> , two I/O Pins connected together on each line			20.0	
Dynamic Resistance <sup>2</sup>	$R_{DYN}$	TLP, $t_p=100ns$ , Any I/O to Ground		0.13		$\Omega$
ESD Withstand Voltage	$V_{ESD}$	IEC 61000-4-2 (Contact)	$\pm 30$			kV
		IEC 61000-4-2 (Air)	$\pm 30$			kV
Diode Capacitance	$C_{I/O \text{ to GND}}$	Between I/O Pins and Ground $V_R = 0V, f = 1MHz$		3.8	5.0	pF
	$C_{I/O \text{ to I/O}}$	Between I/O Pins $V_R = 0V, f = 1MHz$		1.7		pF

**Notes:**

- Rating with 2 pins connected together per suggested diagram ( For example, pin1 is connected to pin 10, pin 2 is connected to Pin 9, Pin 4 is connected to pin 7 and pin 5 is connected to pin 6)
- Transmission Line Pulse (TLP) with 100ns width, 2ns rise time, and average window  $t1=70ns$  to  $t2=90ns$

**Normalized Capacitance vs. Voltage**

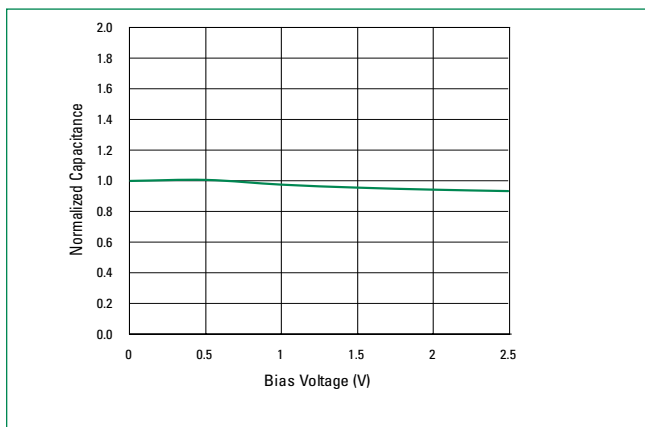

**Insertion Loss (S21)**

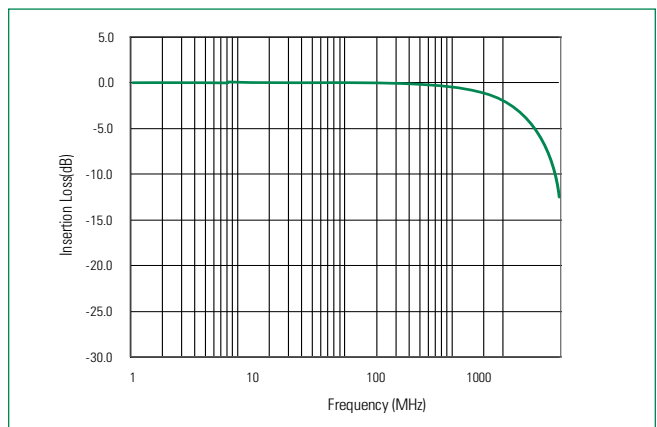

**Clamping Voltage vs.  $I_{pp}$  (I/O to GND)**

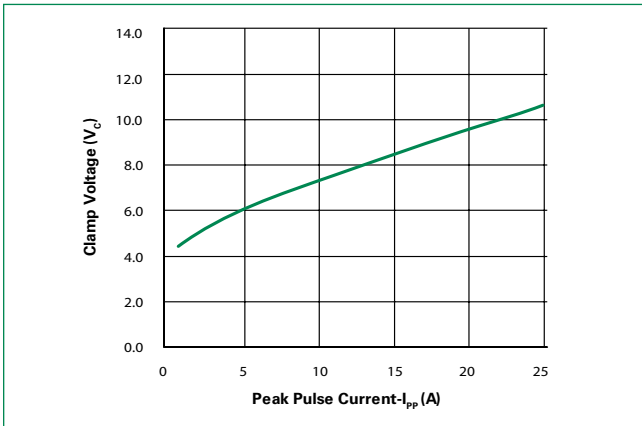

**Clamping Voltage vs.  $I_{pp}$  (Line-to-Line, Two I/O Pins Connected Together)**

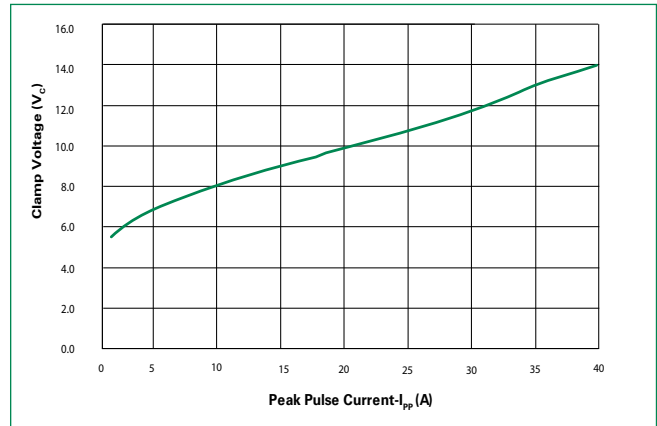

**8/20 $\mu$ s Pulse Waveform**

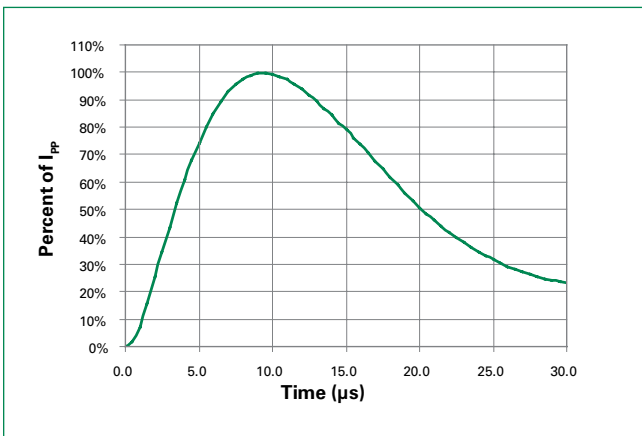

**Non-Repetitive Peak Pulse Power vs. Pulse Time**

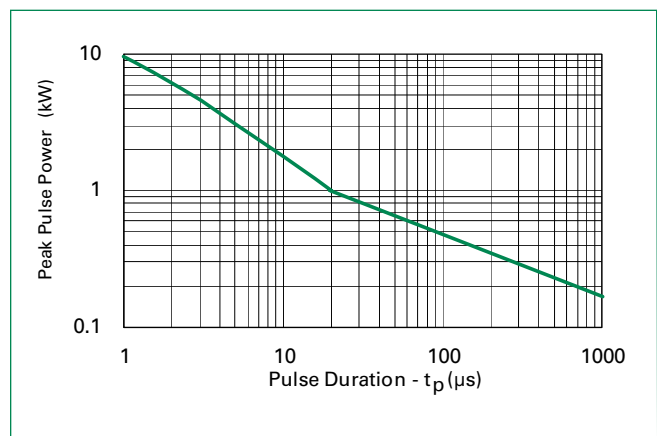

**Transmission Line Pulse (TLP)**

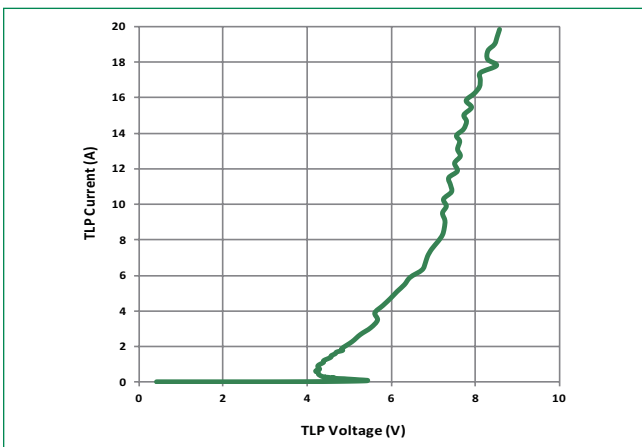

### Soldering Parameters

<b>Reflow Condition</b>		Pb – Free assembly
<b>Pre Heat</b>	- Temperature Min ( $T_{s(min)}$ )	150°C
	- Temperature Max ( $T_{s(max)}$ )	200°C
	- Time (min to max) ( $t_s$ )	60 – 180 secs
<b>Average ramp up rate (Liquidus) Temp (<math>T_L</math>) to peak</b>		3°C/second max
<b><math>T_{s(max)}</math> to <math>T_L</math> - Ramp-up Rate</b>		3°C/second max
<b>Reflow</b>	- Temperature ( $T_L$ ) (Liquidus)	217°C
	- Temperature ( $t_L$ )	60 – 150 seconds
<b>Peak Temperature (<math>T_p</math>)</b>		260 <sup>+0/-5</sup> °C
<b>Time within 5°C of actual peak Temperature (<math>t_p</math>)</b>		20 – 40 seconds
<b>Ramp-down Rate</b>		6°C/second max
<b>Time 25°C to peak Temperature (<math>T_p</math>)</b>		8 minutes Max.
<b>Do not exceed</b>		260°C

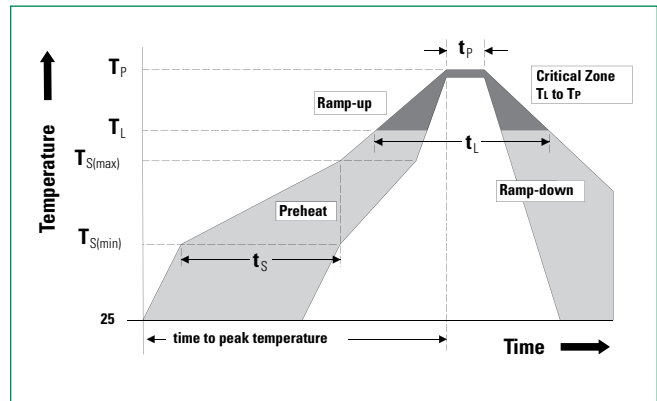

### Product Characteristics

<b>Lead Plating</b>	Pre-Plated Frame
<b>Lead Material</b>	Copper Alloy
<b>Lead Coplanarity</b>	0.004 inches(0.102mm)
<b>Substrate material</b>	Silicon
<b>Body Material</b>	Molded Compound
<b>Flammability</b>	UL Recognized compound meeting flammability rating V-0

### Ordering Information

Part Number	Package	Min. Order Qty.
SP2574NUTG	μDFN-10 (3.0x2.0mm)	3000

### Part Numbering System

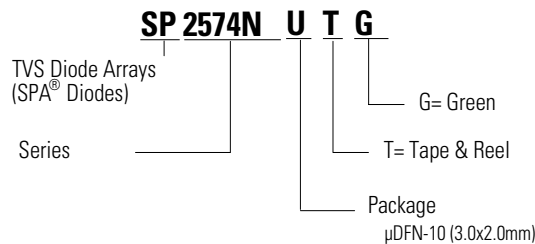

### Part Marking System

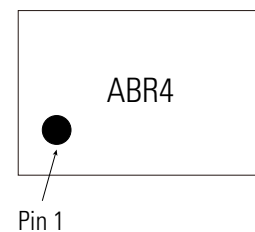

**Package Dimensions —  $\mu$ DFN-10 (3.0x2.0mm)**

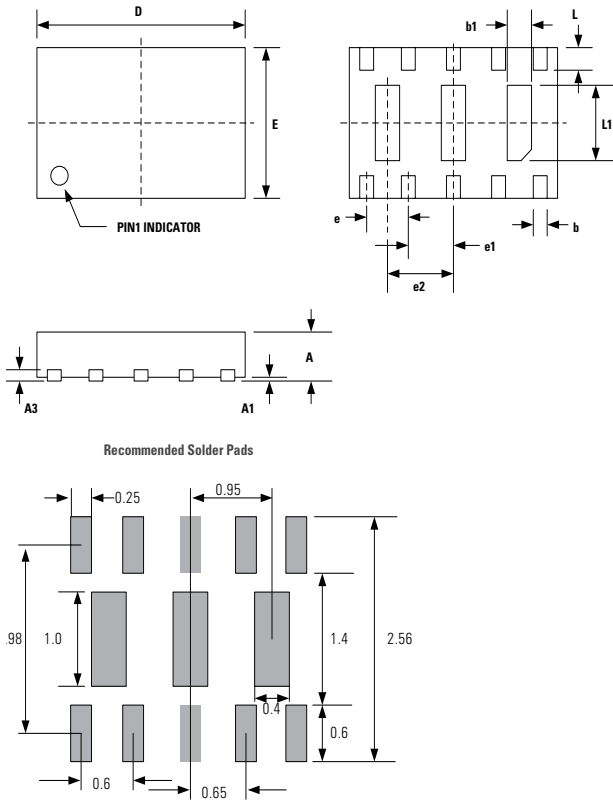

Package	$\mu$ DFN-10 (3.0x2.0mm)					
JEDEC	MO-229					
Symbol	Millimeters			Inches		
	Min	Nom	Max	Min	Nom	Max
<b>A</b>	0.50	0.60	0.65	0.020	0.024	0.026
<b>A1</b>	0.00	0.03	0.05	0.000	0.001	0.002
<b>A3</b>	0.15 Ref			0.006 Ref		
<b>b</b>	0.15	0.20	0.25	0.006	0.008	0.010
<b>b1</b>	0.25	0.35	0.45	0.010	0.014	0.018
<b>D</b>	2.90	3.00	3.10	0.114	0.118	0.122
<b>E</b>	1.90	2.00	2.10	0.075	0.079	0.083
<b>e</b>	0.60 BSC			0.024 BSC		
<b>e1</b>	0.65 BSC			0.026 BSC		
<b>e2</b>	0.95 BSC			0.037		
<b>L</b>	0.25	0.30	0.35	0.010	0.012	0.014
<b>L1</b>	0.95	1.00	1.05	0.037	0.039	0.041

- Notes:**
1. All dimensions are in millimeters
  2. Dimensions include solder plating.
  3. Dimensions are exclusive of mold flash & metal burr

**Tape & Reel Specification —  $\mu$ DFN-10 (3.0x2.0mm)**

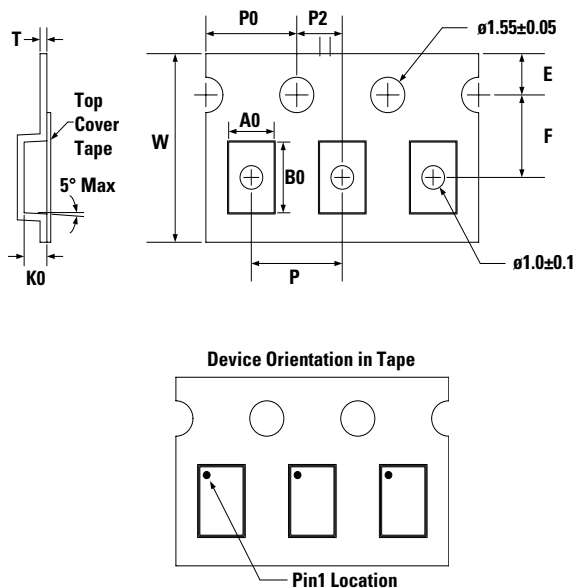

Package	$\mu$ DFN-10 (3.0x2.0mm)
Symbol	Millimeters
<b>A0</b>	2.30 +/- 0.10
<b>B0</b>	3.20 +/- 0.10
<b>E</b>	1.75 +/- 0.10
<b>F</b>	3.50 +/- 0.05
<b>K0</b>	1.0 +/- 0.10
<b>P</b>	4.00 +/- 0.10
<b>P0</b>	4.00 +/- 0.10
<b>P2</b>	2.00 +/- 0.10
<b>T</b>	0.3 +/- 0.05
<b>W</b>	8.00 + 0.30 /- 0.10

**Disclaimer Notice** - Information furnished is believed to be accurate and reliable. However, users should independently evaluate the suitability of and test each product selected for their own applications. Littelfuse products are not designed for, and may not be used in, all applications. Read complete Disclaimer Notice at <http://www.littelfuse.com/disclaimer-electronics>.