

**Data sheet | Item number: 231-202/026-000**

1-conductor female connector; CAGE CLAMP®; 2.5 mm<sup>2</sup>; Pin spacing 7.5 mm; 2-pole; 2,50 mm<sup>2</sup>; gray

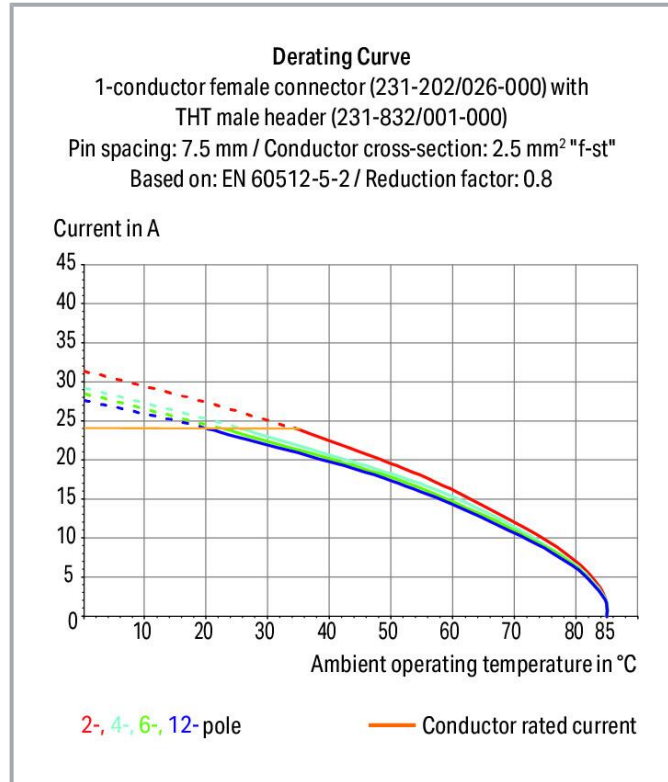

[www.wago.com/231-202/026-000](http://www.wago.com/231-202/026-000)

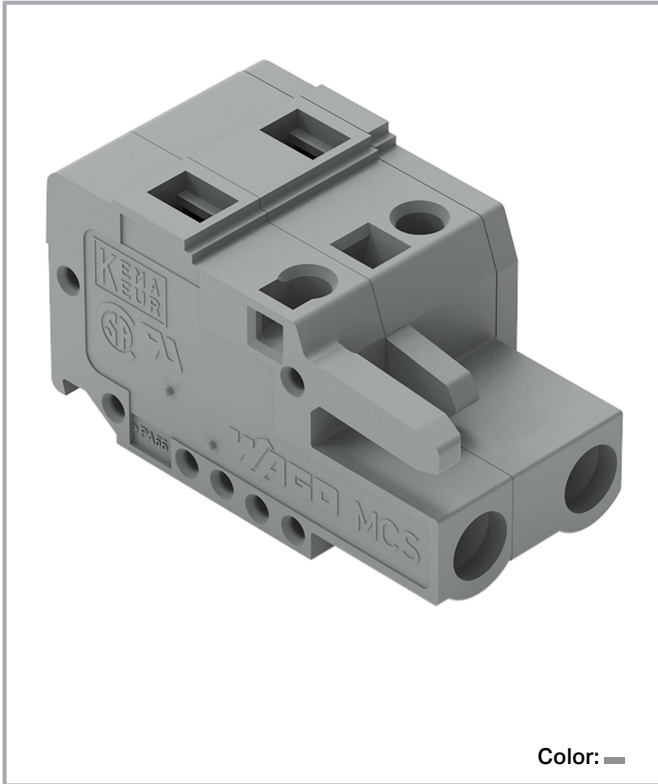

Subject to changes. Please also observe the further product documentation!

WAGO GmbH & Co. KG  
Hansastr. 27  
32423 Minden  
Phone: +49571 887-0 | Fax: +49571 887-169  
Email: [info.de@wago.com](mailto:info.de@wago.com) | Web: [www.wago.com](http://www.wago.com)

Do you have any questions about our products?  
We are always happy to take your call at +49 (571) 887-44222.

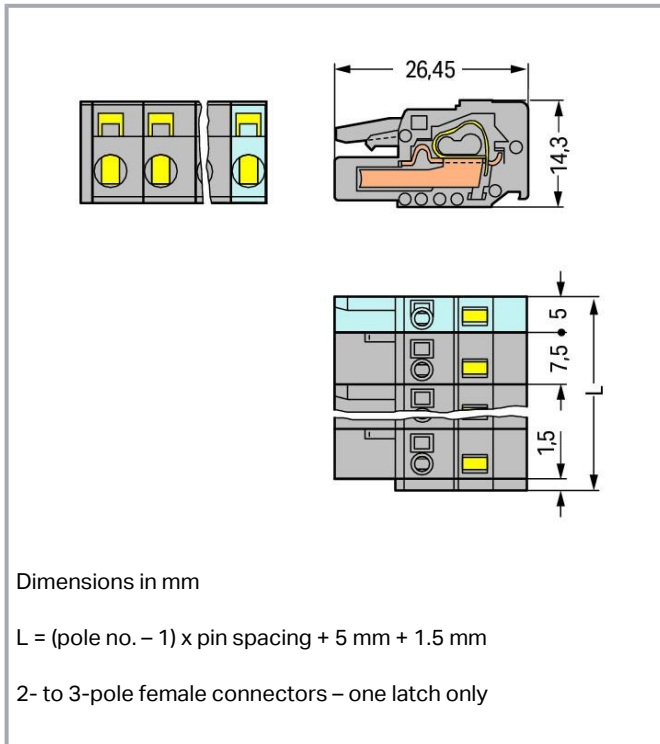

## Item description

- Universal connection for all conductor types
- Easy cable pre-assembly and on-unit wiring via vertical and horizontal CAGE CLAMP® actuation
- Integrated test ports
- With coding fingers

## Data

### Notes

#### Safety information

The *MCS – MULTI CONNECTION SYSTEM* includes connectors without breaking capacity in accordance with DIN EN 61984. When used as intended, these connectors must not be connected /disconnected when live or under load. When used as intended, these connectors must not be connected/disconnected when live or under load. The circuit design should ensure header pins, which can be touched, are not live when unmated.

#### Variants:

Gold-plated or partially gold-plated contact surfaces  
Other versions (or variants) can be requested from WAGO Sales or configured at <https://configurator.wago.com/>.

Subject to changes. Please also observe the further product documentation!



## Electrical data

### Ratings per IEC/EN

Ratings per	IEC/EN 60664-1
Nominal voltage (III/3)	500 V
Rated impulse voltage (III/3)	6 kV
Rated voltage (III/2)	630 V
Rated impulse voltage (III/2)	6 kV
Nominal voltage (II/2)	1000 V
Rated surge voltage (II/2)	6 kV
Rated current	16 A
Legend (ratings)	(III / 2) $\hat{=}$ Overvoltage category III / Pollution degree 2

### Ratings per UL 1059

Approvals per	UL 1059
Rated voltage UL (Use Group B)	300 V
Rated current UL (Use Group B)	15 A
Rated voltage UL (Use Group D)	300 V
Rated current UL (Use Group D)	10 A

### Ratings per UL 1977

Rated voltage (UL 1977)	600 V
Rated current UL 1977	15 A

### Ratings per CSA

Approvals per	CSA
Rated voltage CSA (Use Group B)	300 V
Rated current CSA (Use Group B)	15 A
Rated voltage CSA (Use Group D)	300 V
Rated current CSA (Use Group D)	10 A

## Connection data

Connection points	2
Total number of potentials	2
Number of connection types	1
Number of levels	1

Subject to changes. Please also observe the further product documentation!

## Connection 1

Connection technology	CAGE CLAMP®
Actuation type	Operating tool
Actuation direction 1	Operation parallel to conductor entry
Actuation direction 2	Operation perpendicular to conductor entry
Solid conductor	0.08 ... 2.5 mm <sup>2</sup> / 28 ... 12 AWG
Fine-stranded conductor	0.08 ... 2.5 mm <sup>2</sup> / 28 ... 12 AWG
Fine-stranded conductor; with insulated ferrule	0.25 ... 1.5 mm <sup>2</sup>
Fine-stranded conductor; with uninsulated ferrule	0.25 ... 2.5 mm <sup>2</sup>
Strip length	8 ... 9 mm / 0.31 ... 0.35 inches
Pole number	2
Conductor entry direction to mating direction	0°

## Physical data

Pin spacing	7.5 mm / 0.295 inches
Width	14 mm / 0.551 inches
Height	14.3 mm / 0.563 inches
Depth	26.45 mm / 1.041 inches

## Mechanical Data

Variable coding	Yes
Anti-rotation protection	Yes

## Plug-in connection

Contact type (pluggable connector)	Female connector/socket
Connector (connection type)	for conductor
Mismating protection	No
Plugging without loss of pin spacing	No
Locking of plug-in connection	none

## Material Data

Note (material data)	<a href="#">Information on material specifications can be found here</a>
Color	gray

Subject to changes. Please also observe the further product documentation!

Material group	I
Insulation material	Polyamide (PA66)
Flammability class per UL94	V0
Clamping spring material	Chrome-nickel spring steel (CrNi)
Contact material	Copper alloy
Contact plating	Tin
Fire load	0.129 MJ
Weight	4.1 g

### Environmental requirements

Limit temperature range	-60 ... +85 °C
Processing temperature	-35 ... +60 °C

### Commercial data

Product Group	3 (Multi Conn. System)
eCl@ss 10.0	27-44-03-09
eCl@ss 9.0	27-44-03-09
ETIM 8.0	EC002638
ETIM 7.0	EC002638
PU (SPU)	100 pcs
Packaging type	box
Country of origin	DE
GTIN	4044918343848
Customs tariff number	85366990990

### Environmental Product Compliance

RoHS Compliance Status	Compliant, No Exemption
------------------------	-------------------------

### Approvals / Certificates

#### General approvals

Logo	Approval	Additional Approval Text	Certificate name
	<b>CB</b> DEKRA Certification B.V.	IEC 61984	NL-39756 /A1
	<b>CSA</b> DEKRA Certification B.V.	C22.2	1466354



Subject to changes. Please also observe the further product documentation!

	<b>KEMA/KEUR</b> DEKRA Certification B.V.	EN 61984	71- 121453
	<b>UR</b> Underwriters Laboratories Inc.	UL 1059	E45172
	<b>UR</b> Underwriters Laboratories Inc.	UL 1977	E 45171

**Declarations of conformity and manufacturer's declarations**

Logo	Approval	Additional Approval Text	Certificate name
	<b>Railway</b> WAGO GmbH & Co. KG	-	Railway Ready

**Approvals for marine applications**

Logo	Approval	Additional Approval Text	Certificate name
	<b>ABS</b> American Bureau of Shipping	-	19- HG1869876- PDA
	<b>BV</b> Bureau Veritas S.A.	IEC 60998	11915/DO BV
	<b>DNV GL</b> Det Norske Veritas, Germanischer Lloyd	-	TAE000016Z

**Counterpart**

	Item no.231-232/001-000/105-604 THR male header; 1.0 x 1.0 mm solder pin; straight; Pin spacing 7.5 mm; 2-pole; black	<a href="http://www.wago.com/231-232/001-000/105-604">www.wago.com/231-232/001-000/105-604</a>
--	--	--

Subject to changes. Please also observe the further product documentation!



**Item no.231-232/001-000**

THT male header; 1.0 x 1.0 mm solder pin; straight; Pin spacing 7.5 mm; 2-pole; gray

[www.wago.com/231-232/001-000](http://www.wago.com/231-232/001-000)



**Item no.231-232/001-000/105-604/997-405**

THR male header; 1.0 x 1.0 mm solder pin; straight; in tape-and-reel packaging; Pin spacing 7.5 mm; 2-pole; black

[www.wago.com/231-232/001-000/105-604/997-405](http://www.wago.com/231-232/001-000/105-604/997-405)



**Item no.231-262/001-000**

THT male header; 1.2 x 1.2 mm solder pin; straight; Pin spacing 7.5 mm; 2-pole; gray

[www.wago.com/231-262/001-000](http://www.wago.com/231-262/001-000)



**Item no.231-262/001-000/105-604**

THR male header; 1.2 x 1.2 mm solder pin; straight; Pin spacing 7.5 mm; 2-pole; black

[www.wago.com/231-262/001-000/105-604](http://www.wago.com/231-262/001-000/105-604)



**Item no.231-262/001-000/105-604/997-405**

THR male header; 1.2 x 1.2 mm solder pin; straight; in tape-and-reel packaging; Pin spacing 7.5 mm; 2-pole; black

[www.wago.com/231-262/001-000/105-604/997-405](http://www.wago.com/231-262/001-000/105-604/997-405)



**Item no.231-832/001-000**

THT male header; 1.0 x 1.0 mm solder pin; angled; Pin spacing 7.5 mm; 2-pole; gray

[www.wago.com/231-832/001-000](http://www.wago.com/231-832/001-000)



**Item no.231-832/001-000/105-604**

THR male header; 1.0 x 1.0 mm solder pin; angled; Pin spacing 7.5 mm; 2-pole; black

[www.wago.com/231-832/001-000/105-604](http://www.wago.com/231-832/001-000/105-604)



**Item no.231-832/001-000/105-604/997-405**

THR male header; 1.0 x 1.0 mm solder pin; angled; in tape-and-reel packaging; Pin spacing 7.5 mm; 2-pole; black

[www.wago.com/231-832/001-000/105-604/997-405](http://www.wago.com/231-832/001-000/105-604/997-405)



**Item no.231-862/001-000**

THT male header; 1.2 x 1.2 mm solder pin; angled; Pin spacing 7.5 mm; 2-pole; gray

[www.wago.com/231-862/001-000](http://www.wago.com/231-862/001-000)



**Item no.231-862/001-000/105-604**

THR male header; 1.2 x 1.2 mm solder pin; angled; Pin spacing 7.5 mm; 2-pole; black

[www.wago.com/231-862/001-000/105-604](http://www.wago.com/231-862/001-000/105-604)



**Item no.231-862/001-000/105-604/997-405**

THR male header; 1.2 x 1.2 mm solder pin; angled; in tape-and-reel packaging; Pin spacing 7.5 mm; 2-pole; black

[www.wago.com/231-862/001-000/105-604/997-405](http://www.wago.com/231-862/001-000/105-604/997-405)



**Item no.232-562/007-000**

Double pin header; DIN-35 rail mounting; 2-pole; Pin spacing 7.5 mm; gray

[www.wago.com/232-562/007-000](http://www.wago.com/232-562/007-000)



**Item no.731-602**

1-conductor male connector; CAGE CLAMP®; 2.5 mm²; Pin spacing 7.5 mm; 2-pole; 2,50 mm²; gray

[www.wago.com/731-602](http://www.wago.com/731-602)

**Item no.731-602/018-000**

Subject to changes. Please also observe the further product documentation!

WAGO GmbH & Co. KG

Hansastr. 27

32423 Minden

Phone: +49571 887-0 | Fax: +49571 887-169

Email: [info.de@wago.com](mailto:info.de@wago.com) | Web: [www.wago.com](http://www.wago.com)

Do you have any questions about our products?

We are always happy to take your call at +49 (571) 887-44222.



1-conductor male connector; CAGE CLAMP®; 2.5 mm²; Pin spacing 7.5 mm; 2-pole; DIN-35 rail /panel mounting; Snap-in mounting feet; 2,50 mm²; gray

[www.wago.com/731-602/018-000](http://www.wago.com/731-602/018-000)



**Item no. 731-602/114-000**

1-conductor male connector; CAGE CLAMP®; 2.5 mm²; Pin spacing 7.5 mm; 2-pole; Snap-in flange; 2,50 mm²; gray

[www.wago.com/731-602/114-000](http://www.wago.com/731-602/114-000)















**Item no. 731-602/019-000**

1-conductor male connector; CAGE CLAMP®; 2.5 mm²; Pin spacing 7.5 mm; 2-pole; clamping collar; 2,50 mm²; gray

[www.wago.com/731-602/019-000](http://www.wago.com/731-602/019-000)

## Optional accessories

### Ferrule

Ferrule		
	<b>Item no.: 216-101</b> Ferrule; Sleeve for 0.5 mm² / AWG 22; uninsulated; electro-tin plated; silver-colored	<a href="http://www.wago.com/216-101">www.wago.com/216-101</a>
	<b>Item no.: 216-104</b> Ferrule; Sleeve for 1.5 mm² / AWG 16; uninsulated; electro-tin plated; silver-colored	<a href="http://www.wago.com/216-104">www.wago.com/216-104</a>
	<b>Item no.: 216-106</b> Ferrule; Sleeve for 2.5 mm² / AWG 14; uninsulated; electro-tin plated; silver-colored	<a href="http://www.wago.com/216-106">www.wago.com/216-106</a>
	<b>Item no.: 216-102</b> Ferrule; Sleeve for 0.75 mm² / AWG 20; uninsulated; electro-tin plated; silver-colored	<a href="http://www.wago.com/216-102">www.wago.com/216-102</a>
	<b>Item no.: 216-103</b> Ferrule; Sleeve for 1 mm² / AWG 18; uninsulated; electro-tin plated	<a href="http://www.wago.com/216-103">www.wago.com/216-103</a>
	<b>Item no.: 216-123</b> Ferrule; Sleeve for 1 mm² / AWG 18; uninsulated; electro-tin plated; silver-colored	<a href="http://www.wago.com/216-123">www.wago.com/216-123</a>
	<b>Item no.: 216-122</b> Ferrule; Sleeve for 0.75 mm² / AWG 20; uninsulated; electro-tin plated; silver-colored	<a href="http://www.wago.com/216-122">www.wago.com/216-122</a>
	<b>Item no.: 216-124</b> Ferrule; Sleeve for 1.5 mm² / AWG 16; uninsulated; electro-tin plated	<a href="http://www.wago.com/216-124">www.wago.com/216-124</a>
	<b>Item no.: 216-142</b> Ferrule; Sleeve for 0.75 mm² / 18 AWG; uninsulated; electro-tin plated; electrolytic copper; gastight crimped; acc. to DIN 46228, Part 1/08.92	<a href="http://www.wago.com/216-142">www.wago.com/216-142</a>
	<b>Item no.: 216-132</b> Ferrule; Sleeve for 0.34 mm² / AWG 24; uninsulated; electro-tin plated	<a href="http://www.wago.com/216-132">www.wago.com/216-132</a>
	<b>Item no.: 216-121</b> Ferrule; Sleeve for 0.5 mm² / AWG 22; uninsulated; electro-tin plated; silver-colored	<a href="http://www.wago.com/216-121">www.wago.com/216-121</a>
	<b>Item no.: 216-143</b> Ferrule; Sleeve for 1 mm² / AWG 18; uninsulated; electro-tin plated; electrolytic copper; gastight	<a href="http://www.wago.com/216-143">www.wago.com/216-143</a>

Subject to changes. Please also observe the further product documentation!













crimped; acc. to DIN 46228, Part 1/08.92

	<b>Item no.: 216-131</b> Ferrule; Sleeve for 0.25 mm <sup>2</sup> / AWG 24; uninsulated; electro-tin plated; silver-colored	<a href="http://www.wago.com/216-131">www.wago.com/216-131</a>
	<b>Item no.: 216-141</b> Ferrule; Sleeve for 0.5 mm <sup>2</sup> / 20 AWG; uninsulated; electro-tin plated; electrolytic copper; gastight crimped; acc. to DIN 46228, Part 1/08.92	<a href="http://www.wago.com/216-141">www.wago.com/216-141</a>
	<b>Item no.: 216-152</b> Ferrule; Sleeve for 0.34 mm <sup>2</sup> / AWG 24; uninsulated; electro-tin plated	<a href="http://www.wago.com/216-152">www.wago.com/216-152</a>
	<b>Item no.: 216-203</b> Ferrule; Sleeve for 1 mm <sup>2</sup> / AWG 18; insulated; electro-tin plated; red	<a href="http://www.wago.com/216-203">www.wago.com/216-203</a>
	<b>Item no.: 216-202</b> Ferrule; Sleeve for 0.75 mm <sup>2</sup> / 18 AWG; insulated; electro-tin plated; gray	<a href="http://www.wago.com/216-202">www.wago.com/216-202</a>
	<b>Item no.: 216-151</b> Ferrule; Sleeve for 0.25 mm <sup>2</sup> / AWG 24; uninsulated; electro-tin plated	<a href="http://www.wago.com/216-151">www.wago.com/216-151</a>
	<b>Item no.: 216-204</b> Ferrule; Sleeve for 1.5 mm <sup>2</sup> / AWG 16; insulated; electro-tin plated; black	<a href="http://www.wago.com/216-204">www.wago.com/216-204</a>
	<b>Item no.: 216-144</b> Ferrule; Sleeve for 1.5 mm <sup>2</sup> / AWG 16; uninsulated; electro-tin plated; electrolytic copper; gastight crimped; acc. to DIN 46228, Part 1/08.92; silver-colored	<a href="http://www.wago.com/216-144">www.wago.com/216-144</a>
	<b>Item no.: 216-201</b> Ferrule; Sleeve for 0.5 mm <sup>2</sup> / 20 AWG; insulated; electro-tin plated; white	<a href="http://www.wago.com/216-201">www.wago.com/216-201</a>
	<b>Item no.: 216-223</b> Ferrule; Sleeve for 1 mm <sup>2</sup> / AWG 18; insulated; electro-tin plated; red	<a href="http://www.wago.com/216-223">www.wago.com/216-223</a>
	<b>Item no.: 216-241</b> Ferrule; Sleeve for 0.5 mm <sup>2</sup> / 20 AWG; insulated; electro-tin plated; electrolytic copper; gastight crimped; acc. to DIN 46228, Part 4/09.90; white	<a href="http://www.wago.com/216-241">www.wago.com/216-241</a>
	<b>Item no.: 216-242</b> Ferrule; Sleeve for 0.75 mm <sup>2</sup> / 18 AWG; insulated; electro-tin plated; electrolytic copper; gastight crimped; acc. to DIN 46228, Part 4/09.90; gray	<a href="http://www.wago.com/216-242">www.wago.com/216-242</a>
	<b>Item no.: 216-222</b> Ferrule; Sleeve for 0.75 mm <sup>2</sup> / 18 AWG; insulated; electro-tin plated; gray	<a href="http://www.wago.com/216-222">www.wago.com/216-222</a>
	<b>Item no.: 216-221</b> Ferrule; Sleeve for 0.5 mm <sup>2</sup> / 20 AWG; insulated; electro-tin plated; white	<a href="http://www.wago.com/216-221">www.wago.com/216-221</a>
	<b>Item no.: 216-224</b> Ferrule; Sleeve for 1.5 mm <sup>2</sup> / AWG 16; insulated; electro-tin plated; black	<a href="http://www.wago.com/216-224">www.wago.com/216-224</a>
	<b>Item no.: 216-243</b> Ferrule; Sleeve for 1 mm <sup>2</sup> / AWG 18; insulated; electro-tin plated; electrolytic copper; gastight crimped; acc. to DIN 46228, Part 4/09.90; red	<a href="http://www.wago.com/216-243">www.wago.com/216-243</a>
	<b>Item no.: 216-244</b> Ferrule; Sleeve for 1.5 mm <sup>2</sup> / AWG 16; insulated; electro-tin plated; electrolytic copper; gastight crimped; acc. to DIN 46228, Part 4/09.90; black	<a href="http://www.wago.com/216-244">www.wago.com/216-244</a>

Subject to changes. Please also observe the further product documentation!

	<b>Item no.: 216-263</b> Ferrule; Sleeve for 1 mm <sup>2</sup> / AWG 18; insulated; electro-tin plated; electrolytic copper; gastight crimped; acc. to DIN 46228, Part 4/09.90; red	<a href="http://www.wago.com/216-263">www.wago.com/216-263</a>
	<b>Item no.: 216-264</b> Ferrule; Sleeve for 1.5 mm <sup>2</sup> / AWG 16; insulated; electro-tin plated; electrolytic copper; gastight crimped; acc. to DIN 46228, Part 4/09.90; black	<a href="http://www.wago.com/216-264">www.wago.com/216-264</a>
	<b>Item no.: 216-284</b> Ferrule; Sleeve for 1.5 mm <sup>2</sup> / AWG 16; insulated; electro-tin plated; electrolytic copper; gastight crimped; acc. to DIN 46228, Part 4/09.90; black	<a href="http://www.wago.com/216-284">www.wago.com/216-284</a>
	<b>Item no.: 216-262</b> Ferrule; Sleeve for 0.75 mm <sup>2</sup> / 18 AWG; insulated; electro-tin plated; electrolytic copper; gastight crimped; acc. to DIN 46228, Part 4/09.90; gray	<a href="http://www.wago.com/216-262">www.wago.com/216-262</a>
	<b>Item no.: 216-301</b> Ferrule; Sleeve for 0.25 mm <sup>2</sup> / AWG 24; insulated; electro-tin plated; yellow	<a href="http://www.wago.com/216-301">www.wago.com/216-301</a>
	<b>Item no.: 216-321</b> Ferrule; Sleeve for 0.25 mm <sup>2</sup> / AWG 24; insulated; electro-tin plated; yellow	<a href="http://www.wago.com/216-321">www.wago.com/216-321</a>
	<b>Item no.: 216-322</b> Ferrule; Sleeve for 0.34 mm <sup>2</sup> / 22 AWG; insulated; electro-tin plated; light turquoise	<a href="http://www.wago.com/216-322">www.wago.com/216-322</a>
	<b>Item no.: 216-302</b> Ferrule; Sleeve for 0.34 mm <sup>2</sup> / 22 AWG; insulated; electro-tin plated; light turquoise	<a href="http://www.wago.com/216-302">www.wago.com/216-302</a>

#### Strain relief

Strain relief housing



<b>Item no.: 232-662</b> Strain relief housing; for female and male connectors; 2 parts; Pin spacing 7.5 mm; 2-pole; gray	<a href="http://www.wago.com/232-662">www.wago.com/232-662</a>
--	--

#### Testing and measuring

Testing accessories



<b>Item no.: 210-136</b> Test plug; 2 mm Ø; with 500 mm cable; red	<a href="http://www.wago.com/210-136">www.wago.com/210-136</a>
---	--



<b>Item no.: 231-662</b> Test plugs for female connectors; for 7.5 mm and 7.62 mm pin spacing; 2,50 mm <sup>2</sup> ; light gray	<a href="http://www.wago.com/231-662">www.wago.com/231-662</a>
---	--

#### Insulation stop

Insulation stop



<b>Item no.: 231-673</b> Insulation stop; 0.08-0.2 mm <sup>2</sup> / 0.2 mm <sup>2</sup> "s"; white	<a href="http://www.wago.com/231-673">www.wago.com/231-673</a>
--	--



<b>Item no.: 231-674</b> Insulation stop; 0.25 - 0.5 mm <sup>2</sup> ; light gray	<a href="http://www.wago.com/231-674">www.wago.com/231-674</a>
--	--

Subject to changes. Please also observe the further product documentation!



**Item no.: 231-675**  
Insulation stop; 0.75 - 1 mm<sup>2</sup>; dark gray

[www.wago.com/231-675](http://www.wago.com/231-675)

## Cover

Cover



**Item no.: 231-668**  
Lockout caps; for covering unused clamping units; gray

[www.wago.com/231-668](http://www.wago.com/231-668)

## Marking accessories

Marking strip



**Item no.: 210-331/750-202**  
Marking strips; as a DIN A4 sheet; MARKED; 1-16 (100x); Height of marker strip: 2.3 mm/0.091 in; Strip length 182 mm; Horizontal marking; Self-adhesive; white

[www.wago.com/210-331/750-202](http://www.wago.com/210-331/750-202)



**Item no.: 210-332/750-020**  
Marking strips; as a DIN A4 sheet; MARKED; 1-20 (80x); Height of marker strip: 3 mm; Strip length 182 mm; Horizontal marking; Self-adhesive; white

[www.wago.com/210-332/750-020](http://www.wago.com/210-332/750-020)

## Tool

Operating tool



**Item no.: 210-657**  
Operating tool; Blade: 3.5 x 0.5 mm; with a partially insulated shaft; short; multicoloured

[www.wago.com/210-657](http://www.wago.com/210-657)



**Item no.: 210-720**  
Operating tool; Blade: 3.5 x 0.5 mm; with a partially insulated shaft; multicoloured

[www.wago.com/210-720](http://www.wago.com/210-720)



**Item no.: 231-131**  
Operating tool; made of insulating material; 1-way; loose; white

[www.wago.com/231-131](http://www.wago.com/231-131)



**Item no.: 231-291**  
Operating tool; made of insulating material; 1-way; loose; red

[www.wago.com/231-291](http://www.wago.com/231-291)

## Downloads

### Documentation

#### Additional Information

Technical Section	2019 Apr 3	pdf	Download
Technical explanations		2.0 MB	

Subject to changes. Please also observe the further product documentation!

## CAD/CAE-Data

### CAD data

2D/3D Models 231-202/026-000	<a href="#">URL</a>	<a href="#">Download</a>
------------------------------	---------------------	--------------------------

### CAE data

EPLAN Data Portal 231-202/026-000	<a href="#">URL</a>	<a href="#">Download</a>
-----------------------------------	---------------------	--------------------------

EPLAN Data Portal 231-202/026-000	<a href="#">URL</a>	<a href="#">Download</a>
-----------------------------------	---------------------	--------------------------

ZUKEN Portal 231-202/026-000	<a href="#">URL</a>	<a href="#">Download</a>
------------------------------	---------------------	--------------------------

## Environmental Product Compliance

### Compliance Search

Environmental Product Compliance 231-202/026-000	<a href="#">URL</a>	<a href="#">Download</a>
--	---------------------	--------------------------

1-conductor female connector; CAGE CLAMP®; 2.5 mm<sup>2</sup>; Pin spacing 7.5 mm; 2-pole; 2,50 mm<sup>2</sup>; gray

## Installation Notes

### Conductor termination

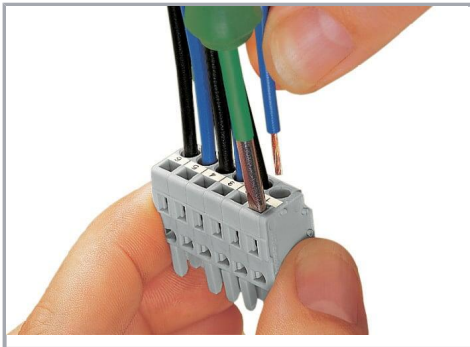

Inserting a conductor via 3.5 mm screwdriver – CAGE CLAMP® actuation parallel to conductor entry.

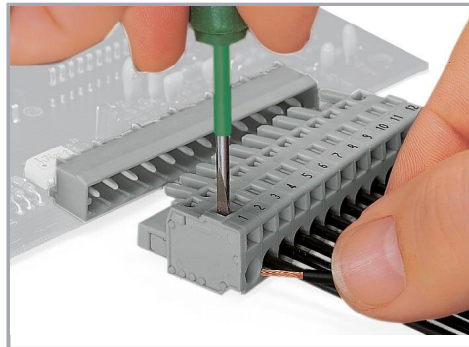

Inserting a conductor via 3.5 mm screwdriver – CAGE CLAMP® actuation perpendicular to conductor entry.

Subject to changes. Please also observe the further product documentation!



Inserting a conductor into CAGE CLAMP® unit via operating tool (231-291).



Inserting a conductor via operating tool.

### Coding



Coding a female connector by removing coding finger(s).

### Testing

Subject to changes. Please also observe the further product documentation!



Testing – female connector with CAGE CLAMP®

Integrated test ports for testing perpendicular to conductor entry via 2 or 2.3 mm Ø test plug

### Installation



Male connector with strain relief plate



Strain relief housing shown with a male connector equipped with CAGE CLAMP®

### Marking

Subject to changes. Please also observe the further product documentation!



Labeling via direct marking or self-adhesive strips.

## Product family

**MCS MIDI Classic**

[Show all products from the family](#)

Subject to changes. Please also observe the further product documentation!