

# SCR

<b>C11 SERIES</b>
<b>2N1770-78,</b>
<b>2N2619</b>

The C11 Silicon Controlled Rectifier is a three junction semiconductor device for use in low power switching and control applications requiring blocking voltages up to 600 volts and RMS load currents up to 7.4 amperes.

- Broad Voltage Range (Up to 600V)
- Long Electrical Creepage Path
- Over Three Years of Successful Field Experience
- No Gate Bias Required
- High Gate Sensitivity

**SOLID STATE INC.**  
46 FARRAND STREET  
BLOOMFIELD, NEW JERSEY 07003

www.solidstateinc.com

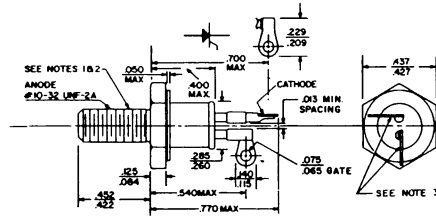
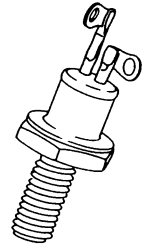

- NOTES: 1. COMPLETE THREADS EXTEND TO WITHIN 2-1/2 THREADS OF HEAD.  
2. DIAMETER OF UNTHREADED PORTION .180 MAX.  
3. ANGULAR ORIENTATION OF THESE TERMINALS IS UNDEFINED.  
4. CASE IS ANODE CONNECTION.  
5. ALL DIMENSIONS IN INCHES.

Type	Minimum Forward Breakover Voltage (V <sub>BO</sub> )† T <sub>J</sub> = -65°C to +125°C	Repetitive Peak Reverse Voltage (PRV)† T <sub>J</sub> = -65°C to +125°C	Transient Peak Reverse Voltage (Non-recurrent < 5 Millisec.)† T <sub>J</sub> = -65°C to +125°C
C11U (2N1770)	25 Volts*	25 Volts*	40 Volts*
C11F (2N1771)	50 Volts*	50 Volts*	75 Volts*
C11A (2N1772)	100 Volts*	100 Volts*	150 Volts*
C11G (2N1773)	150 Volts*	150 Volts*	225 Volts*
C11B (2N1774)	200 Volts*	200 Volts*	300 Volts*
C11H (2N1775)	250 Volts*	250 Volts*	350 Volts*
C11C (2N1776)	300 Volts*	300 Volts*	400 Volts*
C11D (2N1777)	400 Volts*	400 Volts*	500 Volts*
C11E (2N1778)	500 Volts*	500 Volts*	600 Volts*
C11M (2N2619)	600 Volts*	600 Volts*	720 Volts*

†Values apply for zero or negative gate voltage only. Maximum case to ambient thermal resistance for which maximum PRV ratings apply equals 18°C/watt.

### MAXIMUM ALLOWABLE RATINGS

Repetitive Peak Forward Blocking Voltage (PFV)	(C11U thru C11D)	480	Volts
	(C11E and C11M)	720	Volts
RMS Forward Current	(All conduction angles)	7.4	Amperes
Average Forward Current (I <sub>o</sub> )	4.7 Amperes* at 60°C Case (Half Wave Rectified)		
	For other operating conditions see Chart 3.		
Peak One Cycle Non-recurrent Surge Current (i <sub>surge</sub> )		60	Amperes*
Peak Surge Current During Turn-on Time Interval			See Chart 7
I <sup>2</sup> t (for fusing)			Calculate from Chart 8
Peak Gate Power (p <sub>G</sub> )		5	Watts*
Average Gate Power (P <sub>G</sub> )		0.5	Watt*
** Peak Gate Current (i <sub>G</sub> )		2.0	Amperes*
Peak Gate Voltage (v <sub>G</sub> ) (Forward and Reverse)		10	Volts*
Operating Temperature		-65°C to +125°C*	
Storage Temperature		-65°C to +150°C*	
Stud Torque		15	inch-pounds

\*Indicates data included on JEDEC type number registration.

\*\*NOT TO EXCEED GATE POWER RATINGS

# CHARACTERISTICS

C11 SERIES

2N1770-78

2N2619

Test	Symbol	Min.	Typ.	Max.	Units	Test Conditions
Peak Reverse and Forward Blocking Current† C11U (2N1770) C11F (2N1771) C11A (2N1772) C11G (2N1773) C11B (2N1774) C11H (2N1775) C11C (2N1776) C11D (2N1777) C11E (2N1778) C11M (2N2619)	$i_R$ and $i_S$	—	4.5	9.0	ma	$T_J = 125^\circ\text{C}$ , Gate Open $v_{AC} = v_{CA} = 25$ Volts Peak
Full Cycle Avg. Reverse and Forward Blocking Current† C11U (2N1770) C11F (2N1771) C11A (2N1772) C11G (2N1773) C11B (2N1774) C11H (2N1775) C11C (2N1776) C11D (2N1777) C11E (2N1778) C11M (2N2619)	$I_{R(AV)}$ and $I_{S(AV)}$	—	2.3	4.5*	mAdc	$T_J = 60^\circ\text{C}$ , $I_o = 4.7\text{A}$ , half sine wave 180° Conduction Angle $v_{AC} = v_{CA} = 25$ Volts Peak
Gate Current to Fire	$I_{GF}$	—	10	15	mAdc	$V_{AC} = 12\text{Vdc}$ , $T_J = 25^\circ\text{C}$ , $R_L = 250$ ohms
		—	20	30*	mAdc	$V_{AC} = 12\text{Vdc}$ , $T_J = -65^\circ\text{C}$ , $R_L = 250$ ohms
		—	4	8	mAdc	$V_{AC} = 12\text{Vdc}$ , $T_J = 125^\circ\text{C}$ , $R_L = 250$ ohms
Gate Voltage to Fire	$V_{GF}$	—	1.3	2.0*	Vdc	$V_{AC} = 12\text{Vdc}$ , $T_J = -65^\circ$ to $+125^\circ\text{C}$ , $R_L = 250$ ohms
		0.3*	0.7	—	Vdc	$v_{AC} = \text{Rated}$ , $T_J = 125^\circ\text{C}$ , $R_L = 250$ ohms
Peak Forward Voltage Drop	$v_F$	—	1.6	1.85	v	$T_J = 25^\circ\text{C}$ , $i_F = 15$ a (single sinusoidal pulse, 4 ms wide)
Holding Current	$I_H$	—	8.0	—	mAdc	Anode Supply = 6 Vdc, $T_J = 25^\circ\text{C}$
Turn-on Time	$t_{on} + t_r$	—	1.0	—	$\mu\text{sec}$	$T_J = 25^\circ\text{C}$ , $i_F = 10$ a, $v_{AC} = \text{Rated Gate Supply}$ : 7 volt open circuit, 20 ohm, 0.1 $\mu\text{sec}$ max. rise time.
Turn-off Time	$t_{off}$	—	15	—	$\mu\text{sec}$	$T_J = 125^\circ\text{C}$ , $i_F = 5$ a, $i_R = 5$ a $v_{AC}$ (Reapplied) = Rated. Rate of Rise of Reapplied Forward Blocking Voltage = 20 volts per microsecond maximum.
Thermal Resistance	$\theta_{J-C}$	—	1.5	3.1	$^\circ\text{C/Watt}$	Junction to Case.

†Values apply for zero or negative gate voltage. Maximum case to ambient thermal resistance for which maximum PRV ratings apply = 18°C per watt.

\*Indicates data included on JEDEC type number registration.

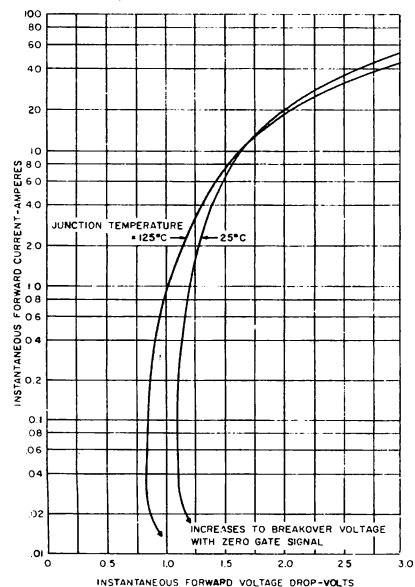

**1. MAXIMUM FORWARD CHARACTERISTICS  
CONDUCTING STATE**

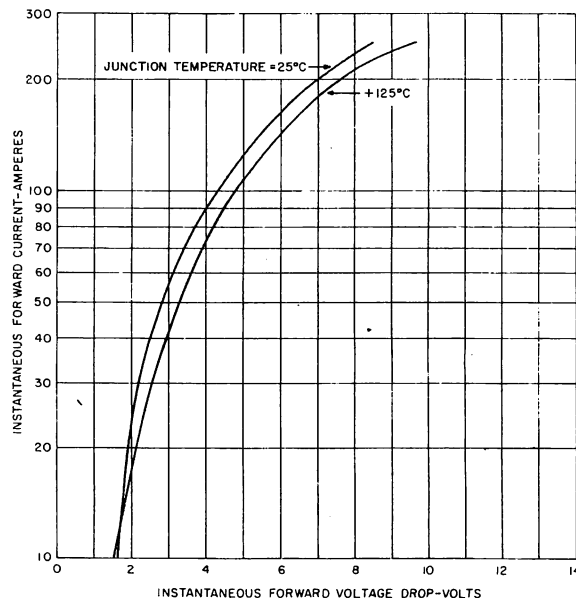

**2. MAXIMUM FORWARD CHARACTERISTICS  
HIGH CURRENT LEVEL — CONDUCTING STATE**

C11 SERIES
2N1770-78
2N2619

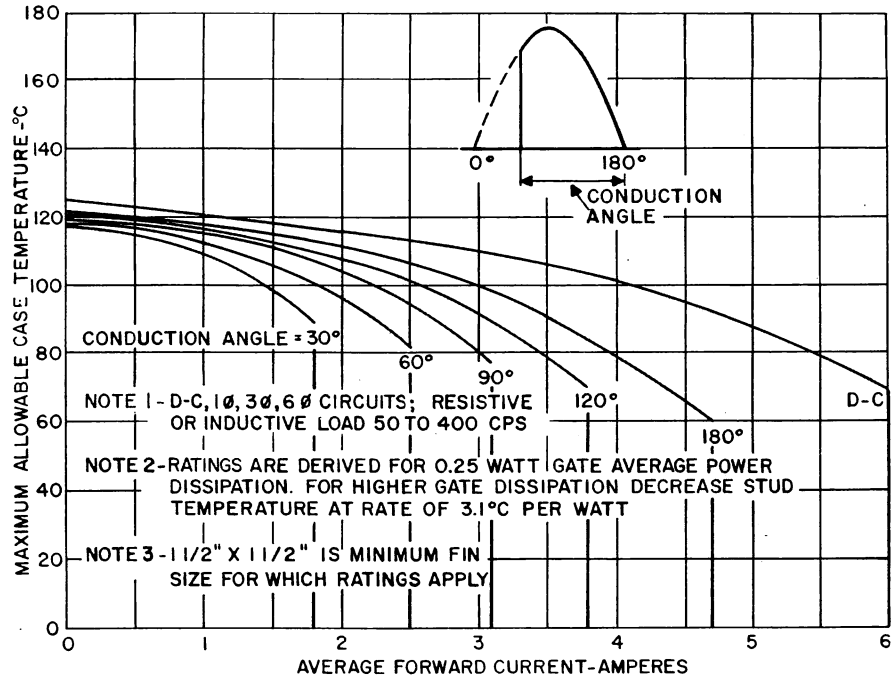

3. MAXIMUM ALLOWABLE CASE TEMPERATURE

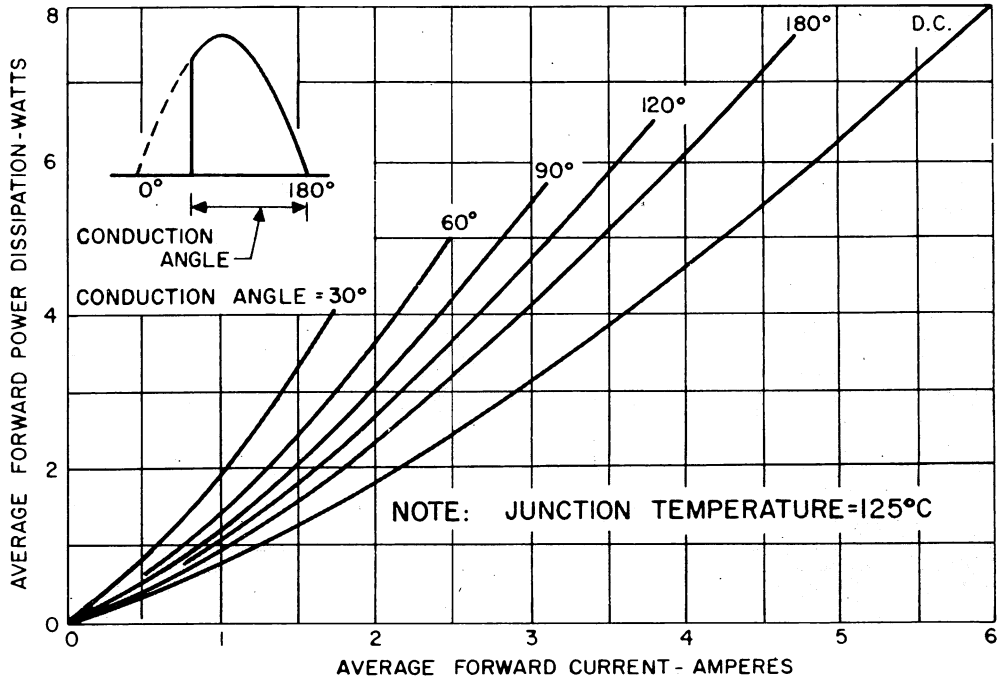

4. FORWARD POWER DISSIPATION

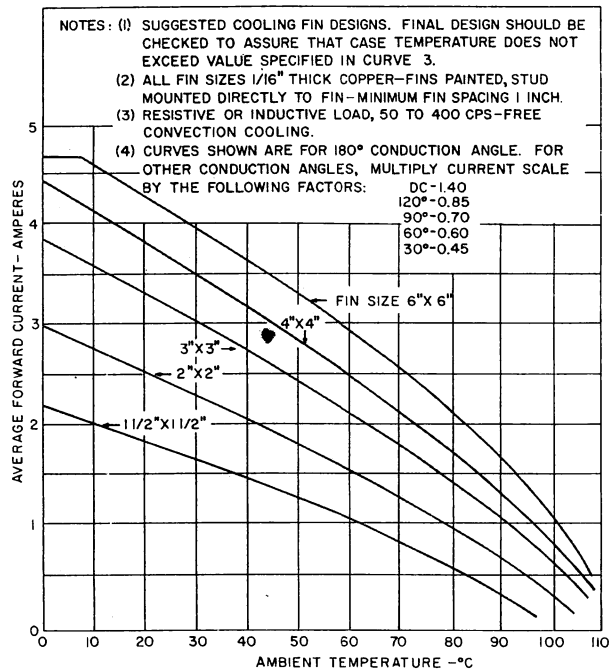

5. MAXIMUM FORWARD CURRENT VS. AMBIENT TEMPERATURE FOR VARIOUS FIN SIZES

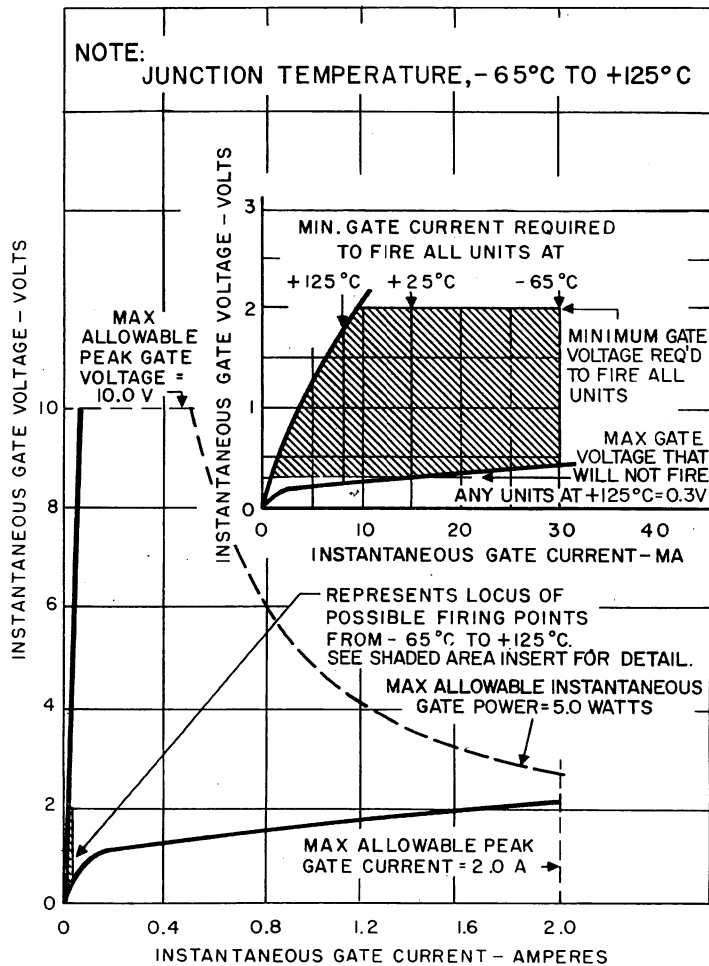

6. FIRING CHARACTERISTICS

C11 SERIES

2N1770-78

2N2619

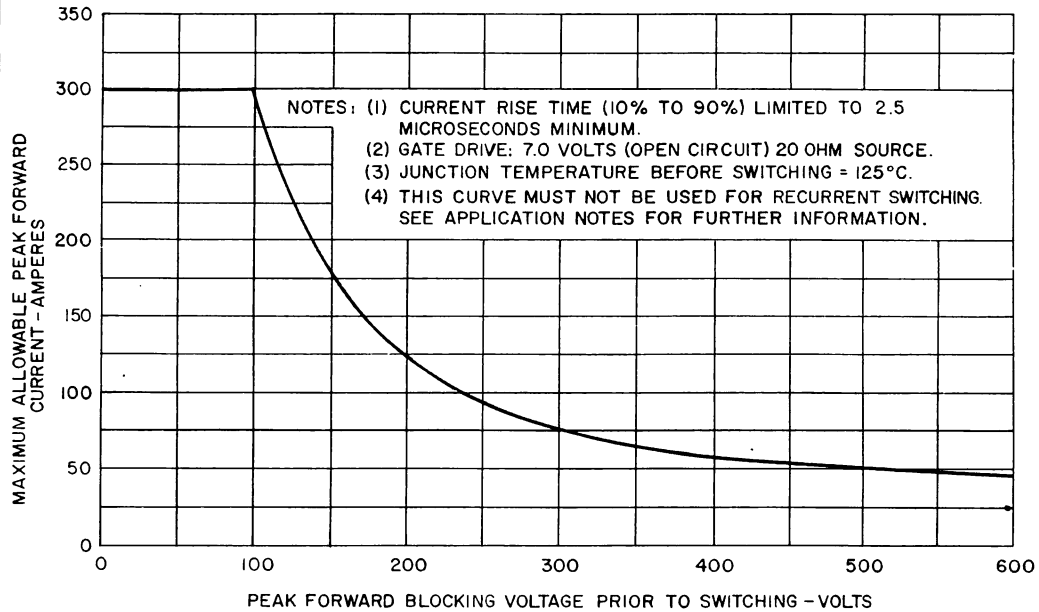

7. PEAK NON-RECURRENT SURGE CURRENT DURING TURN-ON TIME INTERVAL

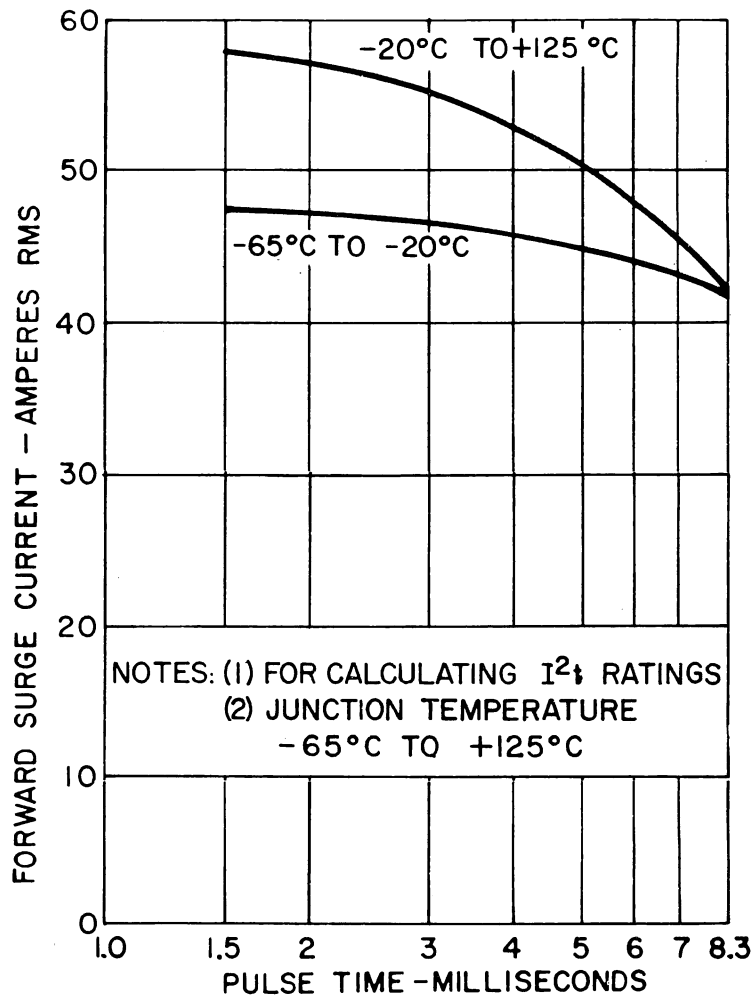

8. MAXIMUM ALLOWABLE NON-RECURRENT SUB-CYCLE SURGE CURRENT RATING

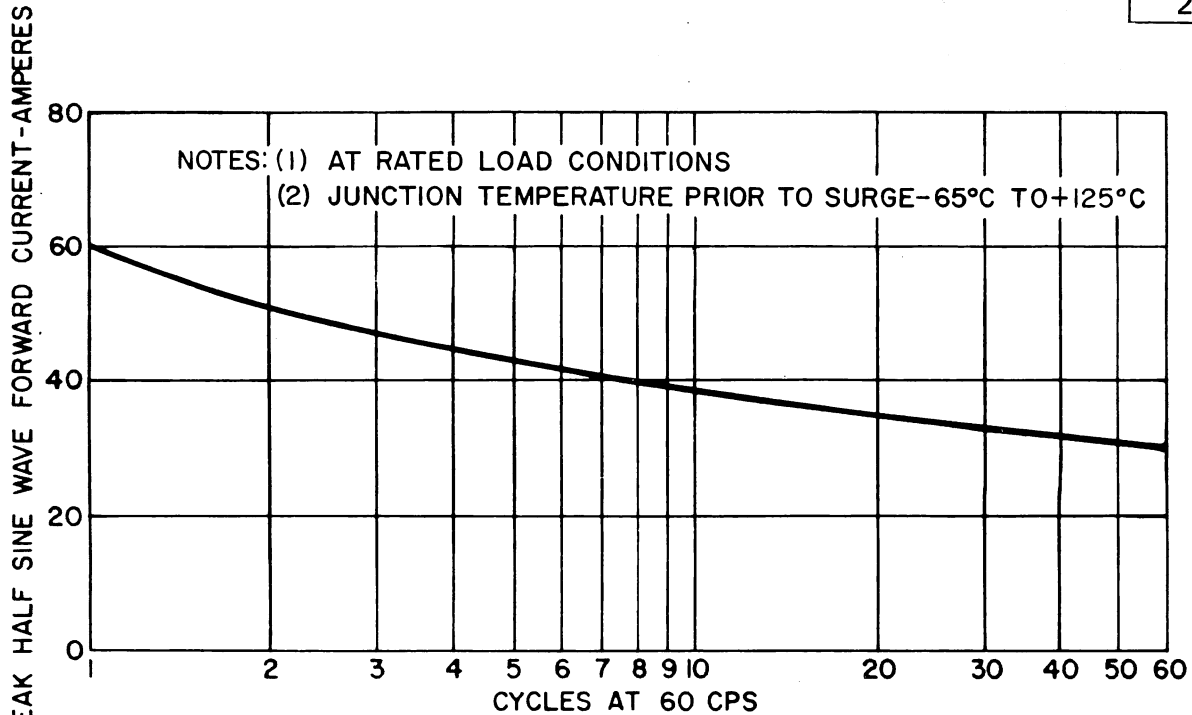

9. MAXIMUM ALLOWABLE NON-RECURRENT SURGE CURRENT RATING

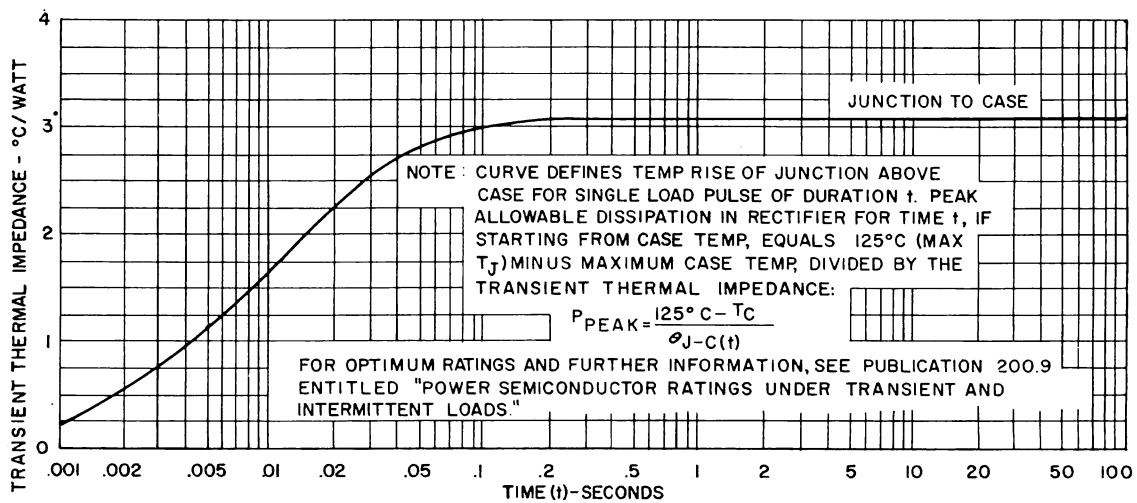

10. MAXIMUM TRANSIENT THERMAL RESISTANCE

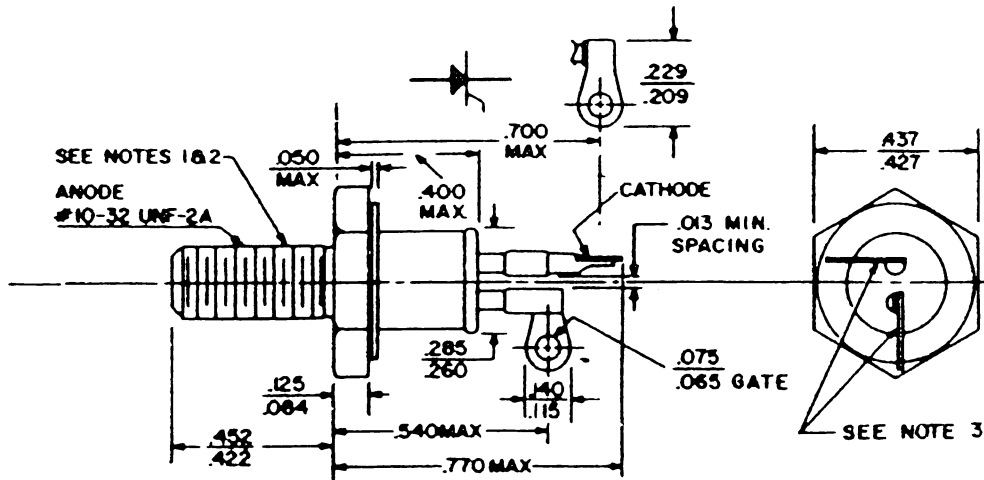
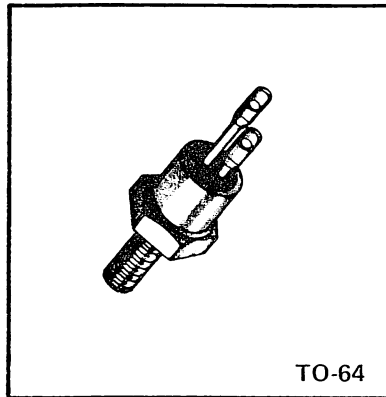

- NOTES : 1. COMPLETE THREADS EXTEND TO WITHIN 2-1/2 THREADS OF HEAD.
2. DIAMETER OF UNTHREADED PORTION .190 MAX.
3. ANGULAR ORIENTATION OF THESE TERMINALS IS UNDEFINED.
4. CASE IS ANODE CONNECTION.
5. ALL DIMENSIONS IN INCHES.