

# NID5004N

## Self-Protected FET with Temperature and Current Limit

40 V, 6.5 A, Single N-Channel, DPAK

Self-protected FETs are a series of power MOSFETs which utilize ON Semiconductor HDPlus™ technology. The self-protected MOSFET incorporates protection features such as integrated thermal and current limits. The self-protected MOSFETs include an integrated Drain-to-Gate Clamp that provides overvoltage protection from transients and avalanche. The device is protected from Electrostatic Discharge (ESD) by utilizing an integrated Gate-to-Source Clamp.

### Features

- Short Circuit Protection
- In Rush Current Limit
- Thermal Shutdown with Automatic Restart
- Avalanche Rated
- Overvoltage Protection
- ESD Protection (4 kV HBM)
- Controlled Slew Rate for Low Noise Switching
- AEC Q101 Qualified
- This is a Pb-Free Device

### Applications

- Solenoid Driver
- Relay Driver
- Small Motors
- Lighting
- Relay Replacement
- Load Switching



ON Semiconductor®

<http://onsemi.com>

V <sub>DSS</sub> (Clamped)	R <sub>DS(on)</sub> Typ	I <sub>D</sub> Typ (Limited)
40 V	110 mΩ @ 10 V	6.5 A

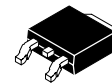
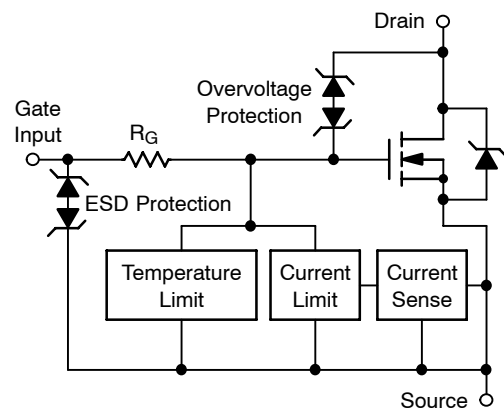

DPAK  
CASE 369C  
STYLE 2

### MARKING DIAGRAM

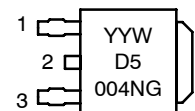

D5004N = Device Code  
Y = Year  
WW = Work Week  
G = Pb-Free Device

1 = Gate  
2 = Drain  
3 = Source

### ORDERING INFORMATION

Device	Package	Shipping†
NID5004NT4G	DPAK (Pb-Free)	2500/Tape & Reel

†For information on tape and reel specifications, including part orientation and tape sizes, please refer to our Tape and Reel Packaging Specification Brochure, BRD8011/D.

# NID5004N

## MOSFET MAXIMUM RATINGS ( $T_J = 25^\circ\text{C}$ unless otherwise noted)

Rating	Symbol	Value	Unit
Drain-to-Source Voltage Internally Clamped	$V_{DSS}$	44	Vdc
Gate-to-Source Voltage	$V_{GS}$	$\pm 14$	Vdc
Drain Current Continuous	$I_D$	Internally Limited	
Total Power Dissipation @ $T_A = 25^\circ\text{C}$ (Note 1) @ $T_A = 25^\circ\text{C}$ (Note 2)	$P_D$	1.3 2.5	W
Thermal Resistance Junction-to-Case Junction-to-Ambient (Note 1) Junction-to-Ambient (Note 2)	$R_{\theta JC}$ $R_{\theta JA}$ $R_{\theta JA}$	3.0 95 50	$^\circ\text{C/W}$
Single Pulse Drain-to-Source Avalanche Energy ( $V_{DD} = 30\text{ Vdc}$ , $V_{GS} = 5.0\text{ Vdc}$ , $I_L = 1.8\text{ Apk}$ , $L = 160\text{ mH}$ , $R_G = 25\ \Omega$ ) (Note 3)	$E_{AS}$	273	mJ
Operating and Storage Temperature Range (Note 4)	$T_J, T_{stg}$	-55 to 150	$^\circ\text{C}$

Stresses exceeding Maximum Ratings may damage the device. Maximum Ratings are stress ratings only. Functional operation above the Recommended Operating Conditions is not implied. Extended exposure to stresses above the Recommended Operating Conditions may affect device reliability.

1. Surface mounted onto minimum pad size (100 sq/mm) FR4 PCB, 1 oz cu.
2. Mounted onto 1" square pad size (700 sq/mm) FR4 PCB, 1 oz cu.
3. Not subject to Production Test
4. Normal pre-fault operating range. See thermal limit range conditions.

# NID5004N

## MOSFET ELECTRICAL CHARACTERISTICS ( $T_J = 25^\circ\text{C}$ unless otherwise noted)

Characteristic	Symbol	Min	Typ	Max	Unit
<b>OFF CHARACTERISTICS</b>					
Drain-to-Source Clamped Breakdown Voltage ( $V_{GS} = 0\text{ V}$ , $I_D = 2\text{ mA}$ )	$V_{(BR)DSS}$	36	40	44	V
Zero Gate Voltage Drain Current ( $V_{DS} = 32\text{ V}$ , $V_{GS} = 0\text{ V}$ )	$I_{DSS}$	-	27	100	$\mu\text{A}$
Gate Input Current ( $V_{GS} = 5.0\text{ V}$ , $V_{DS} = 0\text{ V}$ )	$I_{GSS}$	-	45	200	$\mu\text{A}$

## ON CHARACTERISTICS

Gate Threshold Voltage ( $V_{DS} = V_{GS}$ , $I_D = 150\ \mu\text{A}$ ) Threshold Temperature Coefficient	$V_{GS(th)}$	1.0 -	1.85 5.0	2.2 -	V -mV/ $^\circ\text{C}$
Static Drain-to-Source On-Resistance (Note 5) ( $V_{GS} = 10\text{ V}$ , $I_D = 2.0\text{ A}$ , $T_J @ 25^\circ\text{C}$ )	$R_{DS(on)}$	-	110	130	m $\Omega$
Static Drain-to-Source On-Resistance (Note 5) ( $V_{GS} = 5.0\text{ V}$ , $I_D = 2.0\text{ A}$ , $T_J @ 25^\circ\text{C}$ ) ( $V_{GS} = 5.0\text{ V}$ , $I_D = 2.0\text{ A}$ , $T_J @ 150^\circ\text{C}$ )	$R_{DS(on)}$	- -	130 240	150 270	m $\Omega$
Source-Drain Forward On Voltage ( $I_S = 7.0\text{ A}$ , $V_{GS} = 0\text{ V}$ )	$V_{SD}$	-	0.9	1.1	V

## SWITCHING CHARACTERISTICS (Note 6)

Turn-on Delay Time	$R_L = 6.6\ \Omega$ , $V_{in} = 0\text{ to }10\text{ V}$ , $V_{DD} = 13.8\text{ V}$ , $I_D = 2.0\text{ A}$ , 10% $V_{in}$ to 10% $I_D$	$t_{d(on)}$	-	97	115	ns
Turn-on Rise Time	$R_L = 6.6\ \Omega$ , $V_{in} = 0\text{ to }10\text{ V}$ , $V_{DD} = 13.8\text{ V}$ , $I_D = 2.0\text{ A}$ , 10% $I_D$ to 90% $I_D$	$t_{rise}$	-	282	300	ns
Turn-off Delay Time	$R_L = 6.6\ \Omega$ , $V_{in} = 0\text{ to }10\text{ V}$ , $V_{DD} = 13.8\text{ V}$ , $I_D = 2.0\text{ A}$ , 90% $V_{in}$ to 90% $I_D$	$t_{d(off)}$	-	930	1020	ns
Turn-off Fall Time	$R_L = 6.6\ \Omega$ , $V_{in} = 0\text{ to }10\text{ V}$ , $V_{DD} = 13.8\text{ V}$ , $I_D = 2.0\text{ A}$ , 90% $I_D$ to 10% $I_D$	$t_{fall}$	-	690	750	ns
Slew Rate ON	$R_L = 6.6\ \Omega$ , $V_{in} = 0\text{ to }10\text{ V}$ , $V_{DD} = 13.8\text{ V}$ , $I_D = 2.0\text{ A}$ , 70% to 50% $V_{DD}$	$dV_{DS}/dT_{on}$	-	64	-	V/ $\mu\text{s}$
Slew Rate OFF	$R_L = 6.6\ \Omega$ , $V_{in} = 0\text{ to }10\text{ V}$ , $V_{DD} = 13.8\text{ V}$ , $I_D = 2.0\text{ A}$ , 50% to 70% $V_{DD}$	$dV_{DS}/dT_{off}$	-	28	-	V/ $\mu\text{s}$

## SELF PROTECTION CHARACTERISTICS ( $T_J = 25^\circ\text{C}$ unless otherwise noted) (Note 7)

Current Limit	$V_{DS} = 10\text{ V}$ , $V_{GS} = 5.0\text{ V}$ , $T_J = 25^\circ\text{C}$ (Note 8) $V_{DS} = 10\text{ V}$ , $V_{GS} = 5.0\text{ V}$ , $T_J = 100^\circ\text{C}$ (Note 6, 8) $V_{DS} = 10\text{ V}$ , $V_{GS} = 10\text{ V}$ , $T_J = 25^\circ\text{C}$ (Note 6, 8)	$I_{LIM}$	4.0 4.0 -	6.5 5.5 7.9	11 11 -	A
Temperature Limit (Turn-off)	$V_{GS} = 5.0\text{ V}$ (Note 6)	$T_{LIM(off)}$	150	180	200	$^\circ\text{C}$
Thermal Hysteresis	$V_{GS} = 5.0\text{ V}$	$\Delta T_{LIM(on)}$	-	10	-	$^\circ\text{C}$
Temperature Limit (Turn-off)	$V_{GS} = 10\text{ V}$ (Note 6)	$T_{LIM(off)}$	150	180	200	$^\circ\text{C}$
Thermal Hysteresis	$V_{GS} = 10\text{ V}$	$\Delta T_{LIM(on)}$	-	20	-	$^\circ\text{C}$
Input Current during Thermal Fault	$V_{DS} = 0\text{ V}$ , $V_{GS} = 5.0\text{ V}$ , $T_J = T_J > T_{(fault)}$ (Note 6) $V_{DS} = 0\text{ V}$ , $V_{GS} = 10\text{ V}$ , $T_J = T_J > T_{(fault)}$ (Note 6)	$I_{g(fault)}$	5.5 12	5.2 11	-	mA

## ESD ELECTRICAL CHARACTERISTICS ( $T_J = 25^\circ\text{C}$ unless otherwise noted)

Electrostatic Discharge Capability Human Body Model (HBM) Machine Model (MM) (Note 6)	ESD	4000 400	- -	- -	V
---	-----	-------------	--------	--------	---

5. Pulse Test: Pulse Width  $\leq 300\ \mu\text{s}$ , Duty Cycle  $\leq 2\%$ .
6. Not subject to Production Test
7. Fault conditions are viewed as beyond the normal operating range of the part.
8. Current limit measured at  $380\ \mu\text{s}$  after gate pulse.

TYPICAL PERFORMANCE CURVES

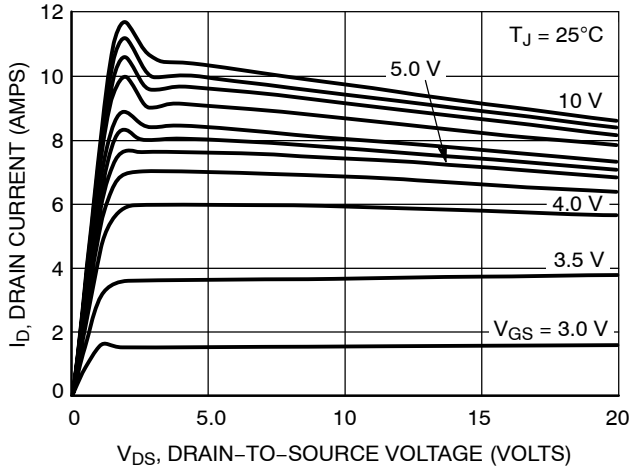

Figure 1. On-Region Characteristics

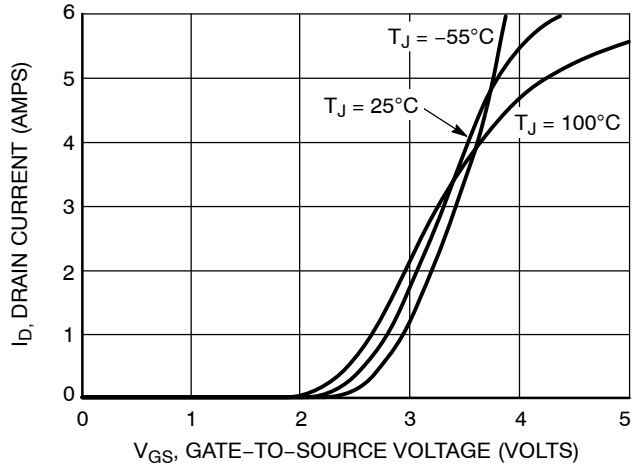

Figure 2. Transfer Characteristics

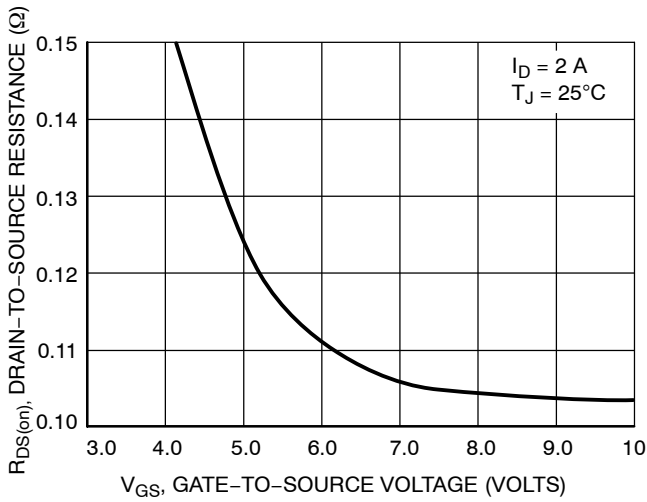

Figure 3. On-Resistance vs. Gate-to-Source Voltage

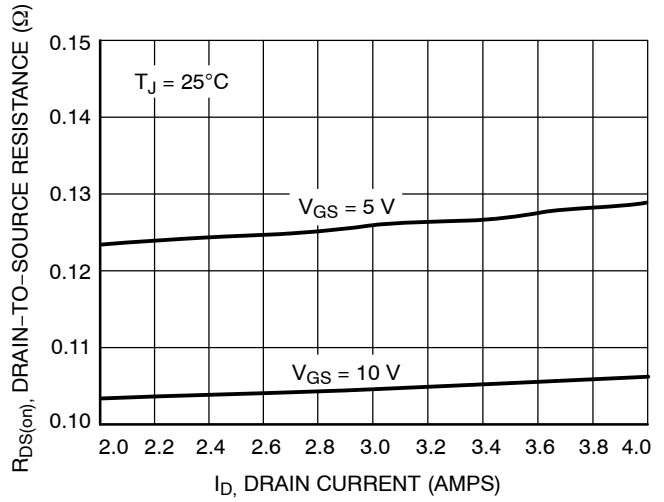

Figure 4. On-Resistance vs. Drain Current

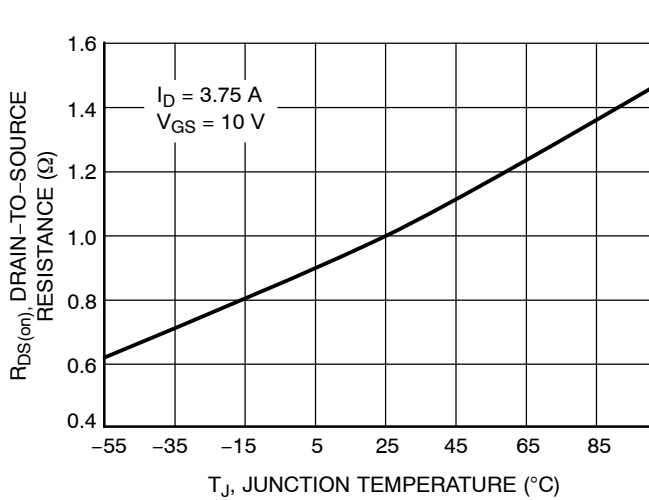

Figure 5. On-Resistance Variation with Temperature

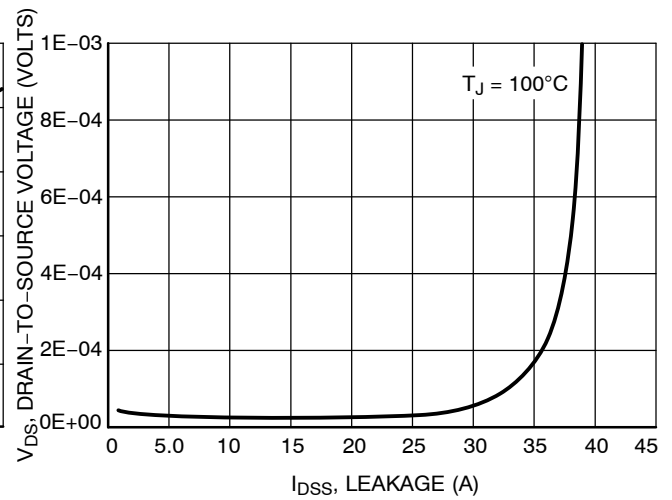

Figure 6. Drain-to-Source Leakage Current vs. Voltage

# NID5004N

## z TYPICAL PERFORMANCE CURVES

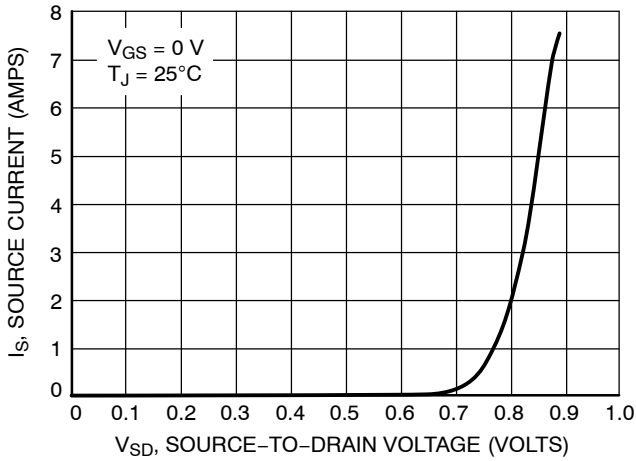

Figure 7. Diode Forward Voltage vs. Current

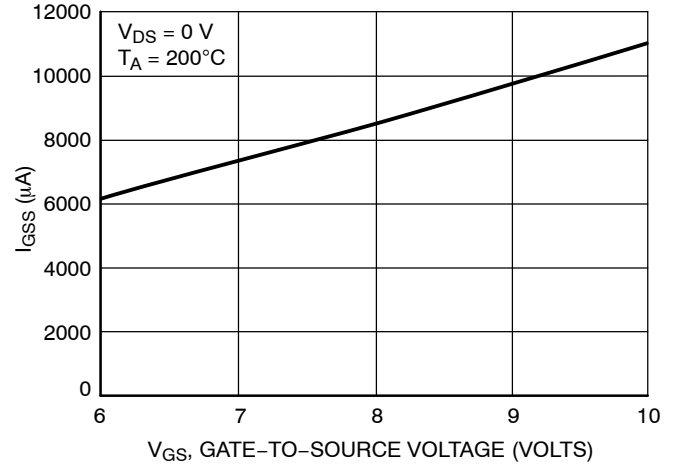

Figure 8. Input Current vs. Gate Voltage

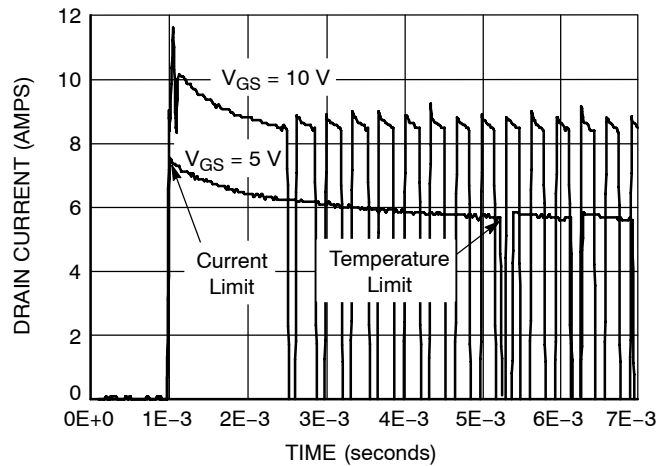

Figure 9. Short Circuit Response\*

\*(Actual thermal cycling response in short circuit dependent on device power level, thermal mounting, and ambient temperature conditions)

# MECHANICAL CASE OUTLINE

## PACKAGE DIMENSIONS

ON Semiconductor®



SCALE 1:1

### DPAK (SINGLE GAUGE)

#### CASE 369C

#### ISSUE F

DATE 21 JUL 2015



NOTES:

1. DIMENSIONING AND TOLERANCING PER ASME Y14.5M, 1994.
2. CONTROLLING DIMENSION: INCHES.
3. THERMAL PAD CONTOUR OPTIONAL WITHIN DIMENSIONS b3, L3 and Z.
4. DIMENSIONS D AND E DO NOT INCLUDE MOLD FLASH, PROTRUSIONS, OR BURRS. MOLD FLASH, PROTRUSIONS, OR GATE BURRS SHALL NOT EXCEED 0.006 INCHES PER SIDE.
5. DIMENSIONS D AND E ARE DETERMINED AT THE OUTERMOST EXTREMES OF THE PLASTIC BODY.
6. DATUMS A AND B ARE DETERMINED AT DATUM PLANE H.
7. OPTIONAL MOLD FEATURE.

DIM	INCHES		MILLIMETERS	
	MIN	MAX	MIN	MAX
A	0.086	0.094	2.18	2.38
A1	0.000	0.005	0.00	0.13
b	0.025	0.035	0.63	0.89
b2	0.028	0.045	0.72	1.14
b3	0.180	0.215	4.57	5.46
c	0.018	0.024	0.46	0.61
c2	0.018	0.024	0.46	0.61
D	0.235	0.245	5.97	6.22
E	0.250	0.265	6.35	6.73
e	0.090 BSC		2.29 BSC	
H	0.370	0.410	9.40	10.41
L	0.055	0.070	1.40	1.78
L1	0.114 REF		2.90 REF	
L2	0.020 BSC		0.51 BSC	
L3	0.035	0.050	0.89	1.27
L4	---	0.040	---	1.01
Z	0.155	---	3.93	---

### GENERIC MARKING DIAGRAM\*

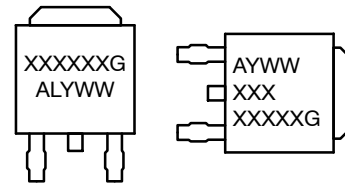

IC

Discrete

- XXXXXX = Device Code
- A = Assembly Location
- L = Wafer Lot
- Y = Year
- WW = Work Week
- G = Pb-Free Package

\*This information is generic. Please refer to device data sheet for actual part marking.

- |  |  |   |   |  |
|--|--|---|---|--|
| <p>STYLE 1:<br/>PIN 1. BASE<br/>2. COLLECTOR<br/>3. EMITTER<br/>4. COLLECTOR</p> | <p>STYLE 2:<br/>PIN 1. GATE<br/>2. DRAIN<br/>3. SOURCE<br/>4. DRAIN</p>          | <p>STYLE 3:<br/>PIN 1. ANODE<br/>2. CATHODE<br/>3. ANODE<br/>4. CATHODE</p> | <p>STYLE 4:<br/>PIN 1. CATHODE<br/>2. ANODE<br/>3. GATE<br/>4. ANODE</p>              | <p>STYLE 5:<br/>PIN 1. GATE<br/>2. ANODE<br/>3. CATHODE<br/>4. ANODE</p>     |
| <p>STYLE 6:<br/>PIN 1. MT1<br/>2. MT2<br/>3. GATE<br/>4. MT2</p>                 | <p>STYLE 7:<br/>PIN 1. GATE<br/>2. COLLECTOR<br/>3. EMITTER<br/>4. COLLECTOR</p> | <p>STYLE 8:<br/>PIN 1. N/C<br/>2. CATHODE<br/>3. ANODE<br/>4. CATHODE</p>   | <p>STYLE 9:<br/>PIN 1. ANODE<br/>2. CATHODE<br/>3. RESISTOR ADJUST<br/>4. CATHODE</p> | <p>STYLE 10:<br/>PIN 1. CATHODE<br/>2. ANODE<br/>3. CATHODE<br/>4. ANODE</p> |

### SOLDERING FOOTPRINT\*

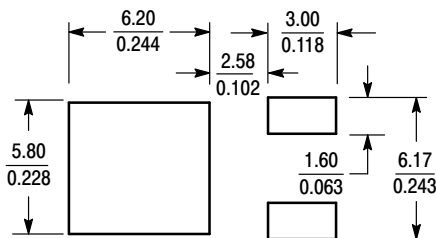

SCALE 3:1 (mm / inches)

\*For additional information on our Pb-Free strategy and soldering details, please download the ON Semiconductor Soldering and Mounting Techniques Reference Manual, SOLDERRM/D.

DOCUMENT NUMBER:	98AON10527D	Electronic versions are uncontrolled except when accessed directly from the Document Repository. Printed versions are uncontrolled except when stamped "CONTROLLED COPY" in red.
DESCRIPTION:	DPAK (SINGLE GAUGE)	PAGE 1 OF 1

ON Semiconductor and ON are trademarks of Semiconductor Components Industries, LLC dba ON Semiconductor or its subsidiaries in the United States and/or other countries. ON Semiconductor reserves the right to make changes without further notice to any products herein. ON Semiconductor makes no warranty, representation or guarantee regarding the suitability of its products for any particular purpose, nor does ON Semiconductor assume any liability arising out of the application or use of any product or circuit, and specifically disclaims any and all liability, including without limitation special, consequential or incidental damages. ON Semiconductor does not convey any license under its patent rights nor the rights of others.

ON Semiconductor and  are trademarks of Semiconductor Components Industries, LLC dba ON Semiconductor or its subsidiaries in the United States and/or other countries. ON Semiconductor owns the rights to a number of patents, trademarks, copyrights, trade secrets, and other intellectual property. A listing of ON Semiconductor's product/patent coverage may be accessed at [www.onsemi.com/site/pdf/Patent-Marking.pdf](http://www.onsemi.com/site/pdf/Patent-Marking.pdf). ON Semiconductor reserves the right to make changes without further notice to any products herein. ON Semiconductor makes no warranty, representation or guarantee regarding the suitability of its products for any particular purpose, nor does ON Semiconductor assume any liability arising out of the application or use of any product or circuit, and specifically disclaims any and all liability, including without limitation special, consequential or incidental damages. Buyer is responsible for its products and applications using ON Semiconductor products, including compliance with all laws, regulations and safety requirements or standards, regardless of any support or applications information provided by ON Semiconductor. "Typical" parameters which may be provided in ON Semiconductor data sheets and/or specifications can and do vary in different applications and actual performance may vary over time. All operating parameters, including "Typicals" must be validated for each customer application by customer's technical experts. ON Semiconductor does not convey any license under its patent rights nor the rights of others. ON Semiconductor products are not designed, intended, or authorized for use as a critical component in life support systems or any FDA Class 3 medical devices or medical devices with a same or similar classification in a foreign jurisdiction or any devices intended for implantation in the human body. Should Buyer purchase or use ON Semiconductor products for any such unintended or unauthorized application, Buyer shall indemnify and hold ON Semiconductor and its officers, employees, subsidiaries, affiliates, and distributors harmless against all claims, costs, damages, and expenses, and reasonable attorney fees arising out of, directly or indirectly, any claim of personal injury or death associated with such unintended or unauthorized use, even if such claim alleges that ON Semiconductor was negligent regarding the design or manufacture of the part. ON Semiconductor is an Equal Opportunity/Affirmative Action Employer. This literature is subject to all applicable copyright laws and is not for resale in any manner.

## PUBLICATION ORDERING INFORMATION

### LITERATURE FULFILLMENT:

Email Requests to: [orderlit@onsemi.com](mailto:orderlit@onsemi.com)

ON Semiconductor Website: [www.onsemi.com](http://www.onsemi.com)

### TECHNICAL SUPPORT

North American Technical Support:  
Voice Mail: 1 800-282-9855 Toll Free USA/Canada  
Phone: 011 421 33 790 2910

Europe, Middle East and Africa Technical Support:

Phone: 00421 33 790 2910

For additional information, please contact your local Sales Representative