

MOSFET – Power, N-Channel, SUPERFET® III 800 V, 360 mΩ, 13 A

NTPF360N80S3Z

Description

800 V SUPERFET III MOSFET is ON Semiconductor's high performance MOSFET family offering 800 V breakdown voltage.

New 800 V SUPERFET III MOSFET which is optimized for primary switch of flyback converter, enables lower switching losses and case temperature without sacrificing EMI performance thanks to its optimized design. In addition, internal Zener Diode significantly improves ESD capability.

This new family of 800 V SUPERFET III MOSFET enables to make more efficient, compact, cooler and more robust applications because of its remarkable performance in switching power applications such as Laptop adapter, Audio, Lighting, ATX power and industrial power supplies.

Features

- Typ. $R_{DS(on)}$ = 300 mΩ
- Ultra Low Gate Charge (Typ. Q_g = 25.3 nC)
- Low Stored Energy in Output Capacitance (E_{oss} = 2.72 μJ @ 400 V)
- 100% Avalanche Tested
- ESD Improved Capability with Zener Diode
- RoHS Compliant

Applications

- Adapters / Chargers
- LED Lighting
- AUX Power
- Audio
- Industrial Power



ON Semiconductor®

www.onsemi.com

$V_{(BR)DSS}$	$R_{DS(ON)}$ MAX	I_D MAX
800 V	360 mΩ	13 A

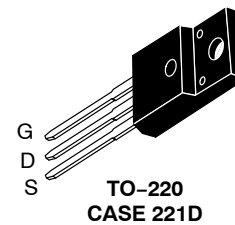
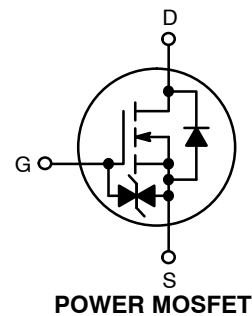

MARKING DIAGRAM

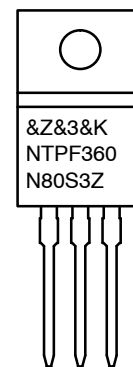

&Z = Assembly Plant Code
 &3 = Data Code (Year & Week)
 &K = Lot
 NTPF360N80S3Z = Specific Device Code

ORDERING INFORMATION

See detailed ordering and shipping information on page 2 of this data sheet.

NTPF360N80S3Z

ABSOLUTE MAXIMUM RATINGS (T_J = 25°C, unless otherwise noted)

Symbol	Parameter	Value	Unit
V _{DSS}	Drain-to-Source Voltage	800	V
V _{GS}	Gate-to-Source Voltage	DC	±20
		AC (f > 1 Hz)	±30
I _D	Drain Current	Continuous (T _C = 25°C)	13*
		Continuous (T _C = 100°C)	8.2*
I _{DM}	Drain Current	Pulsed (Note 1)	32.5*
E _{AS}	Single Pulsed Avalanche Energy (Note 2)	40	mJ
I _{AS}	Avalanche Current (Note 2)	2.0	A
E _{AR}	Repetitive Avalanche Energy (Note 1)	0.31	mJ
dv/dt	MOSFET dv/dt	100	V/ns
	Peak Diode Recovery dv/dt (Note 3)	10	
P _D	Power Dissipation	(T _C = 25°C)	31
		Derate Above 25°C	0.168
T _J , T _{STG}	Operating and Storage Temperature Range	-55 to +150	°C
T _L	Lead Temperature Soldering Reflow for Soldering Purposes (1/8" from Case for 10 seconds)	260	°C

Stresses exceeding those listed in the Maximum Ratings table may damage the device. If any of these limits are exceeded, device functionality should not be assumed, damage may occur and reliability may be affected.

*Drain current limited by maximum junction temperature

1. Repetitive rating: pulse-width limited by maximum junction temperature.
2. I_{AS} = 2.0 A, R_G = 25 Ω, starting T_J = 25°C.
3. I_{SD} ≤ 3.25 A, di/dt ≤ 200 A/μs, V_{DD} ≤ 400 V, starting T_J = 25°C.

THERMAL RESISTANCE RATINGS

Symbol	Parameter	Value	Unit
R _{θJC}	Junction-to-Case - Steady State	4.04	°C/W
R _{θJA}	Junction-to-Ambient - Steady State	62.5	

PACKAGE MARKING AND ORDERING INFORMATION

Part Number	Top Marking	Package	Packing Method	Reel Size	Tape Width	Quantity
NTPF360N80S3Z	NTPF360N80S3Z	TO-220F	Tube	N/A	N/A	50 Units

NTPF360N80S3Z

ELECTRICAL CHARACTERISTICS ($T_J = 25^\circ\text{C}$ unless otherwise noted)

Symbol	Parameter	Test Conditions	Min	Typ	Max	Unit
--------	-----------	-----------------	-----	-----	-----	------

OFF CHARACTERISTICS

BV _{DSS}	Drain-to-Source Breakdown Voltage	V _{GS} = 0 V, I _D = 1 mA, T _J = 25°C	800			V
		V _{GS} = 0 V, I _D = 1 mA, T _J = 150°C	900			V
ΔBV _{DSS} / ΔT _J	Breakdown Voltage Temperature Coefficient	I _D = 1 mA, Referenced to 25°C		1.1		V/°C
I _{DSS}	Zero Gate Voltage Drain Current	V _{DS} = 800 V, V _{GS} = 0 V			1	μA
		V _{DS} = 640 V, T _C = 125°C		0.8		
I _{GSS}	Gate-to-Body Leakage Current	V _{GS} = ±20 V, V _{DS} = 0 V			1	μA

ON CHARACTERISTICS

V _{GS(th)}	Gate Threshold Voltage	V _{GS} = V _{DS} , I _D = 0.3 mA	2.2		3.8	V
R _{DS(on)}	Static Drain-to-Source On Resistance	V _{GS} = 10 V, I _D = 6.5 A		300	360	mΩ
g _{FS}	Forward Transconductance	V _{DS} = 20 V, I _D = 6.5 A		13.8		S

DYNAMIC CHARACTERISTICS

C _{iss}	Input Capacitance	V _{DS} = 400 V, V _{GS} = 0 V, f = 250 kHz		1143		pF
C _{oss}	Output Capacitance			18.1		pF
C _{oss(eff.)}	Effective Output Capacitance	V _{DS} = 0 V to 400 V, V _{GS} = 0 V		236.4		pF
C _{oss(er.)}	Energy Related Output Capacitance	V _{DS} = 0 V to 400 V, V _{GS} = 0 V		34		pF
Q _{g(tot)}	Total Gate Charge at 10 V	V _{DS} = 400 V, I _D = 6.5 A, V _{GS} = 10 V (Note 4)		25.3		nC
Q _{gs}	Gate-to-Source Gate Charge			5.3		nC
Q _{gd}	Gate-to-Drain "Miller" Charge			8.3		nC
ESR	Equivalent Series Resistance	f = 1 MHz		4		Ω

SWITCHING CHARACTERISTICS

t _{d(on)}	Turn-On Delay Time	V _{DD} = 400 V, I _D = 6.5 A, V _{GS} = 10 V, R _g = 25 Ω (Note 4)		21.2		ns
t _r	Turn-On Rise Time			18.5		ns
t _{d(off)}	Turn-Off Delay Time			110		ns
t _f	Turn-Off Fall Time			17.7		ns

SOURCE-DRAIN DIODE CHARACTERISTICS

I _S	Maximum Continuous Source-to-Drain Diode Forward Current			13		A
I _{SM}	Maximum Pulsed Source-to-Drain Diode Forward Current			32.5		A
V _{SD}	Source-to-Drain Diode Forward Voltage	V _{GS} = 0 V, I _{SD} = 6.5 A		1.2		V
t _{rr}	Reverse Recovery Time	V _{GS} = 0 V, I _{SD} = 3.25 A, dI _F /dt = 100 A/μs		370		ns
Q _{rr}	Reverse Recovery Charge			3.0		μC

Product parametric performance is indicated in the Electrical Characteristics for the listed test conditions, unless otherwise noted. Product performance may not be indicated by the Electrical Characteristics if operated under different conditions.

4. Essentially independent of operating temperature typical characteristics.

SUPERFET is a registered trademark of Semiconductor Components Industries, LLC (SCILLC) or its subsidiaries in the United States and/or other countries.

NTPF360N80S3Z

TYPICAL CHARACTERISTICS

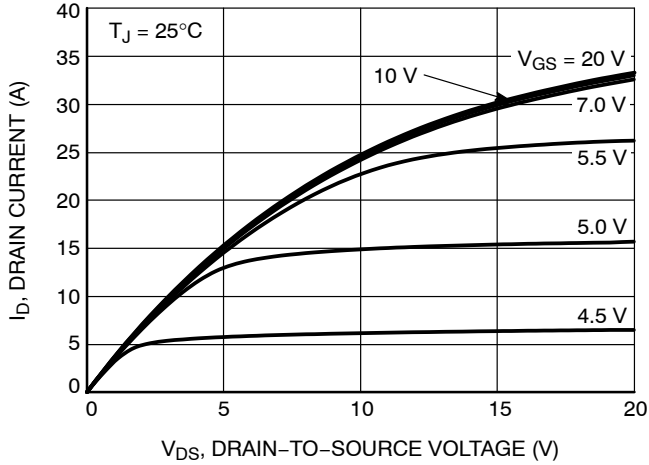

Figure 1. On-Region Characteristics

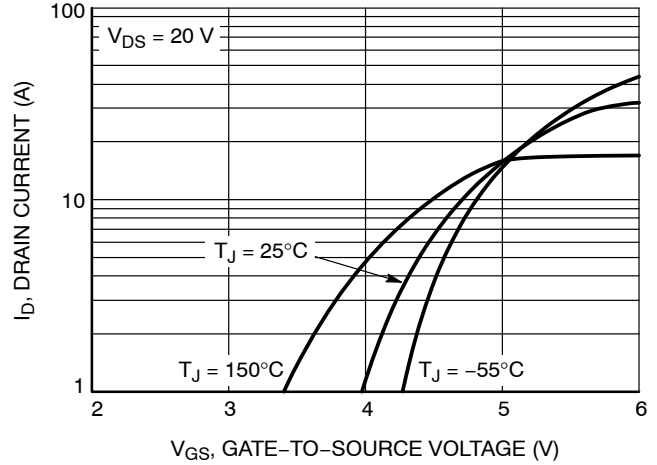

Figure 2. Transfer Characteristics

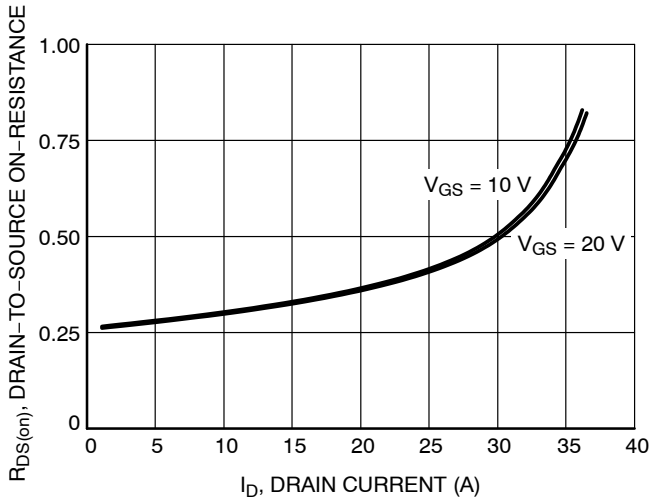

Figure 3. On Resistance vs. Drain Current

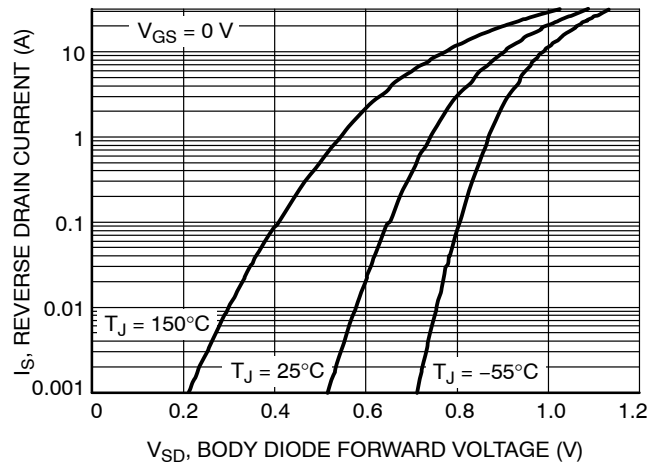

Figure 4. Diode Forward Voltage vs. Current

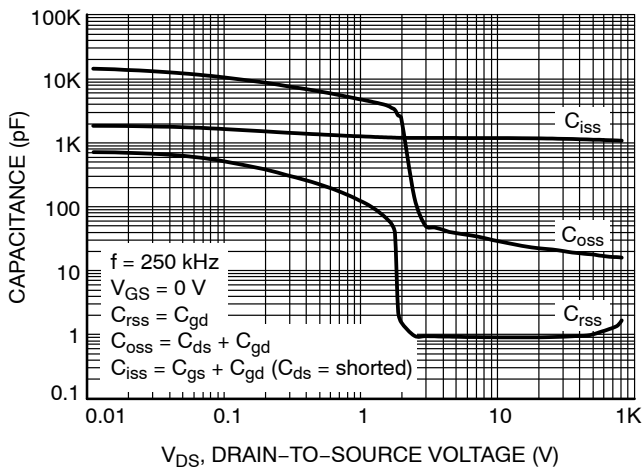

Figure 5. Capacitance Characteristics

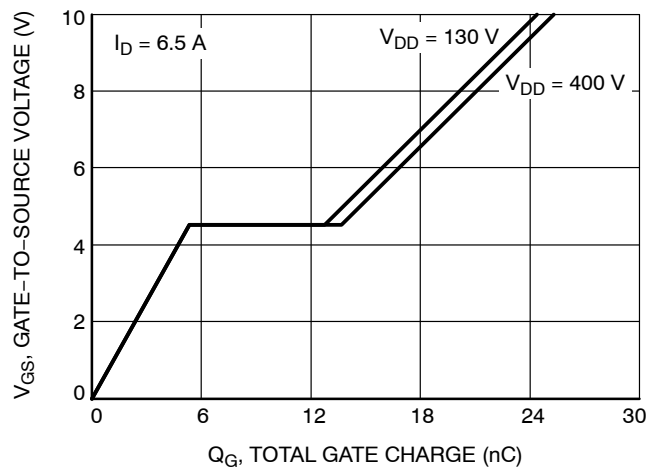

Figure 6. Gate Charge Characteristics

NTPF360N80S3Z

TYPICAL CHARACTERISTICS

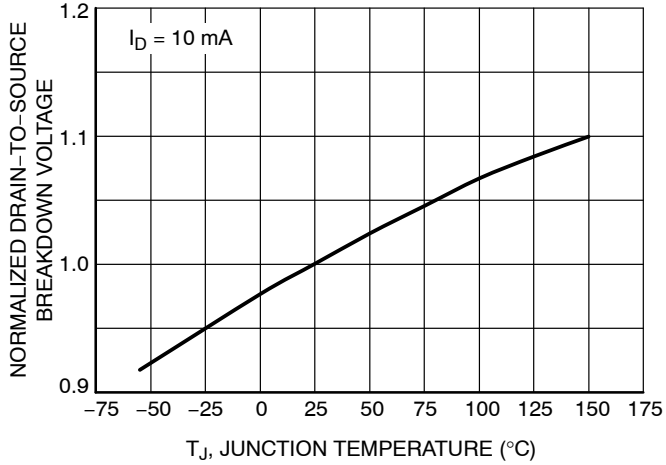

Figure 7. Normalized BV_{DSS} vs. Temperature

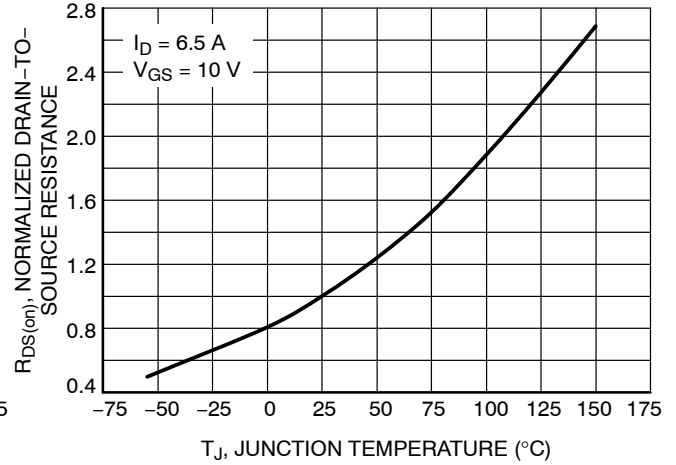

Figure 8. On-Resistance Variation vs. Temperature

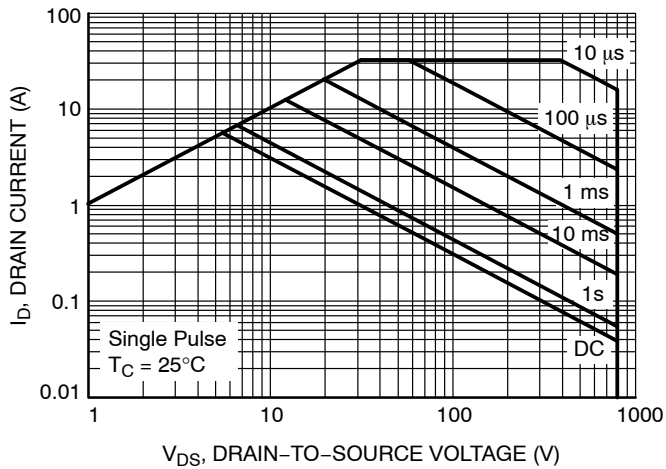

Figure 9. Safe Operating Area

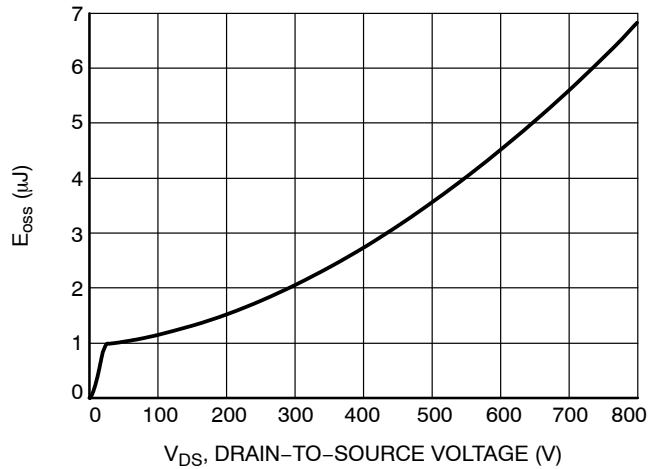

Figure 10. E_{oss} vs. Drain-to-Switch Voltage

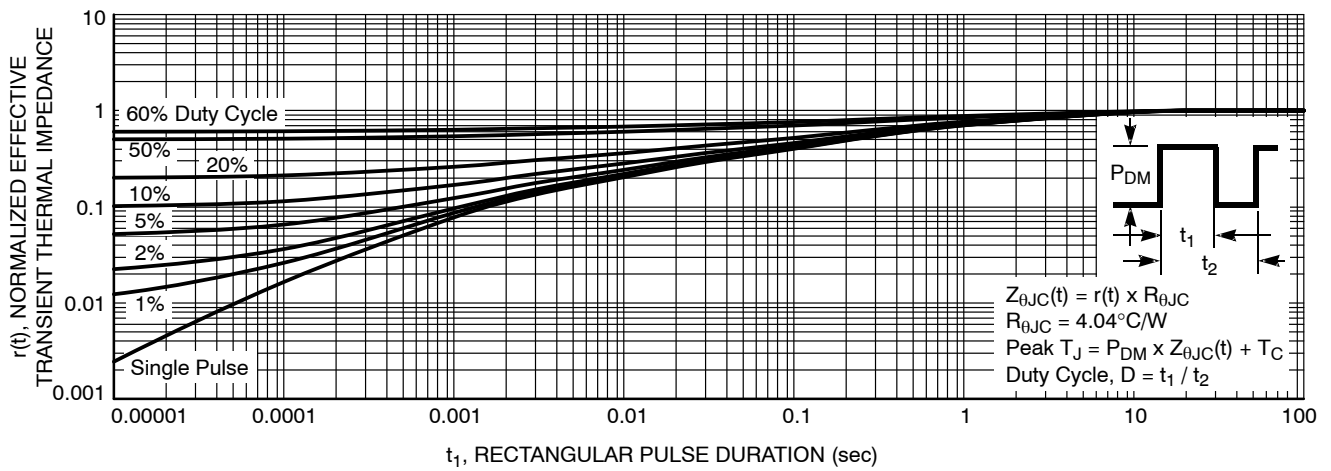

Figure 11. Transient Thermal Impedance

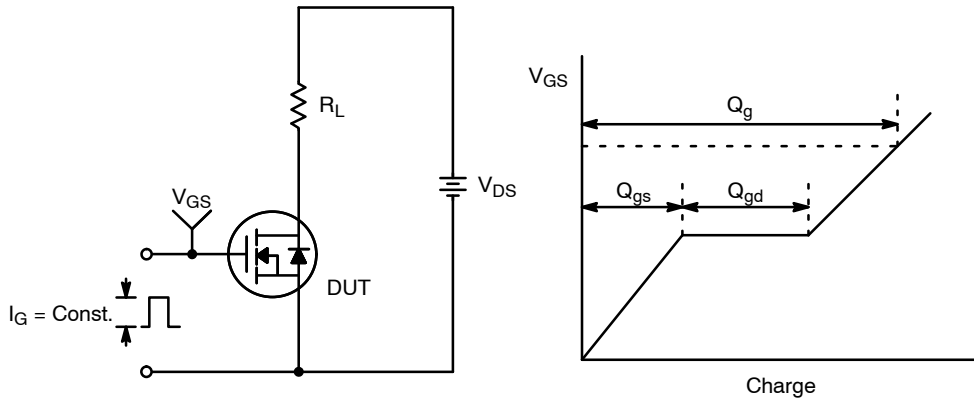

Figure 12. Gate Charge Test Circuit & Waveform

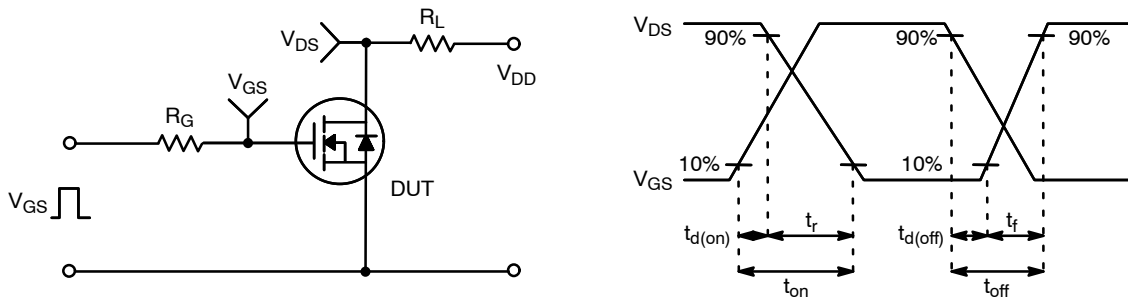

Figure 13. Resistive Switching Test Circuit & Waveforms

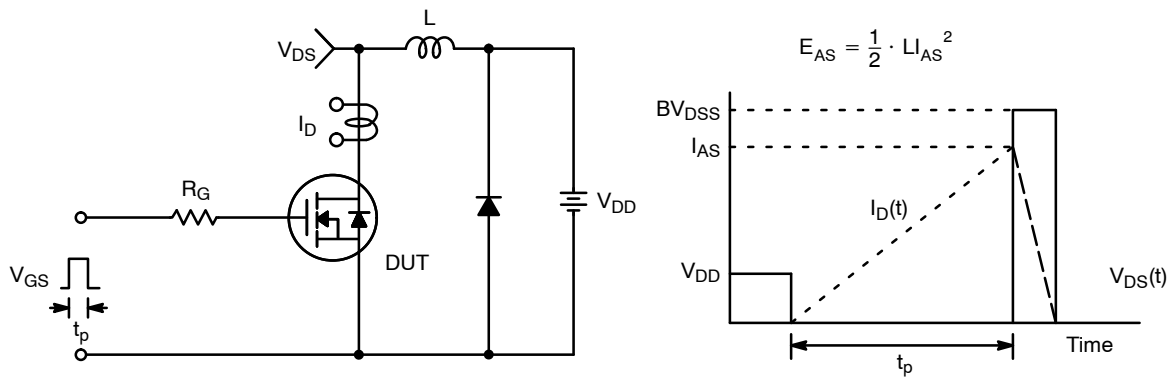

Figure 14. Unclamped Inductive Switching Test Circuit & Waveforms

NTPF360N80S3Z

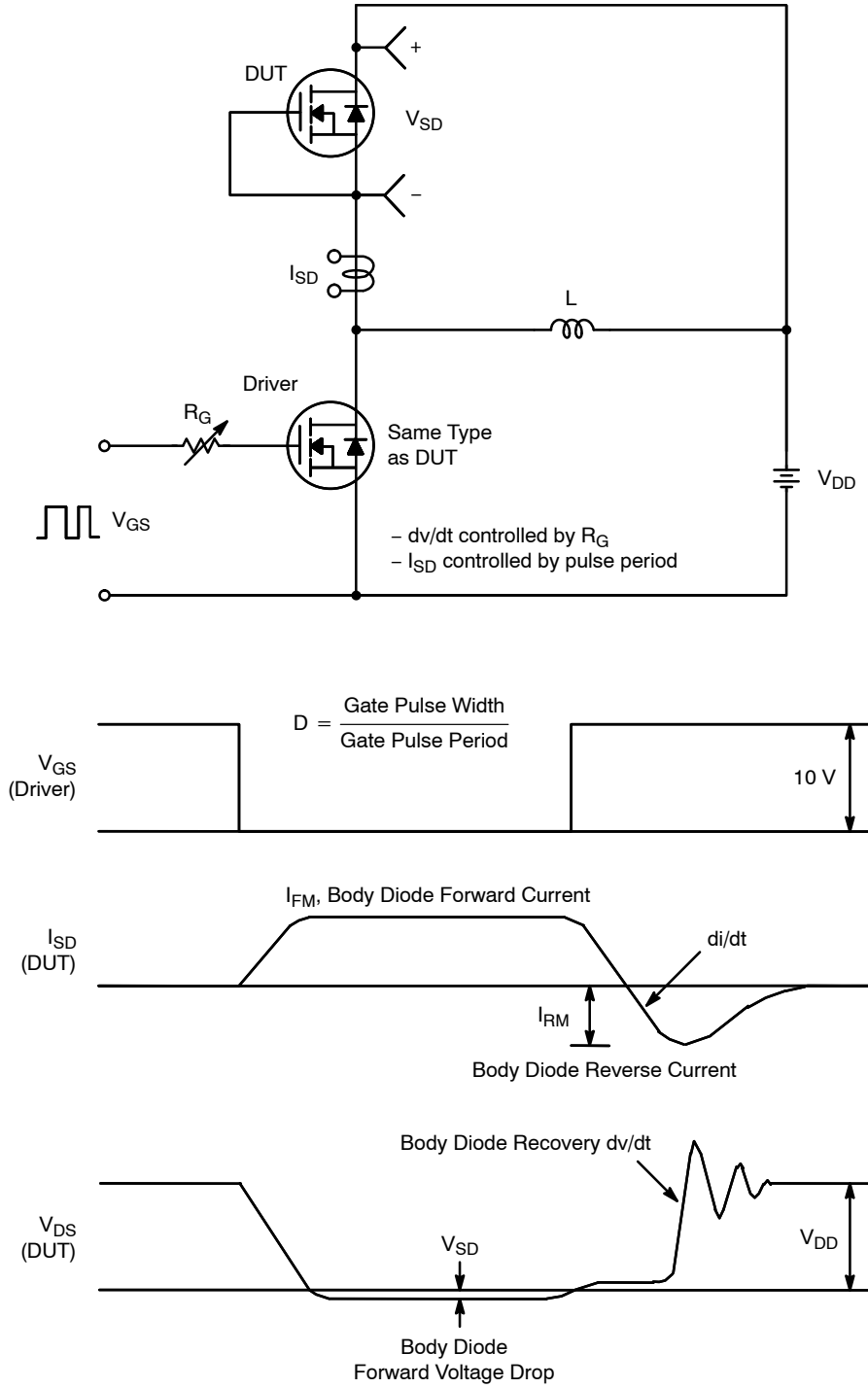
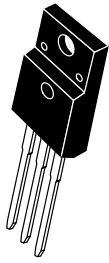

Figure 15. Peak Diode Recovery dv/dt Test Circuit & Waveforms

MECHANICAL CASE OUTLINE PACKAGE DIMENSIONS

ON Semiconductor®



SCALE 1:1

TO-220 FULLPAK CASE 221D-03 ISSUE K

DATE 27 FEB 2009

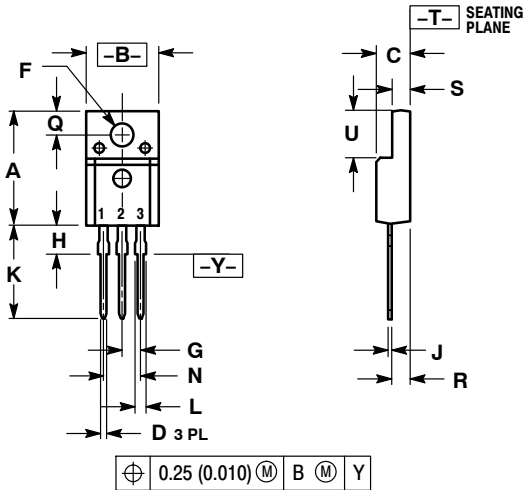

- NOTES:
- DIMENSIONING AND TOLERANCING PER ANSI Y14.5M, 1982.
 - CONTROLLING DIMENSION: INCH
 - 221D-01 THRU 221D-02 OBSOLETE, NEW STANDARD 221D-03.

DIM	INCHES		MILLIMETERS	
	MIN	MAX	MIN	MAX
A	0.617	0.635	15.67	16.12
B	0.392	0.419	9.96	10.63
C	0.177	0.193	4.50	4.90
D	0.024	0.039	0.60	1.00
F	0.116	0.129	2.95	3.28
G	0.100 BSC		2.54 BSC	
H	0.118	0.135	3.00	3.43
J	0.018	0.025	0.45	0.63
K	0.503	0.541	12.78	13.73
L	0.048	0.058	1.23	1.47
N	0.200 BSC		5.08 BSC	
Q	0.122	0.138	3.10	3.50
R	0.099	0.117	2.51	2.96
S	0.092	0.113	2.34	2.87
U	0.239	0.271	6.06	6.88

MARKING DIAGRAMS

- | | | |
|--|---|--|
| STYLE 1:
PIN 1. GATE
2. DRAIN
3. SOURCE | STYLE 2:
PIN 1. BASE
2. COLLECTOR
3. EMITTER | STYLE 3:
PIN 1. ANODE
2. CATHODE
3. ANODE |
| STYLE 4:
PIN 1. CATHODE
2. ANODE
3. CATHODE | STYLE 5:
PIN 1. CATHODE
2. ANODE
3. GATE | STYLE 6:
PIN 1. MT 1
2. MT 2
3. GATE |



Bipolar

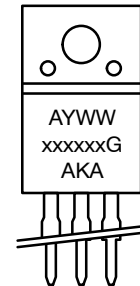

Rectifier

- | | |
|-------------------------------|---------------------------|
| xxxxxx = Specific Device Code | A = Assembly Location |
| G = Pb-Free Package | Y = Year |
| A = Assembly Location | WW = Work Week |
| Y = Year | xxxxxx = Device Code |
| WW = Work Week | G = Pb-Free Package |
| | AKA = Polarity Designator |

DOCUMENT NUMBER:	98ASB42514B	Electronic versions are uncontrolled except when accessed directly from the Document Repository. Printed versions are uncontrolled except when stamped "CONTROLLED COPY" in red.
DESCRIPTION:	TO-220 FULLPAK	PAGE 1 OF 1

ON Semiconductor and are trademarks of Semiconductor Components Industries, LLC dba ON Semiconductor or its subsidiaries in the United States and/or other countries. ON Semiconductor reserves the right to make changes without further notice to any products herein. ON Semiconductor makes no warranty, representation or guarantee regarding the suitability of its products for any particular purpose, nor does ON Semiconductor assume any liability arising out of the application or use of any product or circuit, and specifically disclaims any and all liability, including without limitation special, consequential or incidental damages. ON Semiconductor does not convey any license under its patent rights nor the rights of others.

onsemi, **Onsemi**, and other names, marks, and brands are registered and/or common law trademarks of Semiconductor Components Industries, LLC dba "**onsemi**" or its affiliates and/or subsidiaries in the United States and/or other countries. **onsemi** owns the rights to a number of patents, trademarks, copyrights, trade secrets, and other intellectual property. A listing of **onsemi**'s product/patent coverage may be accessed at www.onsemi.com/site/pdf/Patent-Marking.pdf. **onsemi** reserves the right to make changes at any time to any products or information herein, without notice. The information herein is provided "as-is" and **onsemi** makes no warranty, representation or guarantee regarding the accuracy of the information, product features, availability, functionality, or suitability of its products for any particular purpose, nor does **onsemi** assume any liability arising out of the application or use of any product or circuit, and specifically disclaims any and all liability, including without limitation special, consequential or incidental damages. Buyer is responsible for its products and applications using **onsemi** products, including compliance with all laws, regulations and safety requirements or standards, regardless of any support or applications information provided by **onsemi**. "Typical" parameters which may be provided in **onsemi** data sheets and/or specifications can and do vary in different applications and actual performance may vary over time. All operating parameters, including "Typicals" must be validated for each customer application by customer's technical experts. **onsemi** does not convey any license under any of its intellectual property rights nor the rights of others. **onsemi** products are not designed, intended, or authorized for use as a critical component in life support systems or any FDA Class 3 medical devices or medical devices with a same or similar classification in a foreign jurisdiction or any devices intended for implantation in the human body. Should Buyer purchase or use **onsemi** products for any such unintended or unauthorized application, Buyer shall indemnify and hold **onsemi** and its officers, employees, subsidiaries, affiliates, and distributors harmless against all claims, costs, damages, and expenses, and reasonable attorney fees arising out of, directly or indirectly, any claim of personal injury or death associated with such unintended or unauthorized use, even if such claim alleges that **onsemi** was negligent regarding the design or manufacture of the part. **onsemi** is an Equal Opportunity/Affirmative Action Employer. This literature is subject to all applicable copyright laws and is not for resale in any manner.

ADDITIONAL INFORMATION

TECHNICAL PUBLICATIONS:

Technical Library: www.onsemi.com/design/resources/technical-documentation
onsemi Website: www.onsemi.com

ONLINE SUPPORT: www.onsemi.com/support

For additional information, please contact your local Sales Representative at www.onsemi.com/support/sales