

Naos Raptor 20A: Non-Isolated DC-DC Power Modules

4.5Vdc –14Vdc input; 0.59Vdc to 6Vdc output; 20A Output Current

TUNABLE
LOOP™



RoHS Compliant

Applications

- Distributed power architectures
- Intermediate bus voltage applications
- Telecommunications equipment
- Servers and storage applications
- Networking equipment

Features

- Compliant to RoHS Directive 2011/65/EU and amended Directive (EU) 2015/863 (Z versions)
- Compliant to REACH Directive (EC) No 1907/2006
- Compatible in a Pb-free or SnPb wave-soldering environment (Z versions)
- Wide input voltage range (4.5Vdc-14Vdc)
- Output voltage programmable from 0.59Vdc to 6Vdc via external resistor
- Tunable Loop™ to optimize dynamic output voltage response
- Fixed switching frequency
- Output overcurrent protection (non-latching)
- Over temperature protection
- Remote On/Off
- Remote Sense
- Power Good Signal
- Small size: 36.8 mm x 15.5 mm x 9.2 mm
(1.45 in. x 0.61 in. x 0.36 in.)
- Wide operating temperature range (-40°C to 85°C)
- ANSI/UL* 62368-1 and CAN/CSA† C22.2 No. 62368-1 Recognized, DIN VDE‡ 0868-1/A11:2017 (EN62368-1:2014/A11:2017)
- ISO** 9001 and ISO 14001 certified manufacturing facilities

Description

The Naos Raptor 20A SIP power modules are non-isolated dc-dc converters in an industry standard package that can deliver up to 20A of output current with a full load efficiency of 91% at 3.3Vdc output voltage ($V_{IN} = 12Vdc$). These modules operate over a wide range of input voltage ($V_{IN} = 4.5Vdc-13.8Vdc$) and provide a precisely regulated output voltage from 0.59Vdc to 6Vdc, programmable via an external resistor. Features include remote On/Off, adjustable output voltage, over current and over temperature protection. A new feature, the Tunable Loop™, allows the user to optimize the dynamic response of the converter to match the load.

* UL is a registered trademark of Underwriters Laboratories, Inc.

† CSA is a registered trademark of Canadian Standards Association.

‡ VDE is a trademark of Verband Deutscher Elektrotechniker e.V.

** ISO is a registered trademark of the International Organization of Standards

Naos Raptor 20A: Non-Isolated DC-DC Power Modules

4.5Vdc –14Vdc input; 0.59Vdc to 6Vdc output; 20A Output Current

Absolute Maximum Ratings

Stresses in excess of the absolute maximum ratings can cause permanent damage to the device. These are absolute stress ratings only, functional operation of the device is not implied at these or any other conditions in excess of those given in the operations sections of the data sheet. Exposure to absolute maximum ratings for extended periods can adversely affect the device reliability.

Parameter	Device	Symbol	Min	Max	Unit
Input Voltage Continuous	All	V_{IN}	-0.3	15	Vdc
Operating Ambient Temperature (see Thermal Considerations section)	All	T_A	-40	85	°C
Storage Temperature	All	T_{stg}	-55	125	°C

Electrical Specifications

Unless otherwise indicated, specifications apply over all operating input voltage, resistive load, and temperature conditions.

Parameter	Device	Symbol	Min	Typ	Max	Unit
Operating Input Voltage	All	V_{IN}	4.5	12.0	13.8	Vdc
Maximum Input Current ($V_{IN} = V_{IN, min}$ to $V_{IN, max}$, $I_O = I_{O, max}$, $V_{O, set} = 3.3Vdc$)	All	$I_{IN, max}$			20	Adc
Input No Load Current ($V_{IN} = 12Vdc$, $I_O = 0$, module ON)	$V_{O, set} = 0.6 Vdc$ $V_{O, set} = 5.0Vdc$	$I_{IN, No load}$ $I_{IN, No load}$		50 110		mA mA
Input Stand-by Current ($V_{IN} = 12Vdc$, module disabled)	All	$I_{IN, stand-by}$		6.08		mA
Inrush Transient	All	I^2t			1	A ² s
Input Reflected Ripple Current, peak-to-peak (5Hz to 20MHz, 1 μ H source impedance; $V_{IN, min}$ to $V_{IN, max}$, $I_O = I_{O, max}$; See Test configuration section)	All			34.4		mAp-p
Input Ripple Rejection (120Hz)	All			43		dB

Naos Raptor 20A: Non-Isolated DC-DC Power Modules

4.5Vdc –14Vdc input; 0.59Vdc to 6Vdc output; 20A Output Current

Electrical Specifications (continued)

Parameter	Device	Symbol	Min	Typ	Max	Unit
Output Voltage Set-point (with 0.5% tolerance for external resistor used to set output voltage)	All	$V_{O, set}$	-1.5		+1.5	% $V_{O, set}$
Output Voltage (Over all operating input voltage, resistive load, and temperature conditions until end of life)	All	$V_{O, set}$	-3.0	—	+3.0	% $V_{O, set}$
Adjustment Range Selected by an external resistor	All	V_O	0.59		6	Vdc
Output Regulation (for $V_O \geq 2.5V$)						
Line ($V_{IN}=V_{IN, min}$ to $V_{IN, max}$)	All		-0.2	—	+0.2	% $V_{O, set}$
Load ($I_O=I_{O, min}$ to $I_{O, max}$)	All			—	0.8	% $V_{O, set}$
Output Regulation (for $V_O < 2.5V$)						
Line ($V_{IN}=V_{IN, min}$ to $V_{IN, max}$)	All		-5	—	+5	mV
Load ($I_O=I_{O, min}$ to $I_{O, max}$)	All			—	20	mV
Output Ripple and Noise on nominal output ($V_{IN}=V_{IN, nom}$ and $I_O=I_{O, min}$ to $I_{O, max}$, $C_{out} = 0\mu F$)						
Peak-to-Peak (5Hz to 20MHz bandwidth) $V_O = 0.59V$	$V_O = 0.59V$		—		20	mV _{pk-pk}
Peak-to-Peak (5Hz to 20MHz bandwidth) $V_O = 1.2V$	$V_O = 1.2V$		—		23	mV _{pk-pk}
Peak-to-Peak (5Hz to 20MHz bandwidth) $V_O = 1.8V$	$V_O = 1.8V$		—		25	mV _{pk-pk}
Peak-to-Peak (5Hz to 20MHz bandwidth) $V_O = 2.5V$	$V_O = 2.5V$		—		30	mV _{pk-pk}
Peak-to-Peak (5Hz to 20MHz bandwidth) $V_O = 3.3V$	$V_O = 3.3V$		—		40	mV _{pk-pk}
Peak-to-Peak (5Hz to 20MHz bandwidth) $V_O = 5.0V$	$V_O = 5.0V$		—		50	mV _{pk-pk}
Peak-to-Peak (5Hz to 20MHz bandwidth) $V_O = 6.0V$	$V_O = 6.0V$		—		60	mV _{pk-pk}
External Capacitance ¹ Without the Tunable Loop™ ESR $\geq 1 m\Omega$	All	$C_{O, max}$	—	—	300	μF
With the Tunable Loop™ ESR $\geq 0.15 m\Omega$	All	$C_{O, max}$	0	—	1500	μF
ESR $\geq 10 m\Omega$	All	$C_{O, max}$	0	—	10000	μF
Output Current	All	I_O	0	—	20	A _{dc}
Output Current Limit Inception (Hiccup Mode)	All	$I_{O, lim}$		140		% I_O
Output Short-Circuit Current ($V_O \leq 250mV$) (Hiccup Mode)	All	$I_{O, s/c}$		1.1		Arms
Efficiency ($V_{in}=9Vdc$) $V_{IN}= 12Vdc$, $T_A=25^\circ C$ $I_O=I_{O, max}$, $V_O= V_{O, set}$	$V_{O, set} = 0.59Vdc$	η		72.7		%
	$V_{O, set} = 1.2Vdc$	η		82.3		%
	$V_{O, set} = 1.8Vdc$	η		87.5		%
	$V_{O, set} = 2.5Vdc$	η		90.2		%
	$V_{O, set} = 3.3Vdc$	η		92.1		%
	$V_{O, set} = 5.0Vdc$	η		94.3		%
	$V_{O, set} = 6.0Vdc$	η		95.0		%
Switching Frequency	All	f_{sw}	—	600	—	kHz

¹ External capacitors may require using the new Tunable Loop™ feature to ensure that the module is stable as well as getting the best transient response. See the Tunable Loop™ section for details.

Naos Raptor 20A: Non-Isolated DC-DC Power Modules

4.5Vdc –14Vdc input; 0.59Vdc to 6Vdc output; 20A Output Current

General Specifications

Parameter	Min	Typ	Max	Unit
Calculated MTBF ($V_{IN}=12V$, $V_O=5Vdc$, $I_O=0.8I_{O,max}$, $T_A=40^\circ C$) Per Telcordia Issue 2, Method I Case 3		16,061,773		Hours
Weight	—	6.6 (0.23)	—	g (oz.)

Feature Specifications

Unless otherwise indicated, specifications apply over all operating input voltage, resistive load, and temperature conditions. See Feature Descriptions for additional information.

Parameter	Device	Symbol	Min	Typ	Max	Unit
On/Off Signal Interface ($V_{IN}=V_{IN,min}$ to $V_{IN,max}$; open collector or equivalent, Signal referenced to GND) Logic High (On/Off pin open – Module ON)						
Input High Current	All	I_{IH}	0	—	0.5	mA
Input High Voltage	All	V_{IH}	1.0	—	5.5	V
Logic Low (Module OFF)						
Input Low Current	All	I_{IL}	—	—	200	μA
Input Low Voltage	All	V_{IL}	-0.3	—	0.4	V
PwGood (Power Good) Signal Interface Open Collector/Drain PwGood = High = Power Good PwGood = Low = Power Not Good Logic level low voltage, $I_{sink} = 5$ mA Sink Current, PwGood = low			0		0.35 10	V mA
Turn-On Delay and Rise Times ($V_{IN}=V_{IN,nom}$, $I_O=I_{O,max}$, V_O to within $\pm 1\%$ of steady state)						
Case 1: On/Off input is enabled and then input power is applied (delay from instant at which $V_{IN} = V_{IN,min}$ until $V_O = 10\%$ of $V_{O,set}$)	All	Tdelay		2	3	msec
Case 2: Input power is applied for at least one second and then the On/Off input is enabled (delay from instant at which On/Off is enabled until $V_O = 10\%$ of $V_{O,set}$)	All	Tdelay		2	3	msec
Output voltage Rise time (time for V_O to rise from 10% of $V_{O,set}$ to 90% of $V_{O,set}$)	All	Trise		3	6	msec
Output voltage overshoot $I_O = I_{O,max}$; $V_{IN,min} - V_{IN,max}$, $T_A = 25^\circ C$					0.5	% $V_{O,set}$
Remote Sense Range	All		—	—	0.5	V
Over Temperature Protection (See Thermal Considerations section)	All	T_{ref}		130		$^\circ C$
Input Undervoltage Lockout						
Turn-on Threshold	All			4.2		Vdc
Turn-off Threshold	All			4.1		Vdc

Naos Raptor 20A: Non-Isolated DC-DC Power Modules

4.5Vdc –14Vdc input; 0.59Vdc to 6Vdc output; 20A Output Current

Characteristic Curves

The following figures provide typical characteristics for the Naos Raptor 20A modules at 0.6Vout and 25°C.

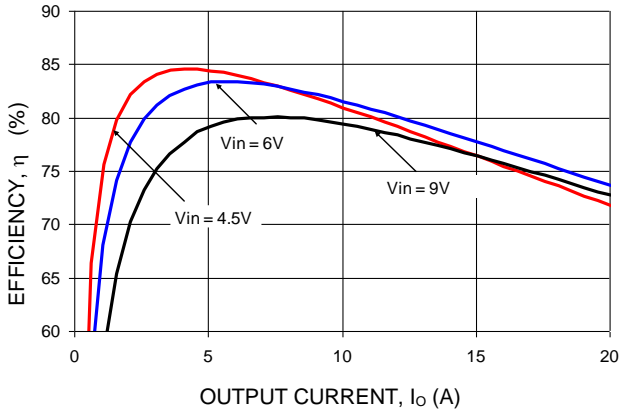

Figure 1. Converter Efficiency versus Output Current.

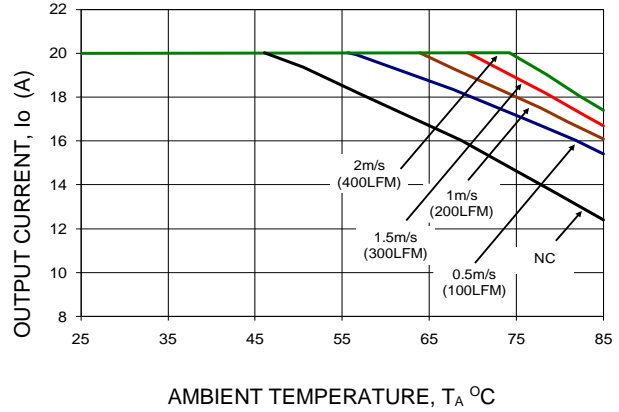

Figure 2. Derating Output Current versus Ambient Temperature and Airflow.

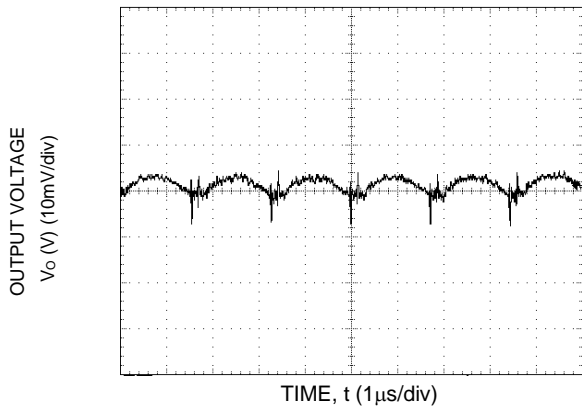

Figure 3. Typical output ripple and noise ($V_{IN} = 9V$, $I_o = I_{o,max}$).

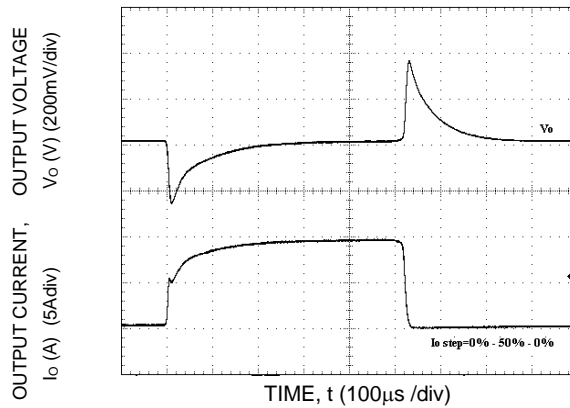

Figure 4. Transient Response to Dynamic Load Change from 0% to 50% to 0% with $V_{IN}=9V$.

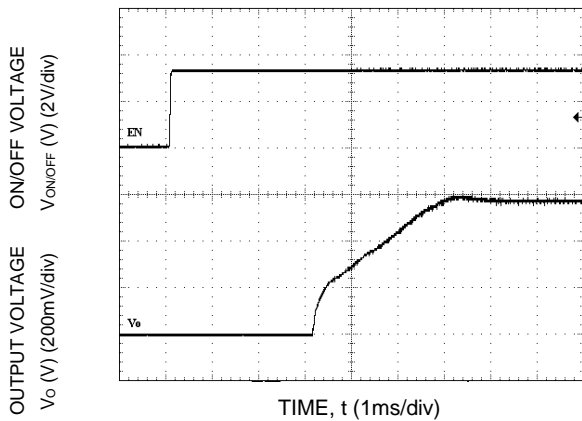

Figure 5. Typical Start-up Using On/Off Voltage ($I_o = I_{o,max}$).

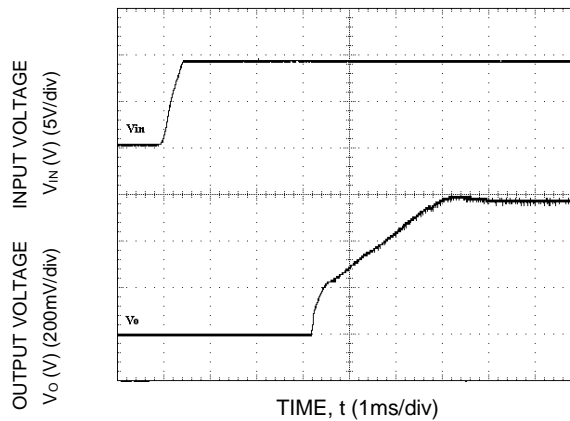

Figure 6. Typical Start-up Using Input Voltage ($V_{IN} = 9V$, $I_o = I_{o,max}$).

Naos Raptor 20A: Non-Isolated DC-DC Power Modules

4.5Vdc –14Vdc input; 0.59Vdc to 6Vdc output; 20A Output Current

Characteristic Curves (continued)

The following figures provide typical characteristics for the Naos Raptor 20A modules at 1.2V_{out} and 25°C.

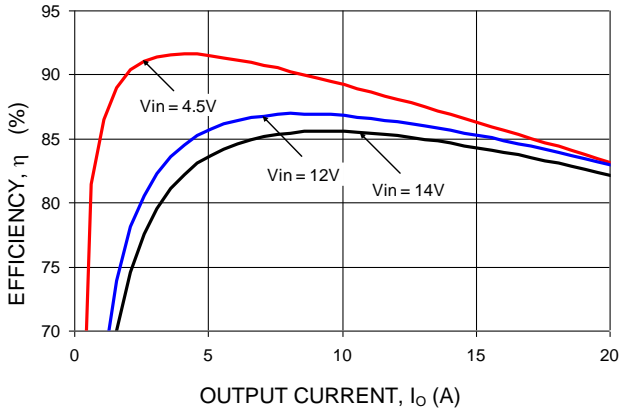

Figure 7. Converter Efficiency versus Output Current.

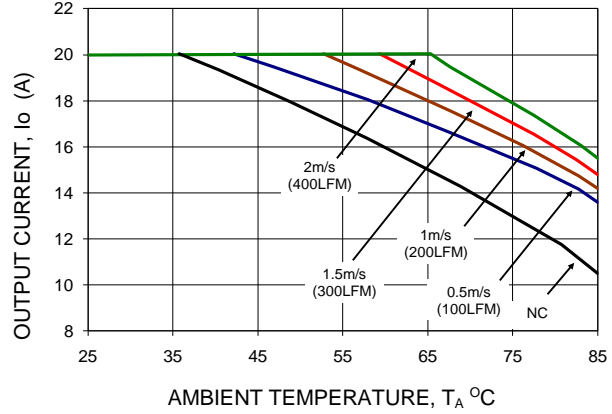

Figure 8. Derating Output Current versus Ambient Temperature and Airflow.

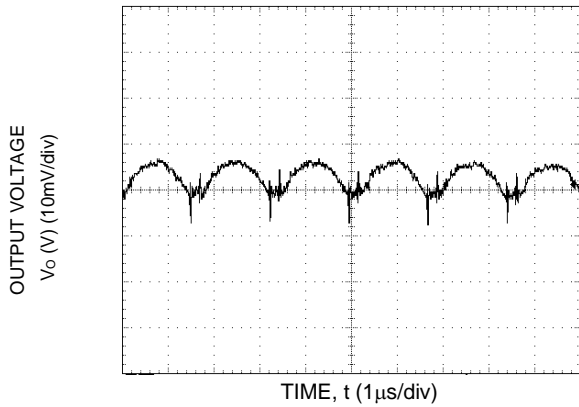

Figure 9. Typical output ripple and noise ($V_{IN} = 12V$, $I_o = I_{o,max}$).

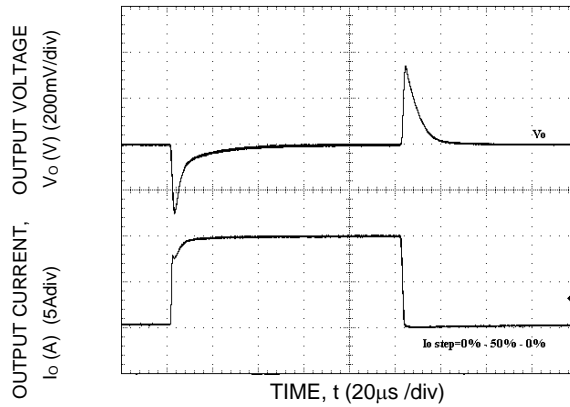

Figure 10. Transient Response to Dynamic Load Change from 0% to 50% to 0% with $V_{IN}=12V$.

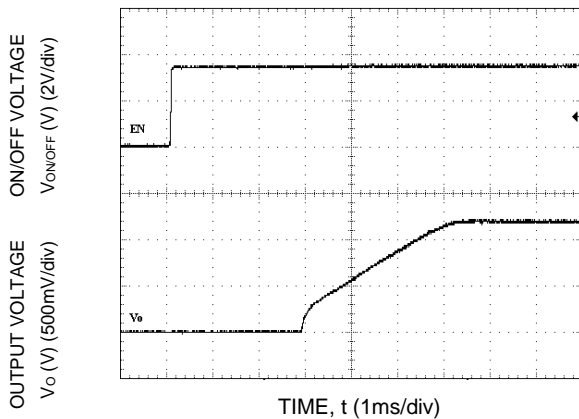

Figure 11. Typical Start-up Using On/Off Voltage ($I_o = I_{o,max}$).

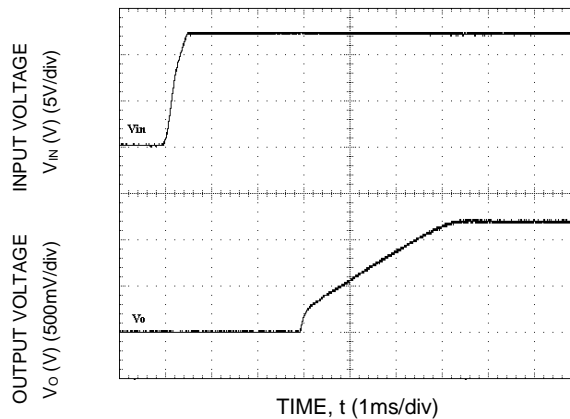

Figure 12. Typical Start-up Using Input Voltage ($V_{IN} = 12V$, $I_o = I_{o,max}$).

Naos Raptor 20A: Non-Isolated DC-DC Power Modules

4.5Vdc –14Vdc input; 0.59Vdc to 6Vdc output; 20A Output Current

Characteristic Curves (continued)

The following figures provide typical characteristics for the Naos Raptor 20A modules at 1.8V_{out} and at 25°C.

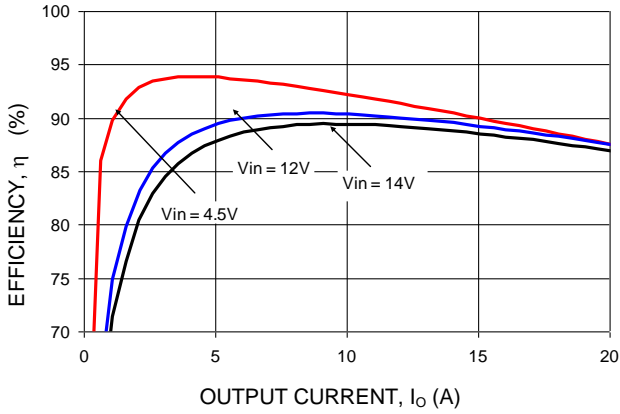

Figure 13. Converter Efficiency versus Output Current.

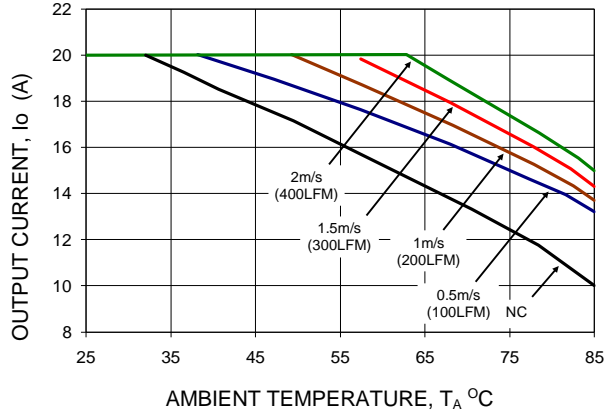

Figure 14. Derating Output Current versus Ambient Temperature and Airflow.

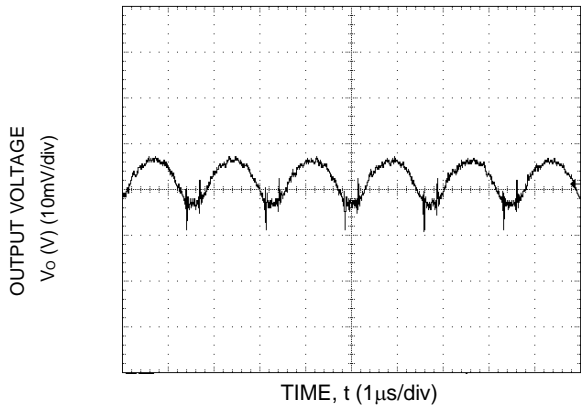

Figure 15. Typical output ripple and noise ($V_{IN} = 12V$, $I_o = I_{o,max}$).

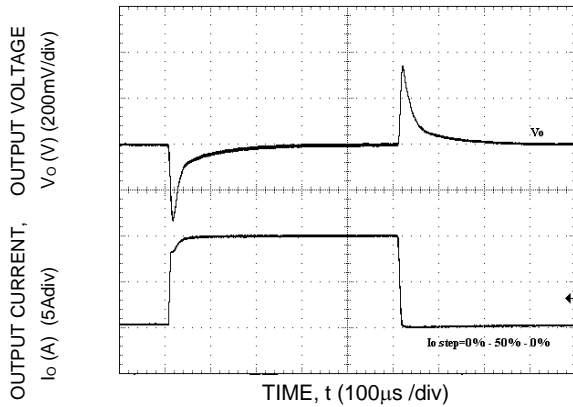

Figure 16. Transient Response to Dynamic Load Change from 0% to 50% to 0% with $V_{IN}=12V$.

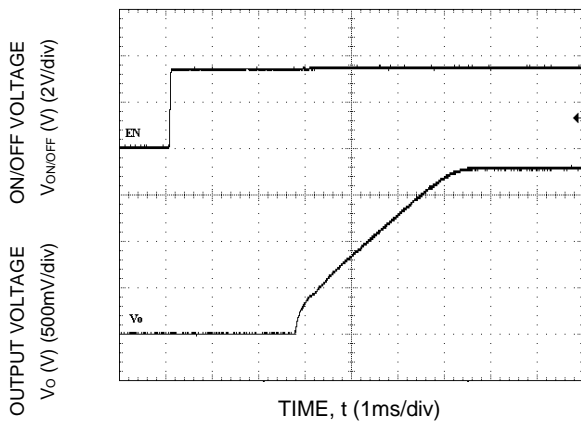

Figure 17. Typical Start-up Using On/Off Voltage ($I_o = I_{o,max}$).

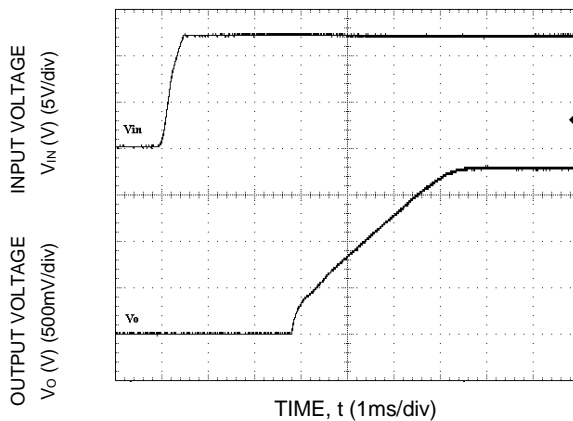

Figure 18. Typical Start-up Using Input Voltage ($V_{IN} = 12V$, $I_o = I_{o,max}$).

Naos Raptor 20A: Non-Isolated DC-DC Power Modules

4.5Vdc –14Vdc input; 0.59Vdc to 6Vdc output; 20A Output Current

Characteristic Curves (continued)

The following figures provide thermal derating curves for Naos Raptor 20A modules at 2.5Vout and 25°C.

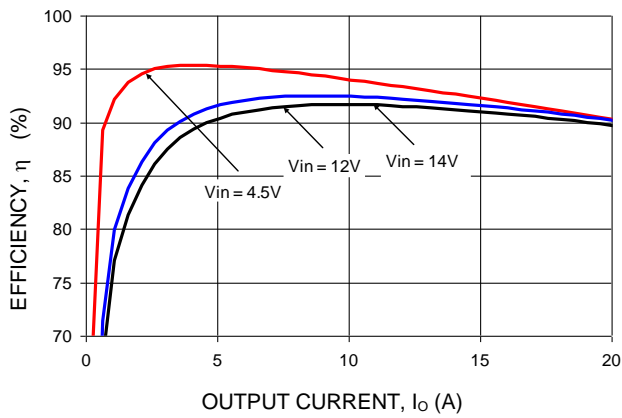

Figure 19. Converter Efficiency versus Output Current.

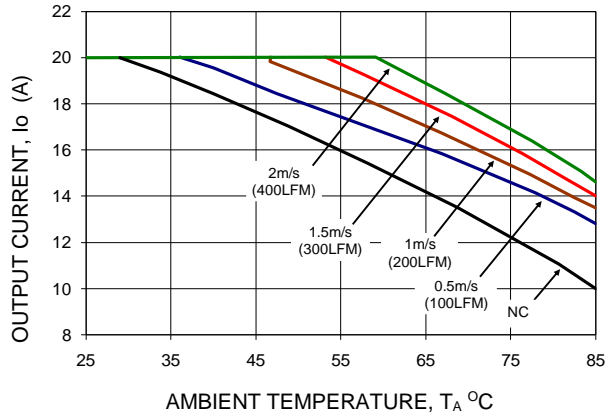

Figure 20. Derating Output Current versus Ambient Temperature and Airflow.

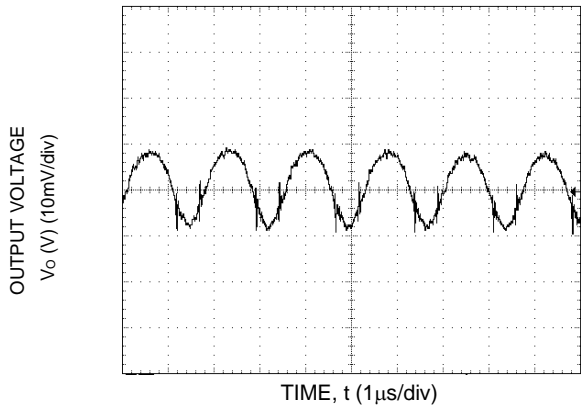

Figure 21. Typical output ripple and noise ($V_{IN} = 12V$, $I_o = I_{o,max}$).

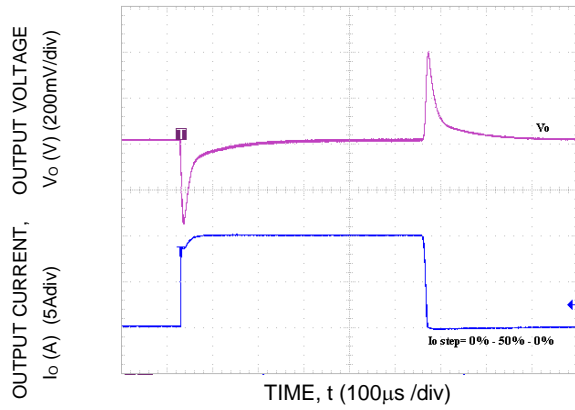

Figure 22. Transient Response to Dynamic Load Change from 0% to 50% to 0% with $V_{IN}=12V$.

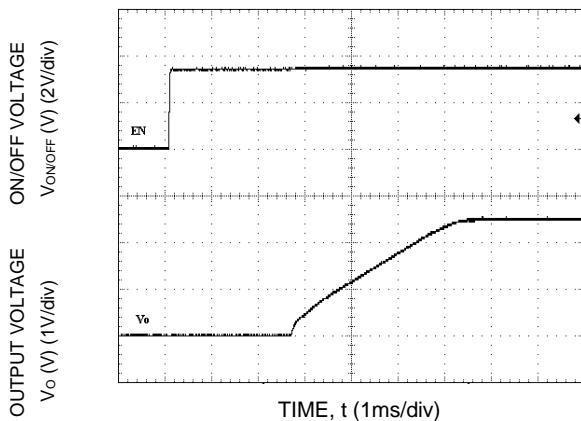

Figure 23. Typical Start-up Using On/Off Voltage ($I_o = I_{o,max}$).

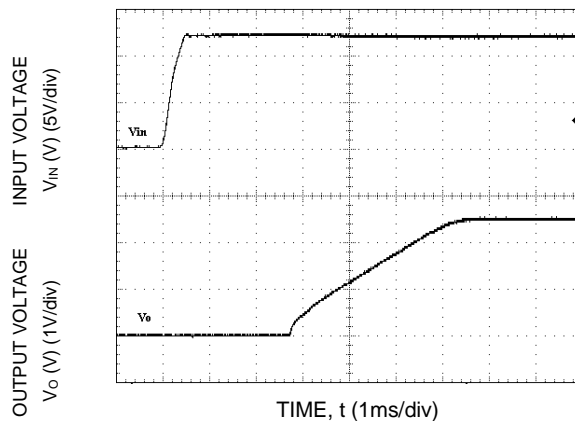

Figure 24. Typical Start-up Using Input Voltage ($V_{IN} = 12V$, $I_o = I_{o,max}$).

Naos Raptor 20A: Non-Isolated DC-DC Power Modules

4.5Vdc –14Vdc input; 0.59Vdc to 6Vdc output; 20A Output Current

Characteristic Curves (continued)

The following figures provide thermal derating curves for Naos Raptor 20A modules at 3.3V_{out} and 25°C.

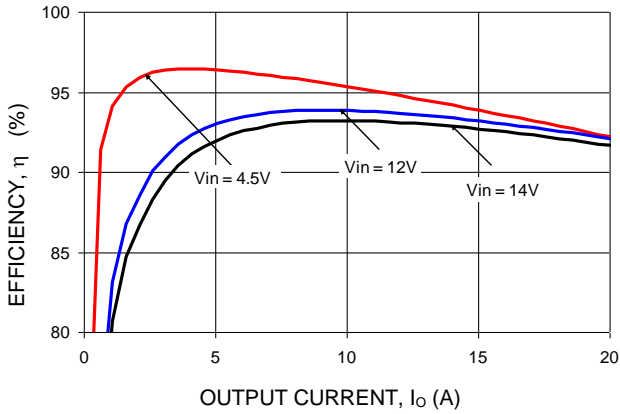

Figure 25. Converter Efficiency versus Output Current.

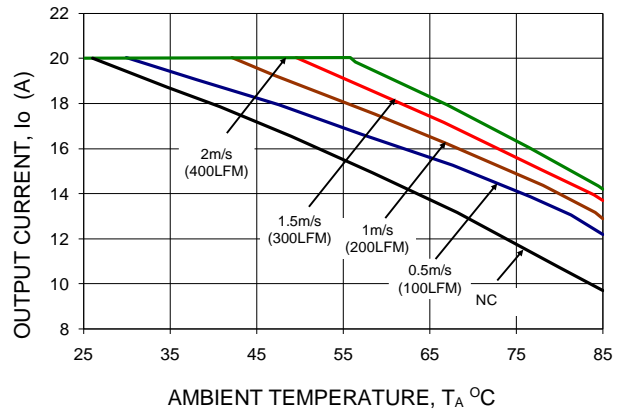

Figure 26. Derating Output Current versus Ambient Temperature and Airflow.

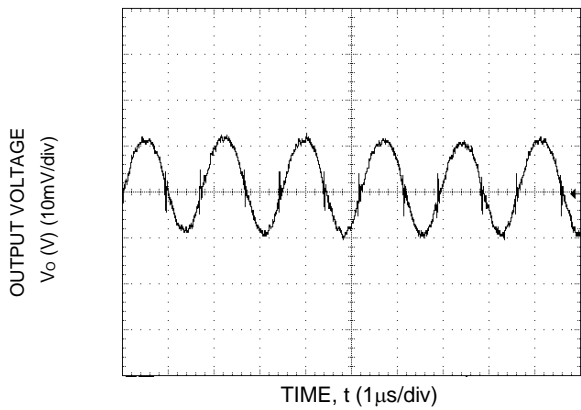

Figure 27. Typical output ripple and noise ($V_{IN} = 12V$, $I_o = I_{o,max}$).

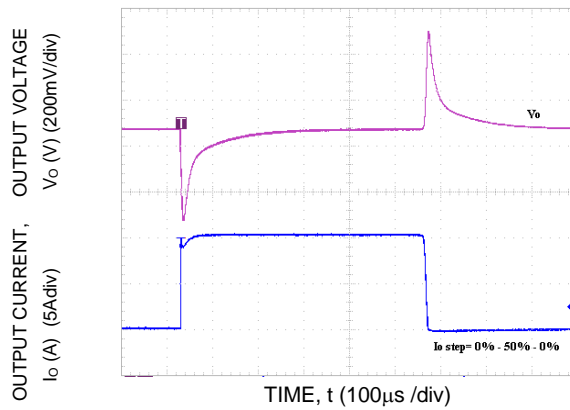

Figure 28. Transient Response to Dynamic Load Change from 0% to 50% to 0% with $V_{IN}=12V$.

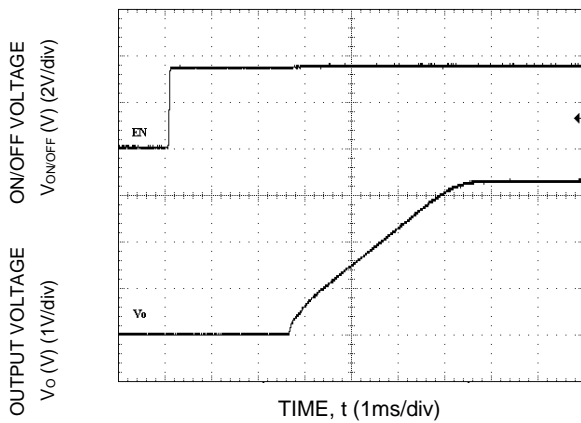

Figure 29. Typical Start-up Using On/Off Voltage ($I_o = I_{o,max}$).

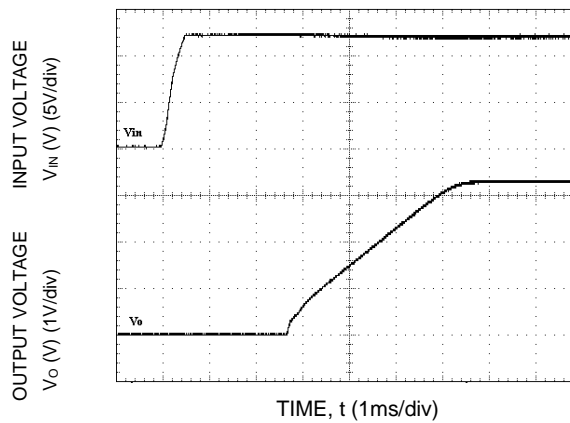

Figure 30. Typical Start-up Using Input Voltage ($V_{IN} = 12V$, $I_o = I_{o,max}$).

Naos Raptor 20A: Non-Isolated DC-DC Power Modules

4.5Vdc –14Vdc input; 0.59Vdc to 6Vdc output; 20A Output Current

Characteristic Curves (continued)

The following figures provide thermal derating curves for Naos Raptor 20A modules at 5V_{out} and 25°C.

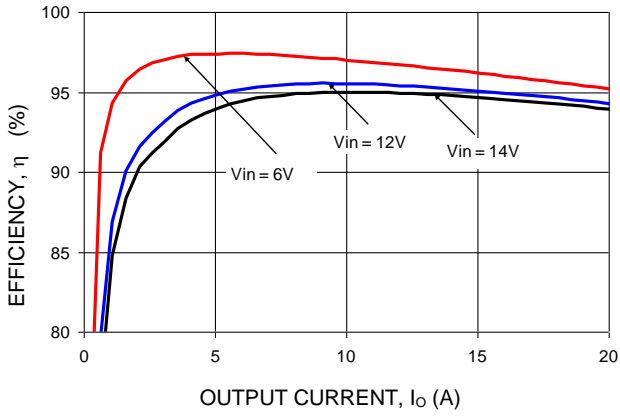

Figure 31. Converter Efficiency versus Output Current.

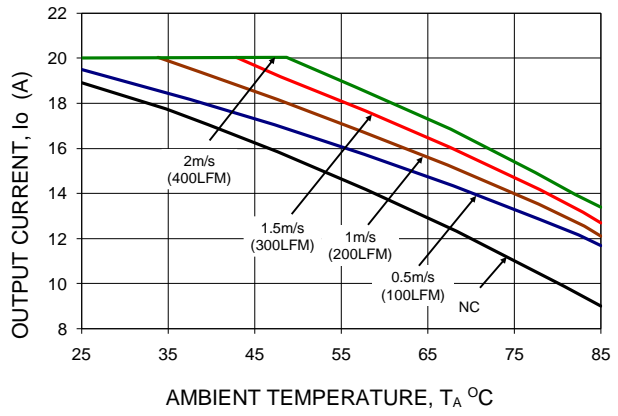

Figure 32. Derating Output Current versus Ambient Temperature and Airflow.

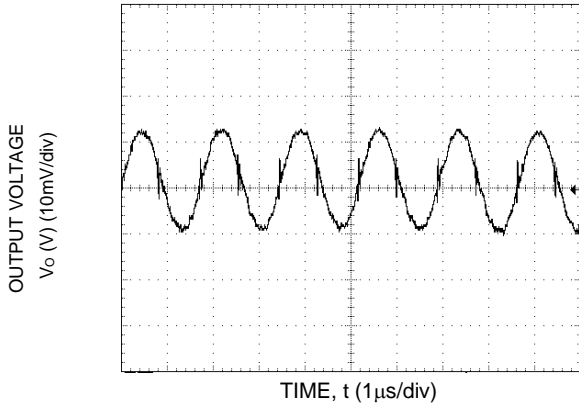

Figure 33. Typical output ripple and noise ($V_{IN} = 12V$, $I_o = I_{o,max}$).

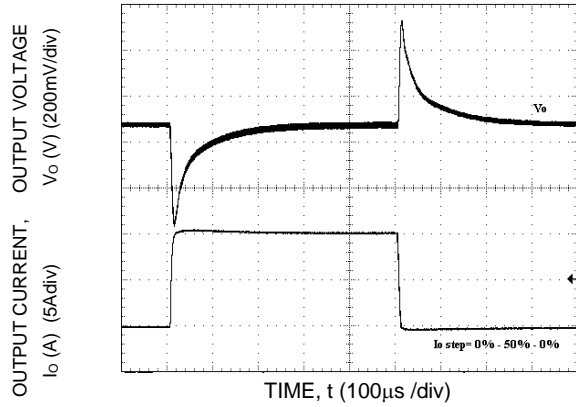

Figure 34. Transient Response to Dynamic Load Change from 0% to 50% to 0% with $V_{IN}=12V$.

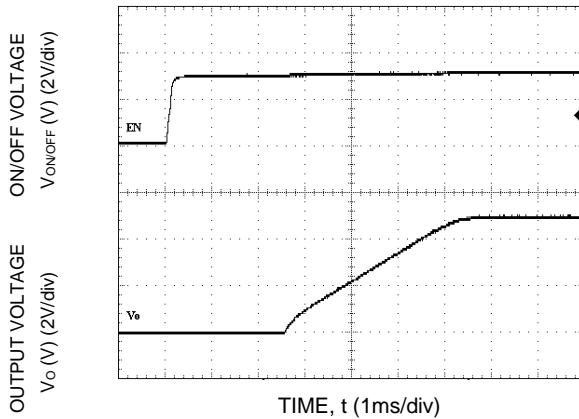

Figure 35. Typical Start-up Using On/Off Voltage ($I_o = I_{o,max}$).

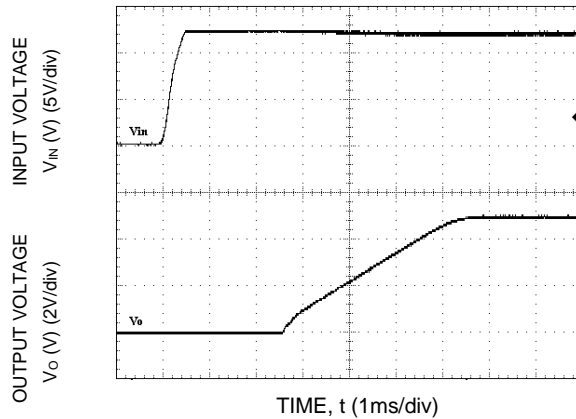

Figure 36. Typical Start-up Using Input Voltage ($V_{IN} = 12V$, $I_o = I_{o,max}$).

Naos Raptor 20A: Non-Isolated DC-DC Power Modules

4.5Vdc –14Vdc input; 0.59Vdc to 6Vdc output; 20A Output Current

Characteristic Curves (continued)

The following figures provide thermal derating curves for Naos Raptor 20A modules at 6Vout and 25°C.

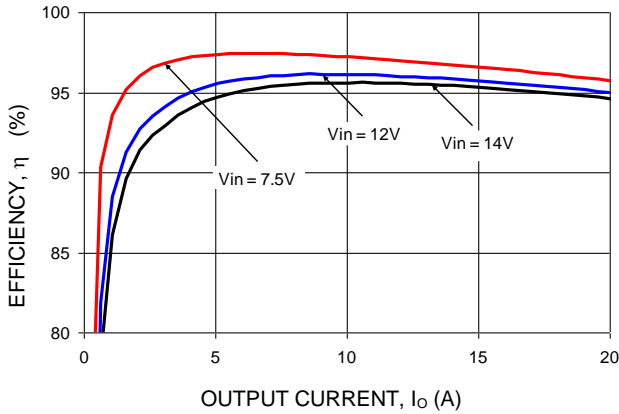

Figure 37. Converter Efficiency versus Output Current.

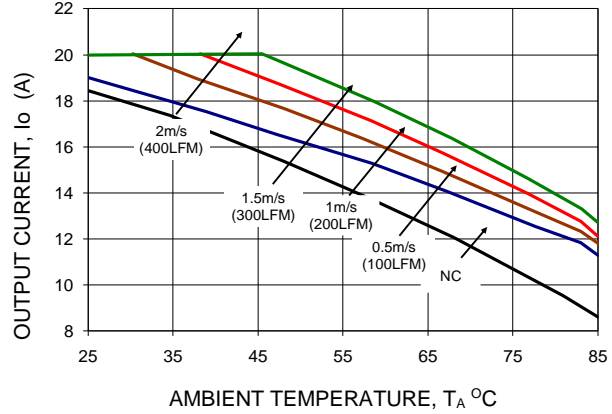

Figure 38. Derating Output Current versus Ambient Temperature and Airflow.

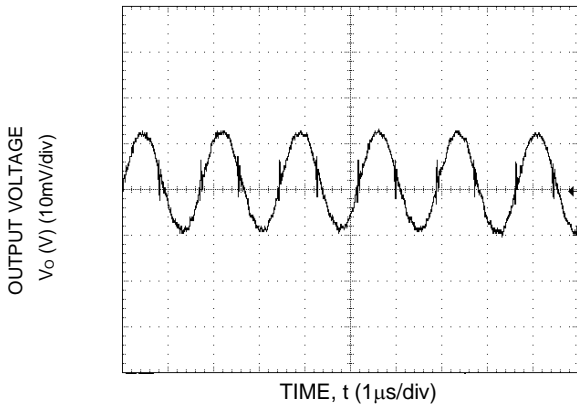

Figure 39. Typical output ripple and noise ($V_{IN} = 12V$, $I_o = I_{o,max}$).

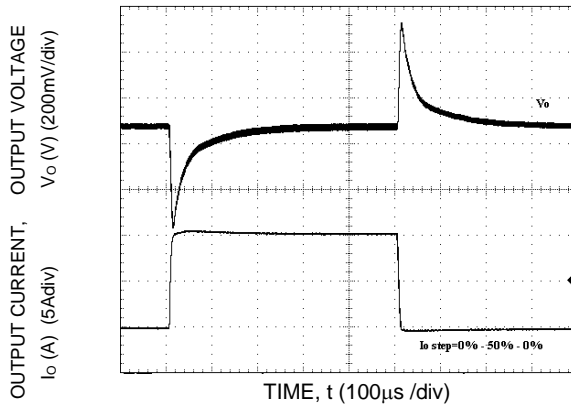

Figure 40. Transient Response to Dynamic Load Change from 0% to 50% to 0% with $V_{IN}=12V$.

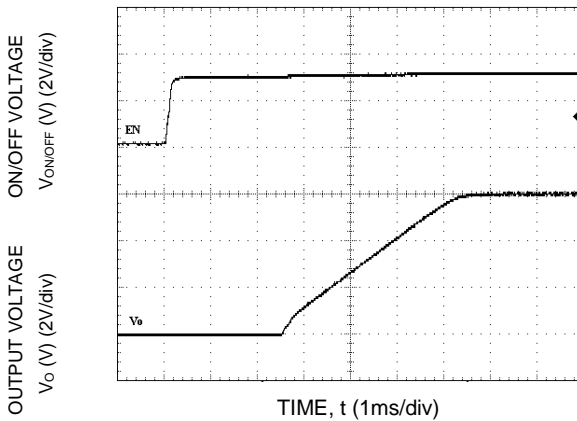

Figure 41. Typical Start-up Using On/Off Voltage ($I_o = I_{o,max}$).

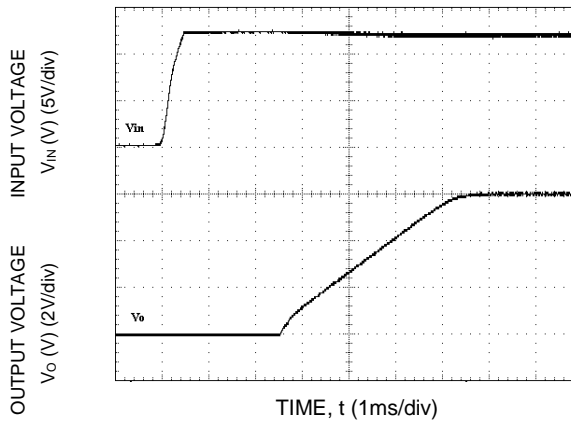
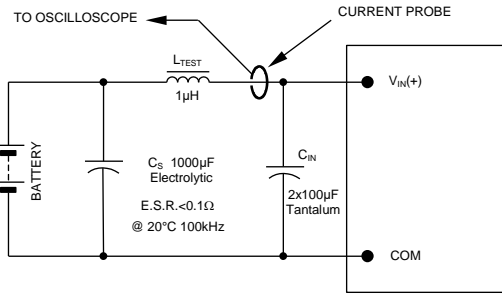

Figure 42. Typical Start-up Using Input Voltage ($V_{IN} = 12V$, $I_o = I_{o,max}$).

Naos Raptor 20A: Non-Isolated DC-DC Power Modules

4.5Vdc –14Vdc input; 0.59Vdc to 6Vdc output; 20A Output Current

Test Configurations



NOTE: Measure input reflected ripple current with a simulated source inductance (L_{TEST}) of 1µH. Capacitor C_S offsets possible battery impedance. Measure current as shown above.

Figure 43. Input Reflected Ripple Current Test Setup.

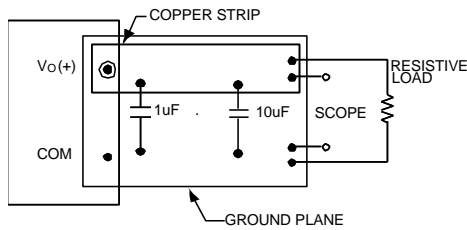

NOTE: All voltage measurements to be taken at the module terminals, as shown above. If sockets are used then Kelvin connections are required at the module terminals to avoid measurement errors due to socket contact resistance.

Figure 44. Output Ripple and Noise Test Setup.

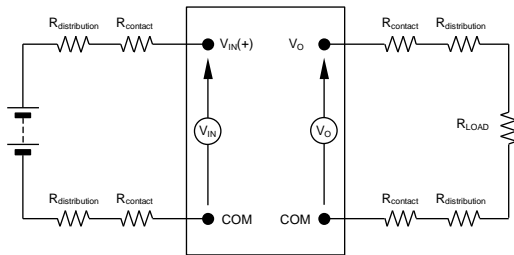

NOTE: All voltage measurements to be taken at the module terminals, as shown above. If sockets are used then Kelvin connections are required at the module terminals to avoid measurement errors due to socket contact resistance.

Figure 45. Output Voltage and Efficiency Test Setup.

$$\text{Efficiency } \eta = \frac{V_O \cdot I_O}{V_{IN} \cdot I_{IN}} \times 100 \%$$

Design Considerations

Input Filtering

The Naos Raptor 20A module should be connected to a low-impedance source. A highly inductive source can affect the stability of the module. An input capacitance must be placed directly adjacent to the input pin of the module, to minimize input ripple voltage and ensure module stability.

To minimize input voltage ripple, low-ESR ceramic or polymer capacitors are recommended at the input of the module. Figure 46 shows the input ripple voltage for various output voltages at 20A of load current with 2x22 µF or 4x22 µF ceramic capacitors and an input of 12V.

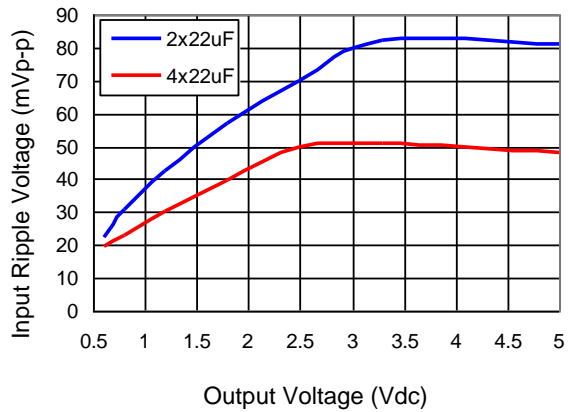

Figure 46. Input ripple voltage for various output voltages with 2x22 µF or 4x22 µF ceramic capacitors at the input (20A load). Input voltage is 12V.

Output Filtering

The Naos Raptor 20A modules are designed for low output ripple voltage and will meet the maximum output ripple specification with no external capacitors. However, additional output filtering may be required by the system designer for a number of reasons. First, there may be a need to further reduce the output ripple and noise of the module. Second, the dynamic response characteristics may need to be customized to a particular load step change.

To reduce the output ripple and improve the dynamic response to a step load change, additional capacitance at the output can be used. Low ESR ceramic and polymer are recommended to improve the dynamic response of the module. For stable operation of the module, limit the capacitance to less than the maximum output capacitance as specified in the electrical specification table. Optimal performance of the module can be achieved by using the Tunable Loop™ feature described later in this data sheet.

Naos Raptor 20A: Non-Isolated DC-DC Power Modules

4.5Vdc –14Vdc input; 0.59Vdc to 6Vdc output; 20A Output Current

Safety Considerations

For safety agency approval the power module must be installed in compliance with the spacing and separation requirements of the end-use safety agency standards, i.e., UL ANSI/UL 62368-1 and CAN/CSA C22.2 No. 62368-1 Recognized, DIN VDE 0868-1/A11:2017 (EN62368-1:2014/A11:2017)

For the converter output to be considered meeting the requirements of safety extra-low voltage (SELV) or ES1, the input must meet SELV/ES1 requirements. The power module has extra-low voltage (ELV) outputs when all inputs are ELV.

An input fuse for the module is recommended. Due to the wide input voltage and output voltage ranges of the module, different fuse ratings are recommended as shown in Table 1. These are suggested “maximum” fuse ratings. However, for optimum circuit protection, the fuse value should not be any larger than required in the end application. As an option to using a fuse, no fuse is required, if the module is

1. powered by a power source with current limit protection set point less than the protection device value listed in Table 1, and
2. the module is evaluated in the end-use equipment.

Table 1.

Input Voltage (VDC)	Output Voltage (VDC)			
	0.59 to 1.3	1.31 to 2.7	2.71 to 5.0	5.1 to 6
10.1 to 14	5A	10A	15A	20A
6.51 to 10	6.3A	15A	25A	30A
4.5 to 6.5	10A	20A	30A	NA

Feature Descriptions

Remote On/Off

The Naos Raptor 20A modules feature an On/Off pin with positive logic for remote On/Off operation. If not using the On/Off pin, leave the pin open (the module will be ON, except for the -49 option modules where leaving the pin open will cause the module to remain OFF). The On/Off signal ($V_{On/Off}$) is referenced to ground.

During a Logic High on the On/Off pin, the module remains ON. During Logic-Low, the module is turned OFF.

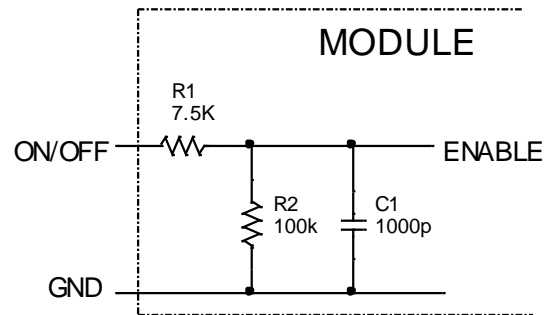

Figure 47. Remote On/Off Implementation. Components R2 and C1 are only present in the -49Z option module.

Overcurrent Protection

To provide protection in a fault (output overload) condition, the unit is equipped with internal current-limiting circuitry and can endure current limiting continuously. At the point of current-limit inception, the unit enters hiccup mode. The unit operates normally once the output current is brought back into its specified range. The typical average output current during hiccup is 10% of $I_{o,max}$.

Overtemperature Protection

To provide protection in a fault condition, these modules are equipped with a thermal shutdown circuit. The unit will shut down if the overtemperature threshold of 130°C is exceeded at the thermal reference point T_{ref} . The thermal shutdown is not intended as a guarantee that the unit will survive temperatures beyond its rating. Once the unit goes into thermal shutdown it will then wait to cool before attempting to restart.

Input Undervoltage Lockout

At input voltages below the input undervoltage lockout limit, module operation is disabled. The module will begin to operate at an input voltage above the undervoltage lockout turn-on threshold.

Feature Descriptions (continued)

Power Good

The Naos Raptor 20A modules provide a Power Good Status signal that indicates whether or not the power module is functioning properly.

PwGood is a power good signal implemented with an open-collector output to indicate that the output voltage is within the regulation limits of the power module. The PwGood signal will be de-asserted to a low state if any condition such as over-

Naos Raptor 20A: Non-Isolated DC-DC Power Modules

4.5Vdc –14Vdc input; 0.59Vdc to 6Vdc output; 20A Output Current

temperature, over-current, or over-voltage occurs which would result in the output voltage going out of range.

Output Voltage Programming

The output voltage of the Naos Raptor 20A module can be programmed to any voltage from 0.59Vdc to 6Vdc by connecting a resistor between the Trim+ and Trim– pins of the module. Certain restrictions apply on the output voltage set point depending on the input voltage. These are shown in the Output Voltage vs. Input Voltage Set Point Area plot in Fig. 48. The Upper Limit curve shows that for output voltages of 0.9V and lower, the input voltage must be lower than the maximum of 14V. The Lower Limit curve shows that for output voltages of 3.8V and higher, the input voltage needs to be larger than the minimum of 4.5V.

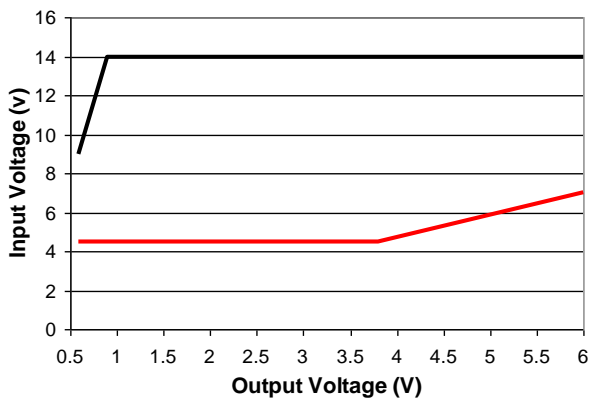

Figure 48. Output Voltage vs. Input Voltage Set Point Area plot showing limits where the output voltage can be set for different input voltages.

Without an external resistor between Trim+ and Trim– pins, the output of the module will be 0.59Vdc. To calculate the value of the trim resistor, *Rtrim* for a desired output voltage, use the following equation:

$$R_{trim} = \frac{1.182}{(V_o - 0.591)} k\Omega$$

Rtrim is the external resistor in kΩ

Vo is the desired output voltage

Table 2 provides *Rtrim* values required for some common output voltages.

Table 2

<i>V_{O, set}</i> (V)	<i>Rtrim</i> (KΩ)
0.59	Open
1.0	2.89
1.2	1.941
1.5	1.3
1.8	0.978
2.5	0.619
3.3	0.436
5.0	0.268
6.0	0.219

By using a ±0.5% tolerance trim resistor with a TC of ±25ppm, a set point tolerance of ±1.5% can be achieved as specified in

the electrical specification. The POL Programming Tool available at www.lineagepower.com under the Design Tools section, helps determine the required trim resistor needed for a specific output voltage.

Note: *V_{in}* ≥ 130% of *V_{out}* at the module output pin.

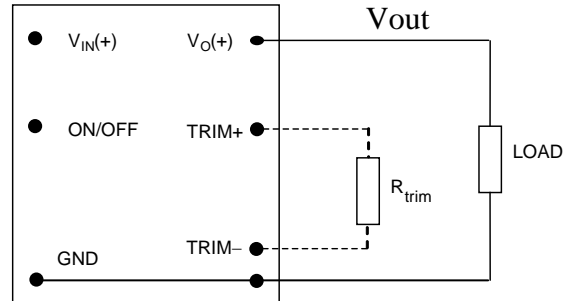

Figure 49. Circuit configuration for programming output voltage using an external resistor.

Voltage Margining

Output voltage margining can be implemented in the Naos Raptor 20A modules by connecting a resistor, *Rmargin-up*, from the Trim+ pin to the Trim– pin for margining-up the output voltage and by connecting a resistor, *Rmargin-down*, from the Trim+ pin to the output pin for margining-down. Figure 50 shows the circuit configuration for output voltage margining. The POL Programming Tool, available at www.lineagepower.com under the Design Tools section, also calculates the values of *Rmargin-up* and *Rmargin-down* for a specific output voltage and % margin. Please consult your local GE CRITICAL POWER technical representative for additional details.

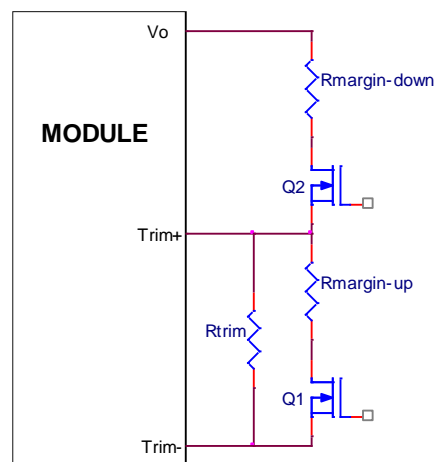

Figure 50. Circuit Configuration for margining Output voltage.

Naos Raptor 20A: Non-Isolated DC-DC Power Modules

4.5Vdc –14Vdc input; 0.59Vdc to 6Vdc output; 20A Output Current

Monotonic Start-up and Shutdown

The Naos Raptor 20A modules have monotonic start-up and shutdown behavior for any combination of rated input voltage, output current and operating temperature range.

Tunable Loop™

The Naos Raptor 20A modules have a new feature that optimizes transient response of the module called Tunable Loop™. External capacitors are usually added to improve output voltage transient response due to load current changes. Sensitive loads may also require additional output capacitance to reduce output ripple and noise. Adding external capacitance however affects the voltage control loop of the module, typically causing the loop to slow down with sluggish response. Larger values of external capacitance could also cause the module to become unstable.

To use the additional external capacitors in an optimal manner, the Tunable Loop™ feature allows the loop to be tuned externally by connecting a series R-C between the SENSE and TRIM pins of the module, as shown in Fig. 51. This R-C allows the user to externally adjust the voltage loop feedback compensation of the module to match the filter network connected to the output of the module.

Recommended values of R_{TUNE} and C_{TUNE} are given in Tables 3 and 4. Table 3 lists recommended values of R_{TUNE} and C_{TUNE} in order to meet 2% output voltage deviation limits for some common output voltages in the presence of a 5A to 10A step change (50% of full load), with an input voltage of 12V. Table 4 shows the recommended values of R_{TUNE} and C_{TUNE} for different values of ceramic output capacitors up to 1000uF, again for an input voltage of 12V. The value of R_{TUNE} should never be lower than the values shown in Tables 3 and 4. Please contact your GE CRITICAL POWER technical representative to obtain more details of this feature as well as for guidelines on how to select the right value of external R-C to tune the module for best transient performance and stable operation for other output capacitance values.

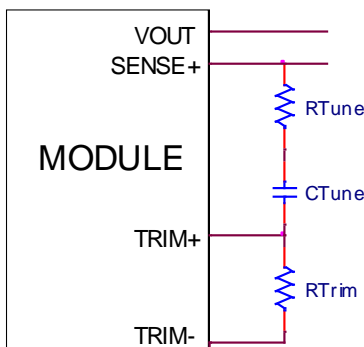

Figure 51. Circuit diagram showing connection of R_{TUNE} and C_{TUNE} to tune the control loop of the module.

Table 3. Recommended values of R_{TUNE} and C_{TUNE} to obtain transient deviation of 2% of V_{out} for a 10A step load with $V_{in}=12V$.

Vout	5V	3.3V	2.5V	1.8V	1.2V	0.69V
Cext	330µF Polymer	4x47µF + 330µF Polymer	2x47µF + 2x330µF Polymer	6x47µF + 3x330µF Polymer	7x330µF Polymer	23x330µF Polymer
R_{TUNE}	75	51	51	51	51	31
C_{TUNE}	100nF	150nF	220nF	330nF	330nF	330nF
ΔV	94mV	66mV	50mV	36mV	24mV	12mV

Table 4. General recommended values of R_{TUNE} and C_{TUNE} for $V_{in}=12V$ and various external ceramic capacitor combinations.

Cext	2x47µF	4x47µF	6x47µF	10x47µF	20x47µF	30x47µF
R_{TUNE}	75	75	75	51	51	51
C_{TUNE}	15nF	27nF	33nF	47nF	68nF	82nF

Naos Raptor 20A: Non-Isolated DC-DC Power Modules

4.5Vdc –14Vdc input; 0.59Vdc to 6Vdc output; 20A Output Current

Thermal Considerations

Power modules operate in a variety of thermal environments; however sufficient cooling should always be provided to help ensure reliable operation.

Considerations include ambient temperature, airflow, module power dissipation, and the need for increased reliability. A reduction in the operating temperature of the module will result in an increase in reliability. The thermal data presented here is based on physical measurements taken in a wind tunnel. The test set-up is shown in Figure 52. The preferred airflow direction for the module is in Figure 53.

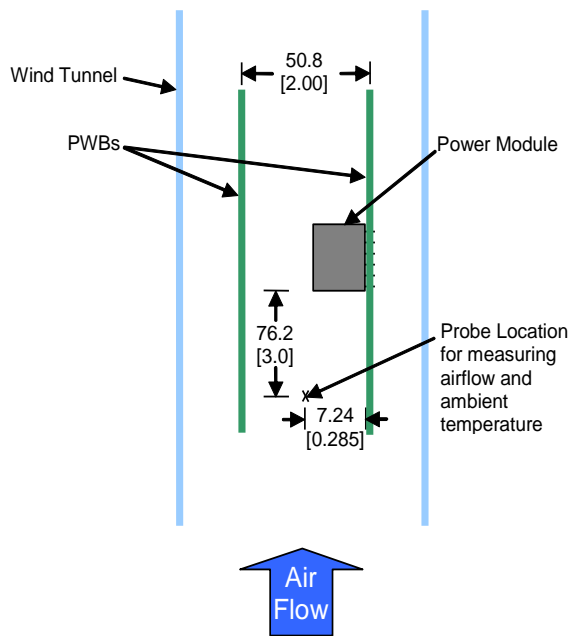

Figure 52. Thermal Test Set-up.

The thermal reference point, T_{ref} used in the specifications is shown in Figure 53. For reliable operation this temperatures should not exceed 122°C.

The output power of the module should not exceed the rated power of the module ($V_{o,set} \times I_{o,max}$).

Please refer to the Application Note “Thermal Characterization Process For Open-Frame Board-Mounted Power Modules” for a detailed discussion of thermal aspects including maximum device temperatures.

Mechanical Outline

Dimensions are in inches and (millimeters).

Tolerances: x.x mm ± 0.5 mm (x.xx in. ± 0.02 in.) [unless otherwise indicated]

x.xx mm ± 0.25 mm (x.xxx in. ± 0.010 in.)

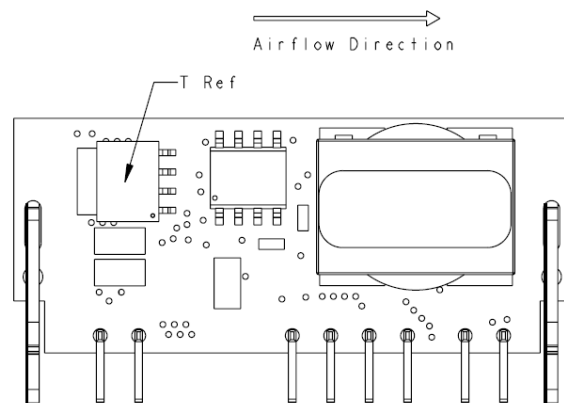

Figure 53. Temperature measurement location T_{ref} .

Heat Transfer via Convection

Increased airflow over the module enhances the heat transfer via convection. Thermal derating curves showing the maximum output current that can be delivered at different local ambient temperatures (T_A) for airflow conditions ranging from natural convection and up to 2m/s (400 ft./min) are shown in the Characteristics Curves section.

Post solder Cleaning and Drying Considerations

Post solder cleaning is usually the final circuit-board assembly process prior to electrical board testing. The result of inadequate cleaning and drying can affect both the reliability of a power module and the testability of the finished circuit-board assembly. For guidance on appropriate soldering, cleaning and drying procedures, refer to *Board Mounted Power Modules: Soldering and Cleaning* Application Note.

Through-Hole Lead-Free Soldering Information

These RoHS-compliant through-hole products use the SAC (Sn/Ag/Cu) Pb-free solder and RoHS-compliant components. They are designed to be processed through single or dual wave soldering machines. The pins have an RoHS-compliant finish that is compatible with both Pb and Pb-free wave soldering processes. A maximum preheat rate of 3°C/s is suggested. The wave preheat process should be such that the temperature of the power module board is kept below 210°C. For Pb solder, the recommended pot temperature is 260°C, while the Pb-free solder pot is 270°C max. Not all RoHS-compliant through-hole products can be processed with paste-through-hole Pb or Pb-free reflow process. If additional information is needed, please consult with your GE CRITICAL POWER technical representative for more details.

Naos Raptor 20A: Non-Isolated DC-DC Power Modules

4.5Vdc –14Vdc input; 0.59Vdc to 6Vdc output; 20A Output Current

Front View

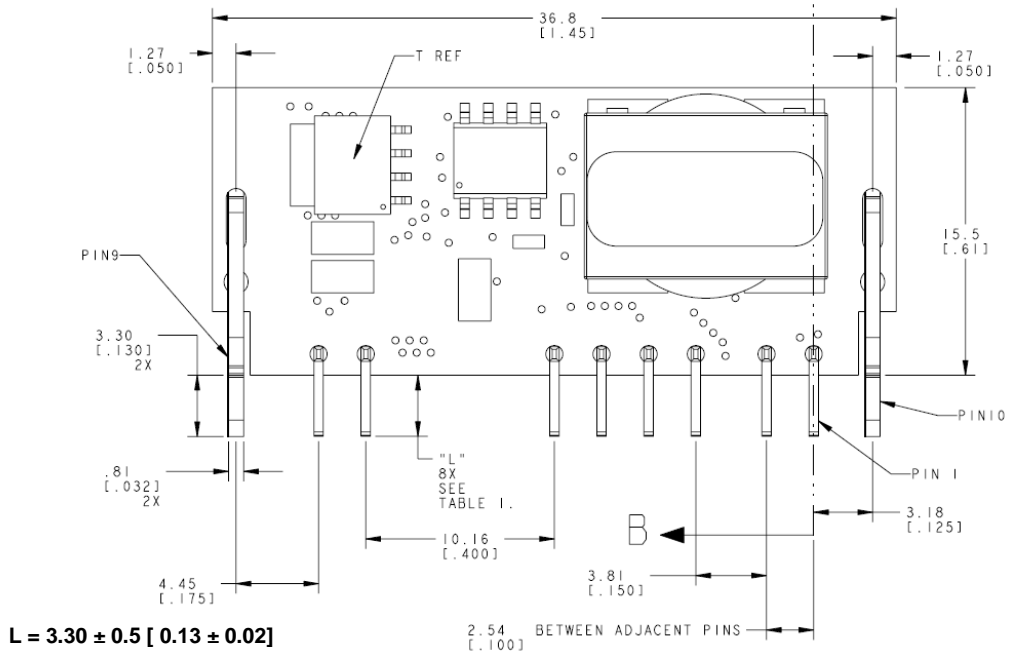

Side View

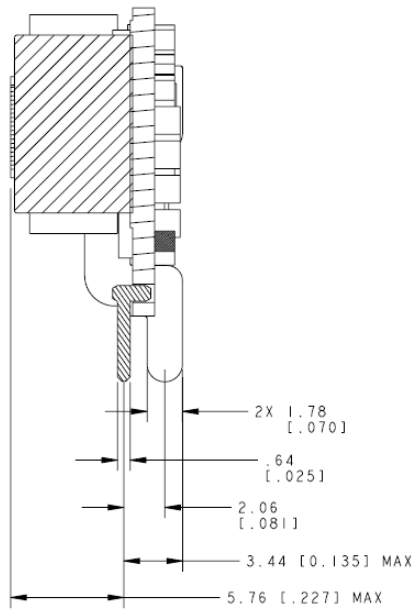

Pin out

Pin	Function	Pin	Function
1	V _{out}	6	V _{in}
2	Trim +	7	Sense +
3	GND	8	Sense -
4	PwGood	9	TRIM -
5	On/Off	10	GND

Naos Raptor 20A: Non-Isolated DC-DC Power Modules

4.5Vdc –14Vdc input; 0.59Vdc to 6Vdc output; 20A Output Current

Mechanical Outline - No Outrigger pins (-Y version)

Dimensions are in inches and (millimeters).

Tolerances: x.x mm ± 0.5 mm (x.xx in. ± 0.02 in.) [unless otherwise indicated]

x.xx mm ± 0.25 mm (x.xxx in ± 0.010 in.)

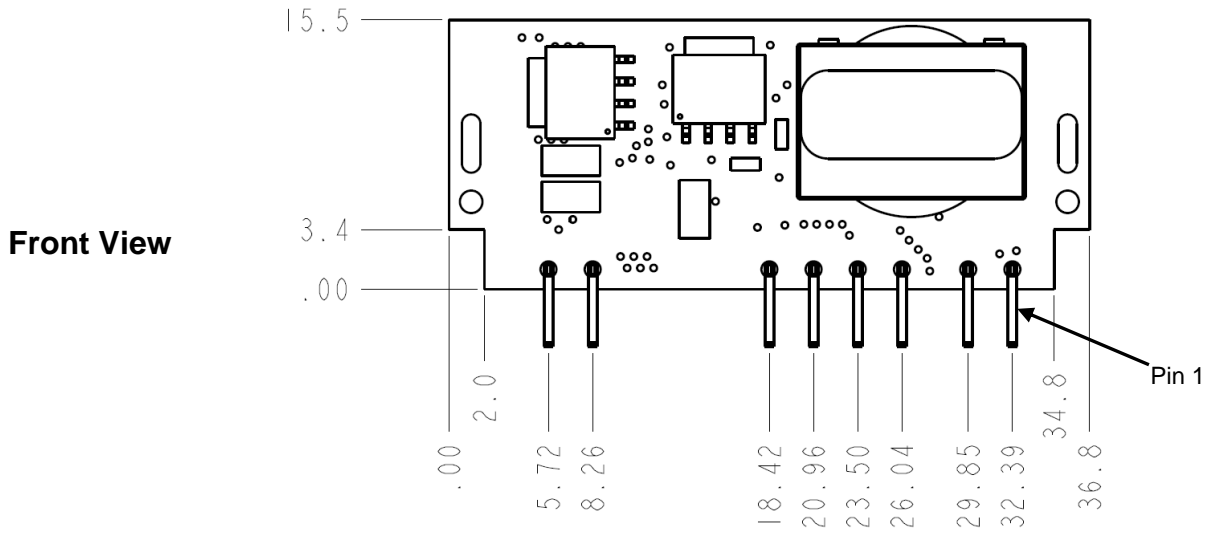

$L = 3.30 \pm 0.5 [0.13 \pm 0.02]$

Side View

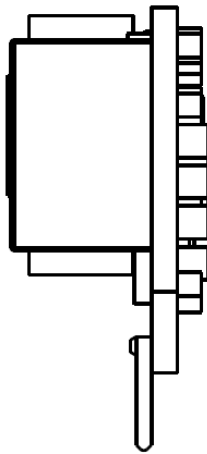

Pin out

Pin	Function	Pin	Function
1	V _{out}	6	V _{in}
2	Trim +	7	Sense +
3	GND	8	Sense -
4	PwGood		
5	On/Off		

Naos Raptor 20A: Non-Isolated DC-DC Power Modules

4.5Vdc –14Vdc input; 0.59Vdc to 6Vdc output; 20A Output Current

Recommended Pad Layout

Dimensions are in millimeters and (inches).

Tolerances: x.x mm ± 0.2 mm (x.xx in. ± 0.02 in.) [unless otherwise indicated]

x.xx mm ± 0.12 mm (x.xxx in ± 0.005 in.)

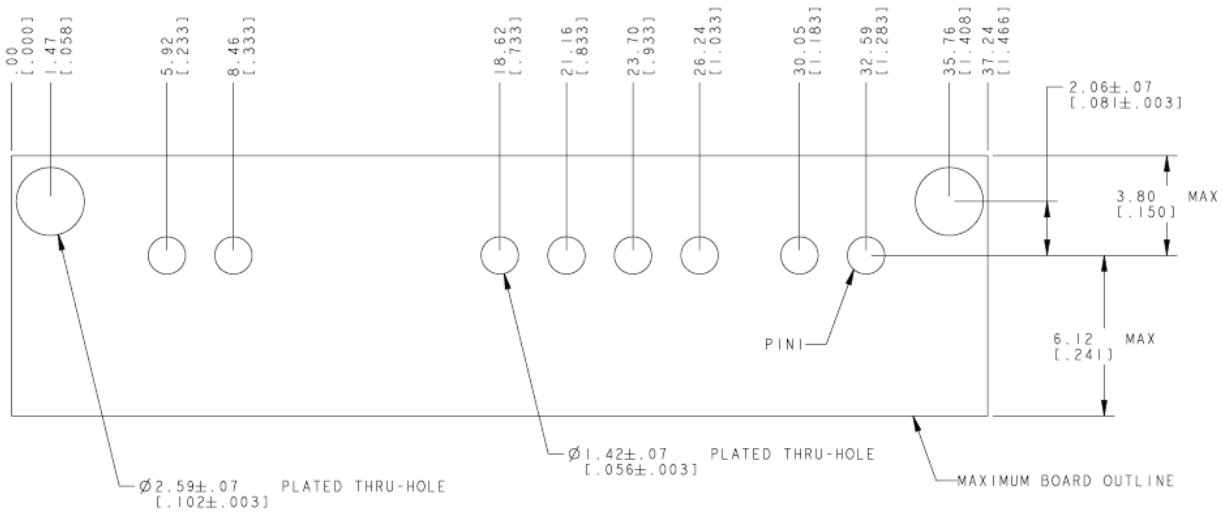

Pin	Function	Pin	Function
1	V _{out}	6	V _{in}
2	Trim +	7	Sense +
3	GND	8	Sense -
4	PwGood	9	TRIM -
5	On/Off	10	GND

No Outrigger pins (–

Y version)

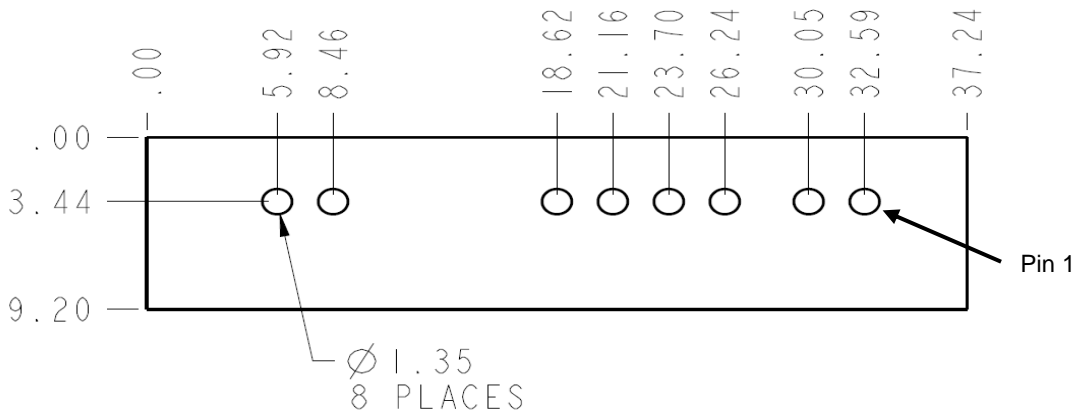

Pin	Function	Pin	Function
1	V _{out}	6	V _{in}
2	Trim +	7	Sense +
3	GND	8	Sense -
4	PwGood		
5	On/Off		

Naos Raptor 20A: Non-Isolated DC-DC Power Modules

4.5Vdc –14Vdc input; 0.59Vdc to 6Vdc output; 20A Output Current

Ordering Information

Please contact your GE CRITICAL POWER Sales Representative for pricing, availability and optional features.

Table 5. Device Codes

Device Code	Input Voltage Range	Output Voltage	Output Current	On/Off Logic	Connector Type	Comcode
NSR020A0X43Z	4.5 – 13.8Vdc	0.59 – 6Vdc	20 A	Positive	SIP	CC109130911
NSR020A0X43-YZ	4.5 – 13.8Vdc	0.59 – 6Vdc	20 A	Positive	SIP	CC109156106

Table 6. Coding Scheme

Series generation	Output Current	Output voltage	Pin Length	On / Off logic	Sense	Default On/Off Condition	Options	ROHS Compliance
NSR	020A0	X		4	3			Z
	020A0 = 20A	X = programmable output	Blank = Standard 5=5.1mm 6=3.7mm 8=2.8mm	4 = positive No entry = negative	3 = Remote Sense Blank= without	Blank = Standard, ON when unconnected 2=Inverted On/Off	-Y = without outrigger pins	Z = ROHS6

Contact Us

For more information, call us at

USA/Canada:

+1 877 546 3243, or +1 972 244 9288

Asia-Pacific:

+86-21-53899666

Europe, Middle-East and Africa:

+49.89.878067-280

[Go.ABB/Industrial](#)



GE Critical Power reserves the right to make changes to the product(s) or information contained herein without notice, and no liability is assumed as a result of their use or application. No rights under any patent accompany the sale of any such product(s) or information.