

LOC		DIST		REVISIONS			
				REV	PER	DATE	BY
		F		REV PER ECO	14-003443	3-21-14	CT

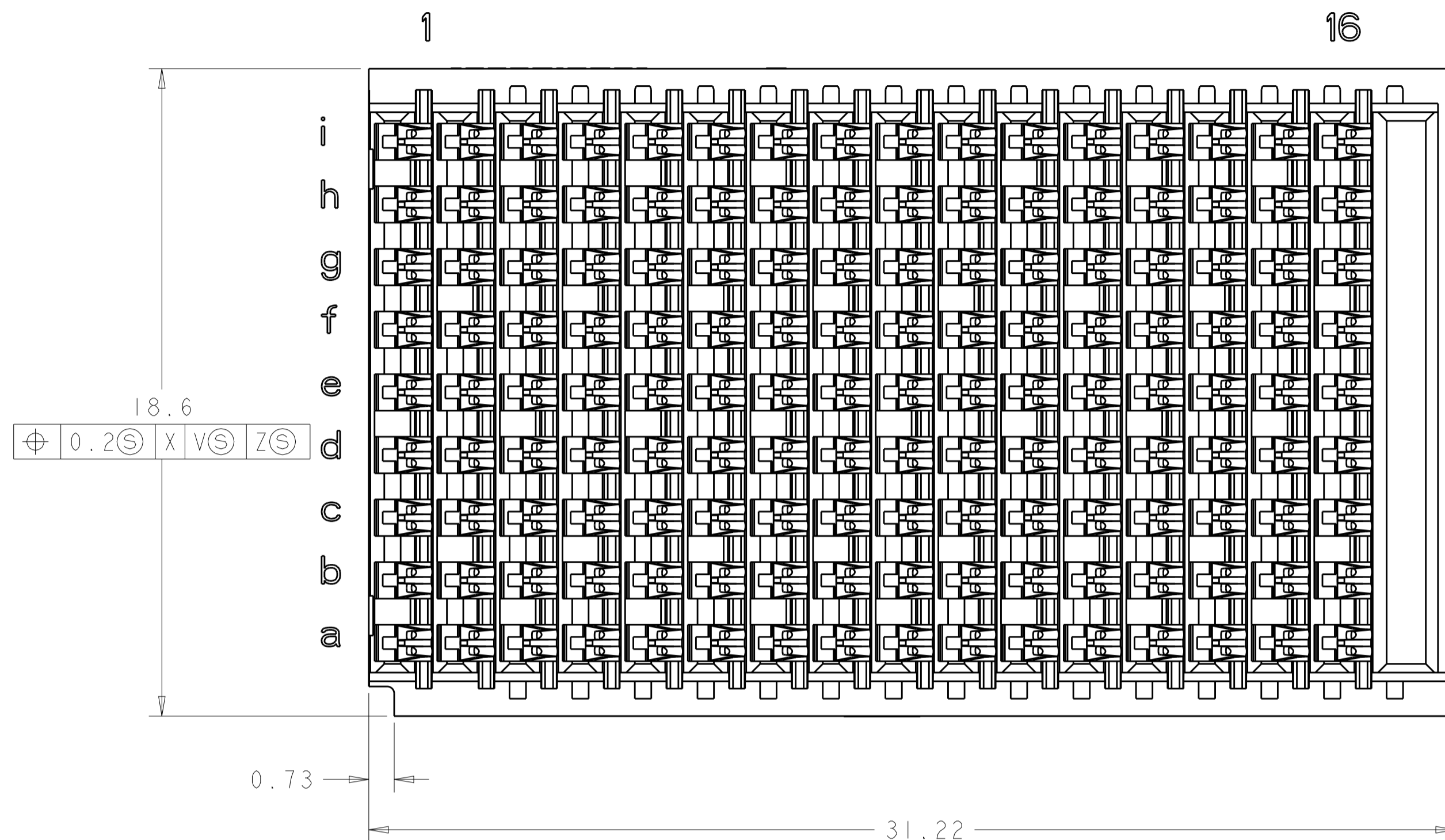

- △ HOUSING: LCP, UL94V0, COLOR: BLACK. CONTACT: PHOSPHOR BRONZE.
- △ FINISH: 1.27µm GOLD IN CONTACT AREA 1.27µm MIN. TIN-LEAD ON PCB TAIL OVER 3.81µm MIN. NICKEL OVER ALL.
- △ FINISH: 1.27µm GOLD IN CONTACT AREA 1.27µm MIN. TIN ON PCB TAIL OVER 3.81µm MIN. NICKEL OVER ALL.
- △ PLATE THROUGH HOLE PER TE SPEC. 114-13056 FIGURE 4.
- △ ADDITIONAL CONNECTOR-SIDE KEEPOUT AREA REQUIRED IF CONNECTOR-SIDE EXTRACTION TOOL IS TO BE USED.
- △ PLASTIC ALIGNMENT PIN MUST BE REMOVED FLUSH TO HOUSING BODY PRIOR TO INSERTION INTO RTM LAYOUT

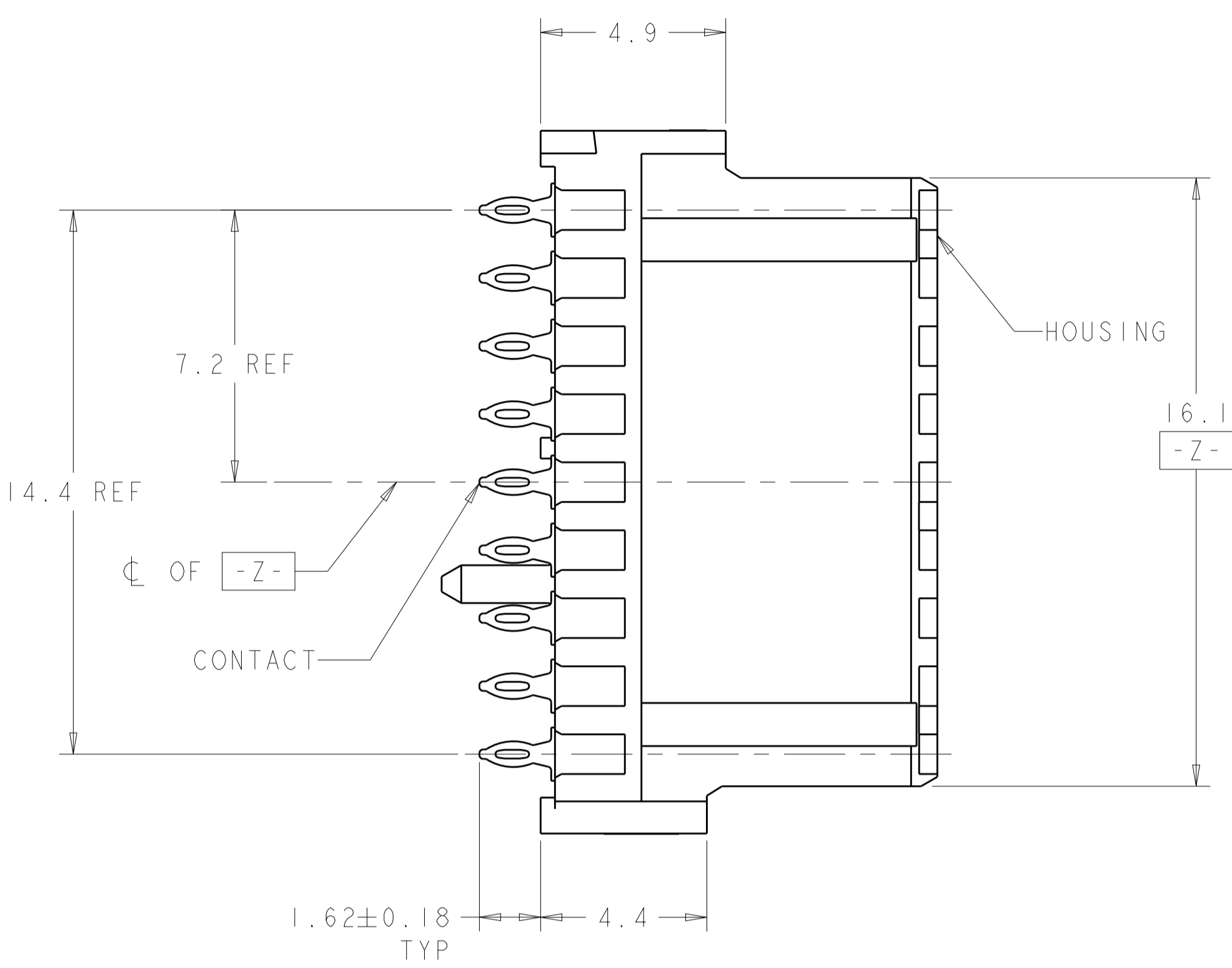
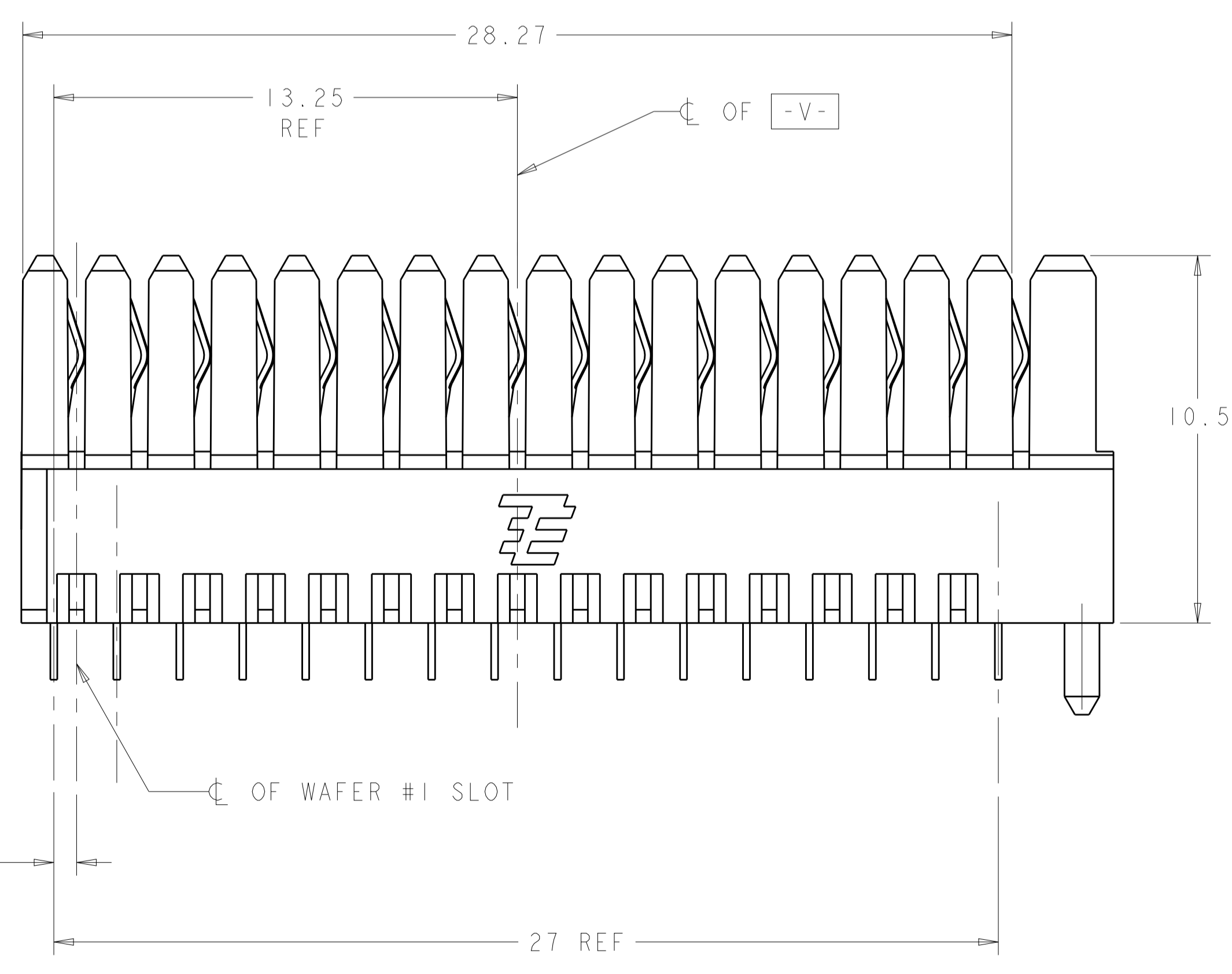
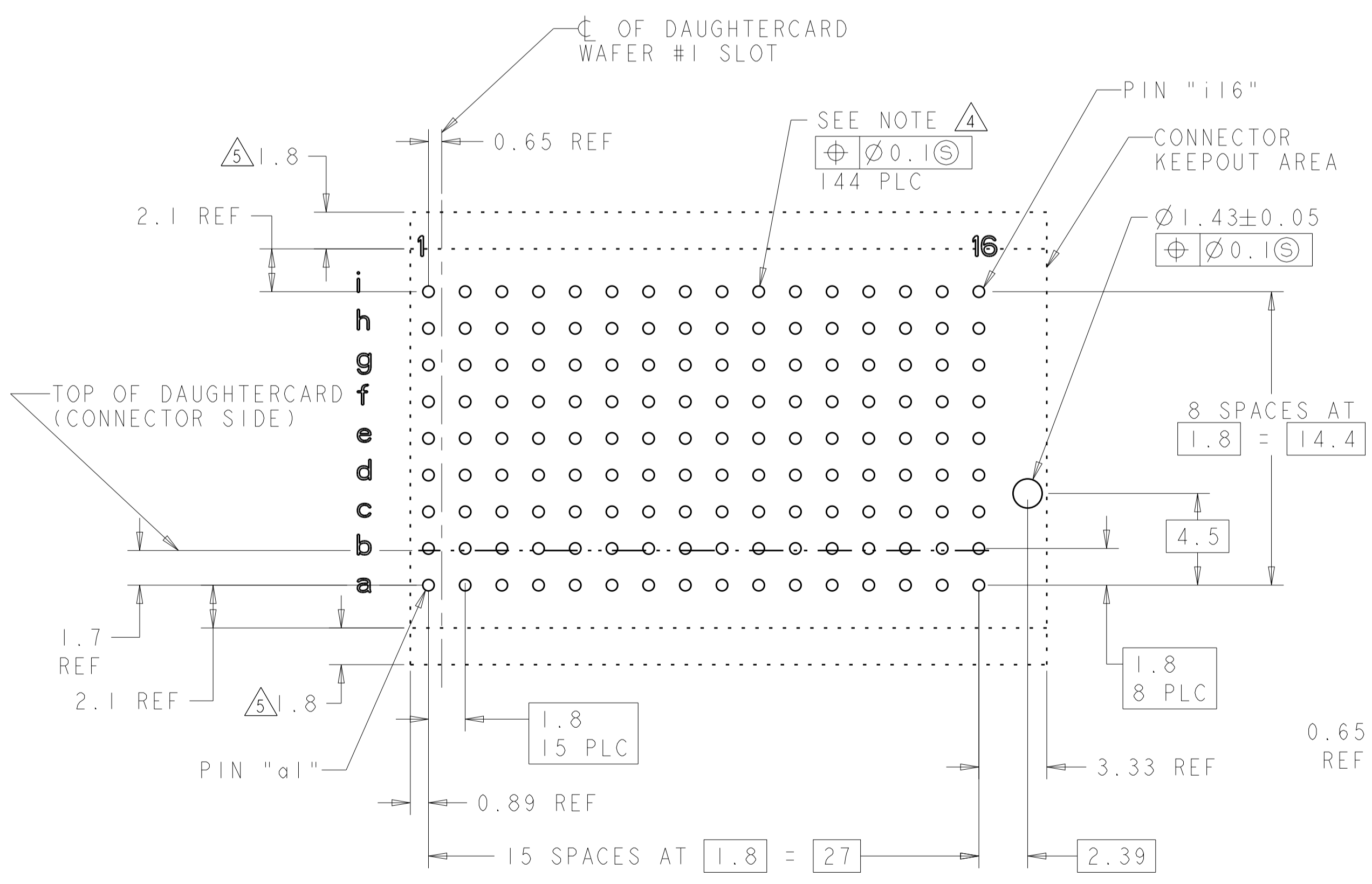

PC BOARD LAYOUT (CONNECTOR SIDE)  
(SEE SHEET 2 FOR RTM)  
SCALE 5:1

△ 3	1410142-2
△ 2	1410142-1
PLATING	PART NO

THIS DRAWING IS A CONTROLLED DOCUMENT.		OWN: R. TREA 13NOV2002	TE Connectivity
DIMENSIONS: mm		CHK: J. CONSOLI 18NOV2002	
TOLERANCES UNLESS OTHERWISE SPECIFIED:		APVD: 18NOV2002	
0 PLC ±0.5	1 PLC ±0.13	PRODUCT SPEC 108-2072	NAME: CONNECTOR ASSEMBLY, BACKPLANE VERTICAL RECEPTACLE, RIGHT END, 20.3mm, MultiGig RT 2
2 PLC ±0.13	3 PLC ±0.13	APPLICATION SPEC 114-13056	SIZE: CAGE CODE DRAWING NO. RESTRICTED TO
4 PLC ±0.13	5 PLC ±0.13	WEIGHT: -	A100779C=1410142
ANGLES ±1°	FINISH SEE TABLE	CUSTOMER DRAWING	SCALE 8:1 SHEET 1 OF 2 REV F

LOC		DIST		REVISIONS			
P	LTN	DESCRIPTION	DATE	DMN	APVD		
-	-	SEE SHEET 1	-	-	-		

# REAR TRANSITION MODULE APPLICATION

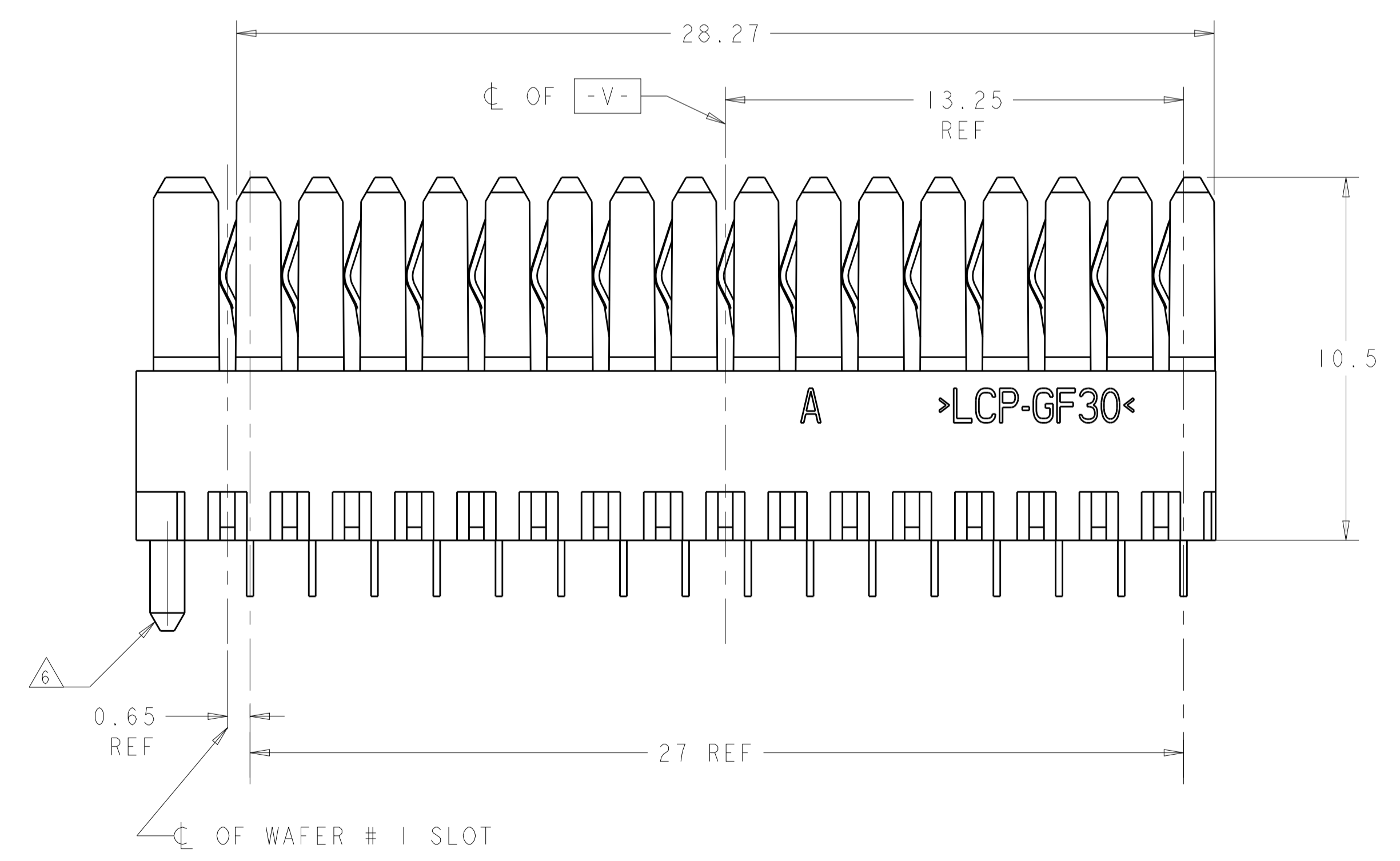
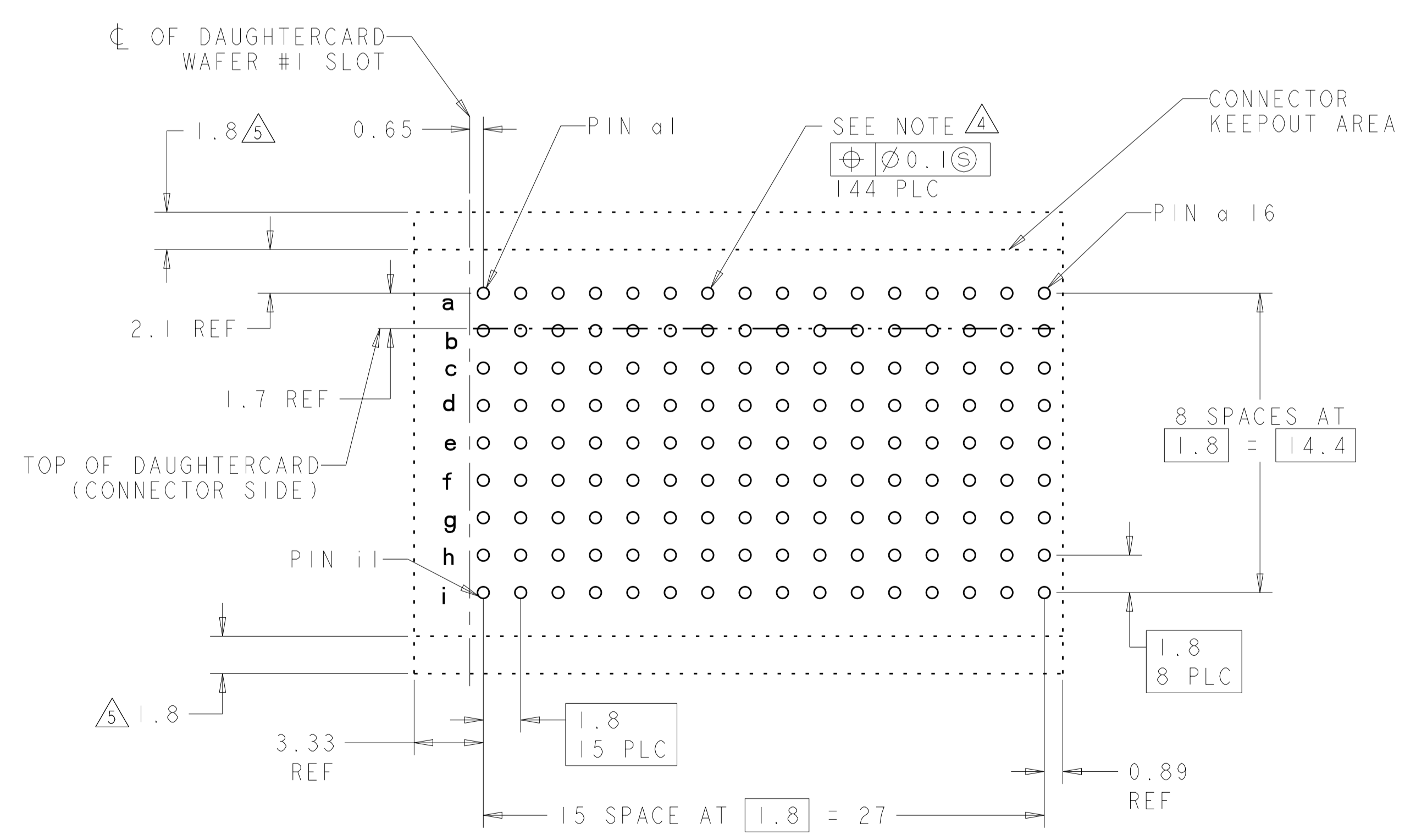
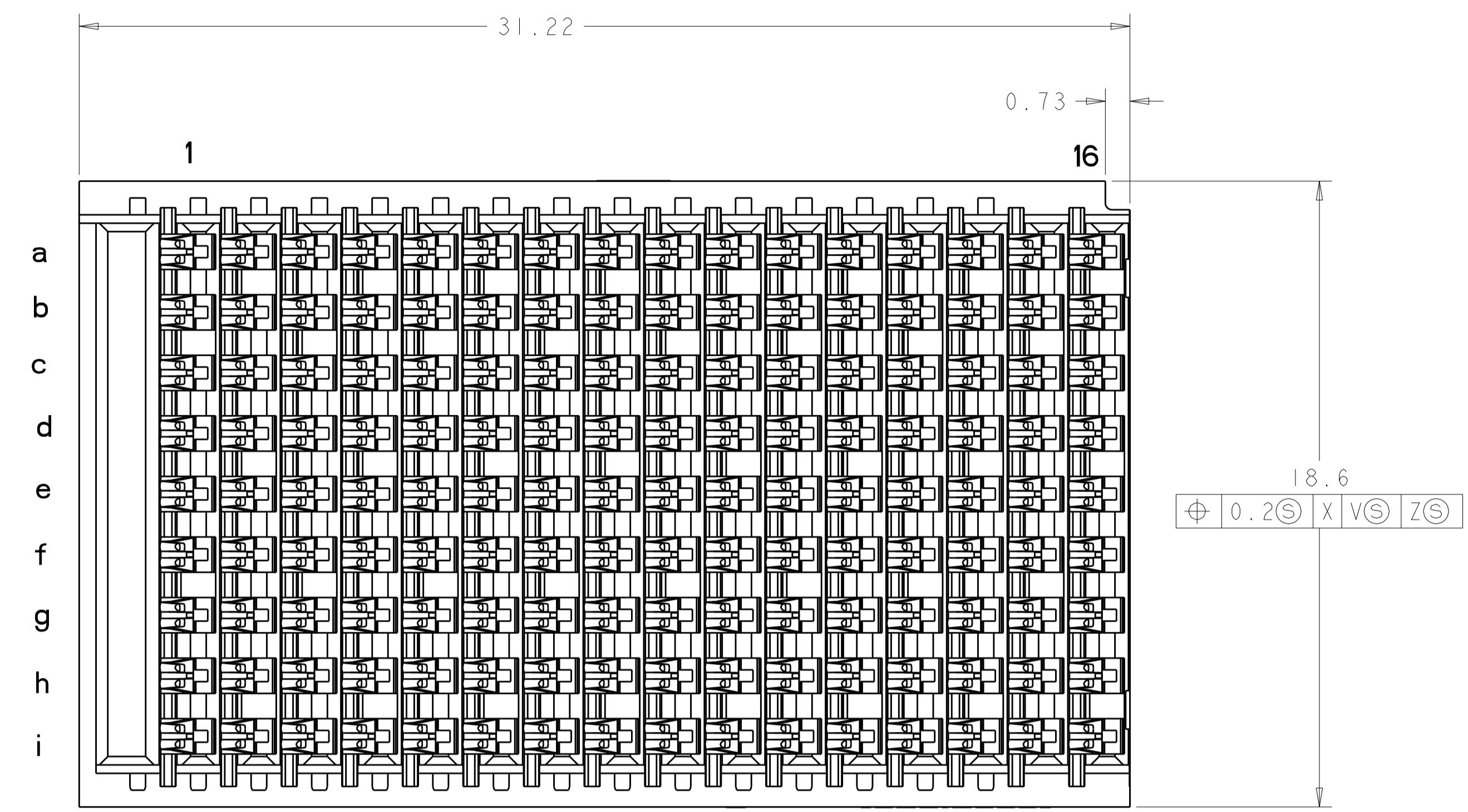
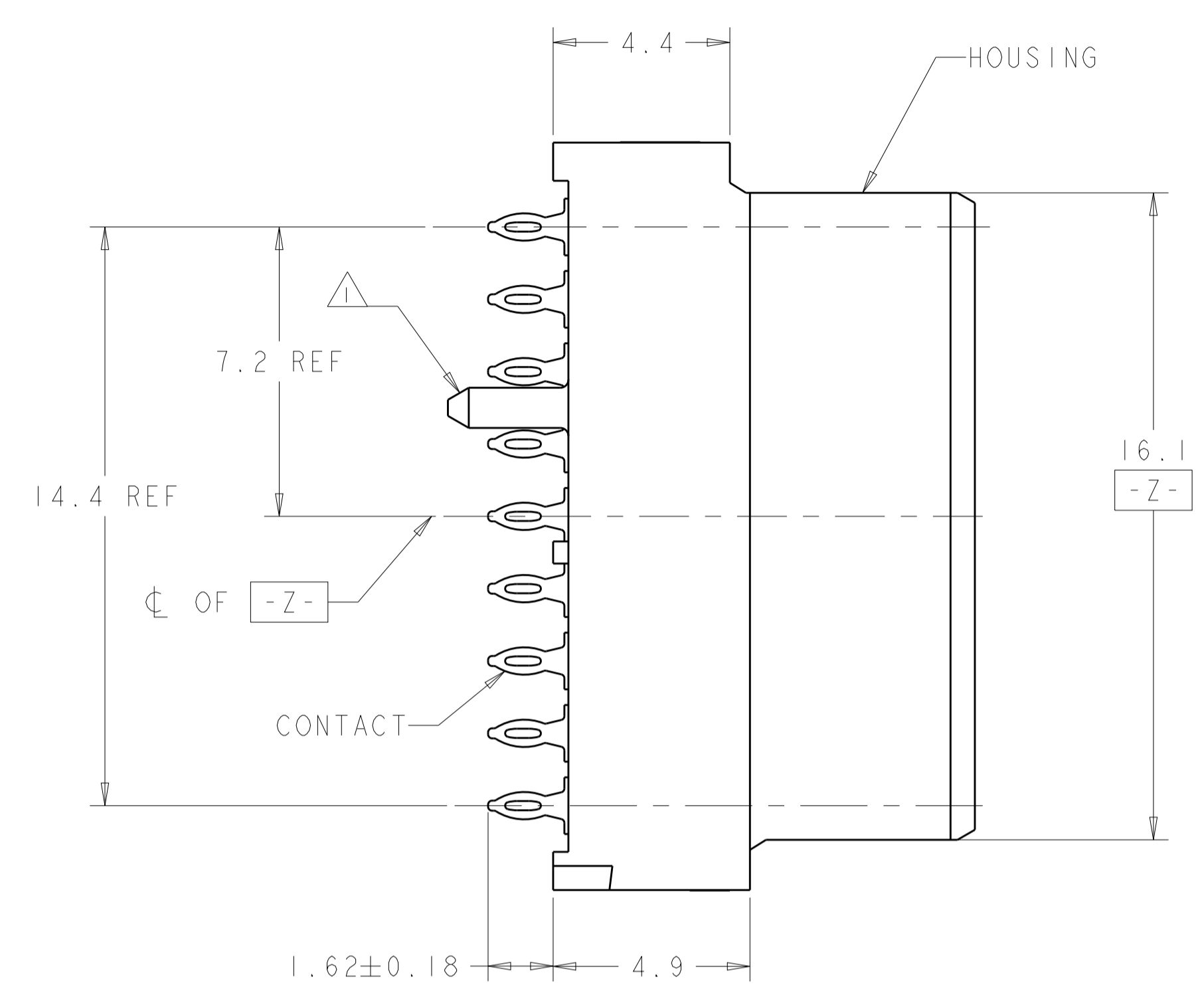

PC BOARD REAR TRANSITION MODULE (CONNECTOR SIDE) SCALE 5:1

THIS DRAWING IS A CONTROLLED DOCUMENT.		DMN: R. TREA 13NOV2002	 TE Connectivity
DIMENSIONS: mm		CHK: J. CONSOLI 18NOV2002	
 TOLERANCES UNLESS OTHERWISE SPECIFIED:		APVD: J. CONSOLI 18NOV2002	
0 PLC ±0.5 1 PLC ±0.5 2 PLC ±0.13 3 PLC ±0.13 4 PLC ±0.13 ANGLES ±1°		PRODUCT SPEC: 108-2072	NAME: CONNECTOR ASSEMBLY, BACKPLANE VERTICAL RECEPTACLE, RIGHT END, 20.3mm, MultiGig RT 2
MATERIAL: SEE TABLE		APPLICATION SPEC: 114-13056	SIZE: A100779
		WEIGHT: -	CAGE CODE: 1410142
		CUSTOMER DRAWING	RESTRICTED TO: -
		SCALE: 8:1	SHEET: 2 OF 2
			REV: F