

REFERENCE
SPEC. No. ED-03G038B
ISSUE September 14, 2005

SHARP

OPTO-ELECTRONIC DEVICES DIVISION
ELECTRONIC COMPONENTS GROUP
SHARP CORPORATION

SPECIFICATION

DEVICE SPECIFICATION FOR

MODEL No. PHOTOINTERRUPTER

GP1S093HCZ0F

Specified for _____

Enclosed please find copies of the Specifications which consists of 10 pages including cover.
After confirmation of the contents, please be sure to send back copies of the Specifications
with approving signature on each.

CUSTOMER'S APPROVAL

DATE

BY

PRESENTED

DATE

BY H. O

H. Ogura,
Department General Manager of
Engineering Dept., III
Opto-Electronic Devices Div.
ELECOM Group
SHARP CORPORATION

Product name : PHOTOINTERRUPTER

Model No. : GP1S093HCZ0F

1. These specification sheets include materials protected under copyright of Sharp Corporation ("Sharp"). Please do not reproduce or cause anyone to reproduce them without Sharp's consent.
2. When using this product, please observe the absolute maximum ratings and the instructions for use outlined in these specification sheets, as well as the precautions mentioned below. Sharp assumes no responsibility for any damage resulting from use of the product which does not comply with the absolute maximum ratings and the instructions included in these specification sheets, and the precautions mentioned below.

(Precautions)

- (1) This product is designed for use in the following application areas ;

| | | |
|--|--|---|
| <ul style="list-style-type: none"> • OA equipment • Telecommunication equipment (Terminal) • Tooling machines | <ul style="list-style-type: none"> • Audio visual equipment • Measuring equipment • Computers | <ul style="list-style-type: none"> • Home appliances |
|--|--|---|

If the use of the product in the above application areas is for equipment listed in paragraphs (2) or (3), please be sure to observe the precautions given in those respective paragraphs.

- (2) Appropriate measures, such as fail-safe design and redundant design considering the safety design of the overall system and equipment, should be taken to ensure reliability and safety when this product is used for equipment which demands high reliability and safety in function and precision, such as ;

| | | |
|---|---|---|
| <ul style="list-style-type: none"> • Transportation control and safety equipment (aircraft, train, automobile etc.) • Traffic signals • Other safety equipment | <ul style="list-style-type: none"> • Gas leakage sensor breakers | <ul style="list-style-type: none"> • Rescue and security equipment |
|---|---|---|

- (3) Please do not use this product for equipment which require extremely high reliability and safety in function and precision, such as ;

| | |
|--|--|
| <ul style="list-style-type: none"> • Space equipment • Nuclear power control equipment | <ul style="list-style-type: none"> • Telecommunication equipment (for trunk lines) • Medical equipment |
|--|--|

- (4) Please contact and consult with a Sharp sales representative if there are any questions regarding interpretation of the above three paragraphs.

3. Please contact and consult with a Sharp sales representative for any questions about this product.

1. Application

This specification applies to the outline and characteristics of transmissive type photointerrupter; Model No. GP1S093HCZ0F.

- 2. Outline : Refer to the attached drawing No. CY10872i02.
- 3. Ratings and characteristics : Refer to the attached sheet, Page 4, 5.
- 4. Reliability : Refer to the attached sheet, Page 6.
- 5. Outgoing inspection : Refer to the attached sheet, Page 7.
- 6. Supplements

- 6.1 Parts : Refer to the attached sheet, Page 8.
- 6.2 Packing : Refer to the attached drawing No. SOE001327.
- 6.3 ODS materials

This product shall not contain the following materials.
 Also, the following materials shall not be used in the production process for this product.
 Materials for ODS : CFCs, Halon, Carbon tetrachloride, 1,1,1-Trichloroethane (Methyl chloroform)

- 6.4 Brominated flame retardants
Specific brominated flame retardants such as the PBBO_S and PBB_S are not used in this device at all.
- 6.5 RoHS restriction
This product corresponds to the RoHS directive.
- 6.6 Product mass : Approx. 50mg

7. Notes

- 1) Circuit design
In circuit designing, make allowance for the degradation of the light emitting diode output that results from long continuous operation. (50% degradation/5 years)
- 2) Prevention of faulty operation
To prevent photointerrupter from faulty operation caused by external light, do not set the detecting face to the external light.
- 3) Position of opaque board
Opaque board shall be installed at place 1.6mm or more from the top of elements.
(Example)

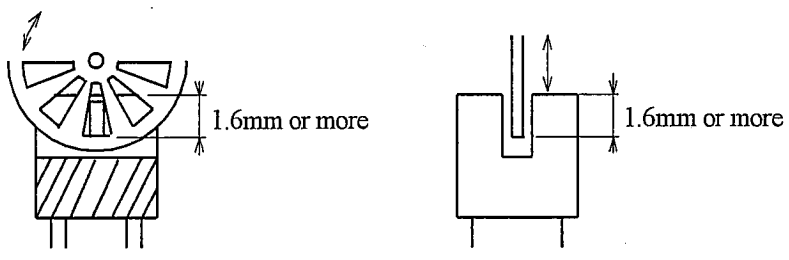

4) Soldering

To solder onto lead pins, solder at the position of 1mm or more from the package's bottom at 260°C for 5 s or less.
 Please don't bend lead pins from the root of package when soldering.
 And please take care not to let any external force exert on lead pins.
 Please don't do soldering with preheating, and please don't do soldering by reflow.

5) Cleaning

Cleaning shall be carried out as below to avoid remaining of solvent, solder and flux on the device.

- (1) Solvent cleaning : Solvent temperature 45°C or less, Immersion for 3 min or less
- (2) Ultrasonic cleaning : Please don't carry out ultrasonic cleaning.
- (3) The cleaning shall be carried out with solvent below.

Solvent : Ethyl alcohol, Methyl alcohol

6) Lead pin

Lead terminals of this product are plated with tin copper alloy. Before usage, please evaluate solderability with actual conditions and confirm. And the uniformity in color for the lead terminals are not specified.

2. Outline Dimensions (Drawing No. CY10872i02)

Scale : 5/1

Unit : 1/1mm

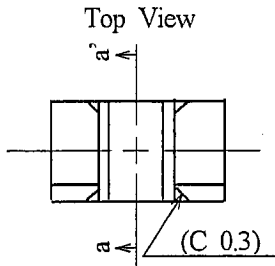

Circuit diagram : Top View

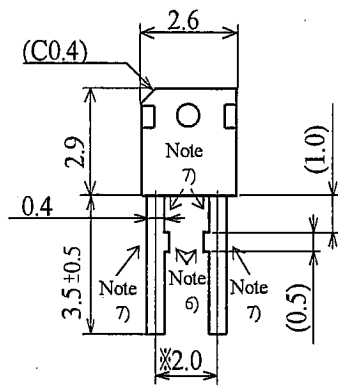
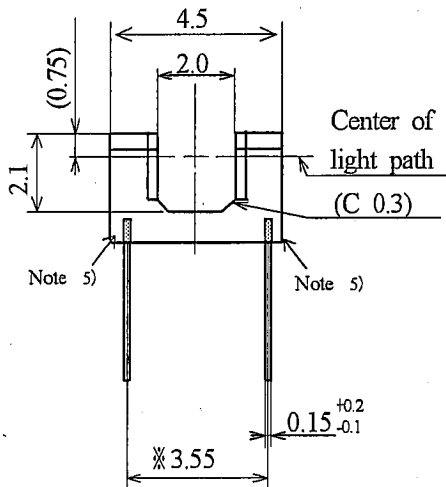
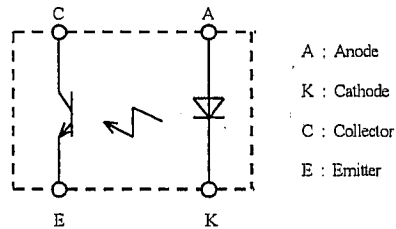

a-a' section

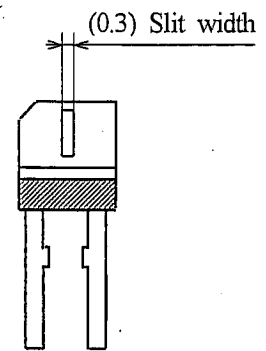

Note

- 1) Unspecified tolerance shall be ± 0.2 .
- 2) Dimensions in parenthesis are shown for reference.
- 3) The dimensions indicated by Ø refer to the those measured from the lead base.
- 4) The dimensions shown do not include those of burrs. Burr's dimensions shall be 0.15 MAX..
- 5) The lead may be exposed at the shaded portion.
- 6) This portion has no solder plating.
- 7) This portion does not have any solder plating in some cases.

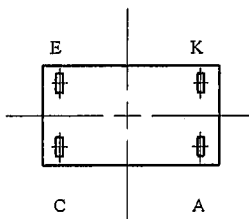

3. Ratings and characteristics

3.1 Absolute maximum ratings

$T_a=25^\circ\text{C}$

| Parameter | | Symbol | Rating | Unit |
|-------------------------|-----------------------------|-----------|-------------|------------------|
| Input | Forward current | I_F | 50 | mA |
| | Reverse voltage | V_R | 6 | V |
| | Power dissipation | P | 75 | mW |
| Output | Collector-emitter voltage | V_{CEO} | 35 | V |
| | Emitter-collector voltage | V_{ECO} | 6 | V |
| | Collector current | I_c | 20 | mA |
| | Collector power dissipation | P_c | 75 | mW |
| Total power dissipation | | P_{tot} | 100 | mW |
| Operating temperature | | T_{opr} | -25 to +85 | $^\circ\text{C}$ |
| Storage temperature | | T_{stg} | -40 to +100 | $^\circ\text{C}$ |
| * Soldering temperature | | T_{sol} | 260 | $^\circ\text{C}$ |

* Soldering time : 5 s or less

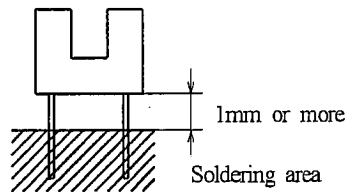

3.2 Electro-optical characteristics

$T_a=25^\circ\text{C}$

| Parameter | | Symbol | Conditions | MIN. | TYP. | MAX. | Unit | |
|--------------------------------------|------------------------|---------------|--------------------------------------|---|------|------|---------------|---------------|
| Input | Forward voltage | V_F | $I_F=20\text{mA}$ | - | 1.2 | 1.4 | V | |
| | Reverse current | I_R | $V_R=3\text{V}$ | - | - | 10 | μA | |
| Output | Collector dark current | I_{CEO} | $V_{CE}=20\text{V}$ | - | - | 100 | nA | |
| Transfer characteristics | Collector current | I_c | $V_{CE}=5\text{V}, I_F=5\text{mA}$ | 100 | - | 400 | μA | |
| | Response time | (Rise) | t_r | $V_{CE}=5\text{V}, I_c=100\mu\text{A}$ $R_L=1\text{k}\Omega$ | - | 50 | 150 | μs |
| | | (Fall) | t_f | | - | 50 | 150 | μs |
| Collector-emitter saturation voltage | | $V_{CE(sat)}$ | $I_F=10\text{mA}, I_c=40\mu\text{A}$ | - | - | 0.4 | V | |

(Test circuit for response time)

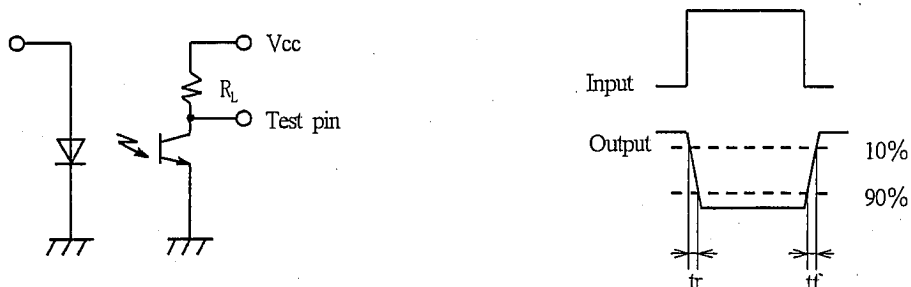

Power dissipation vs. ambient temperature

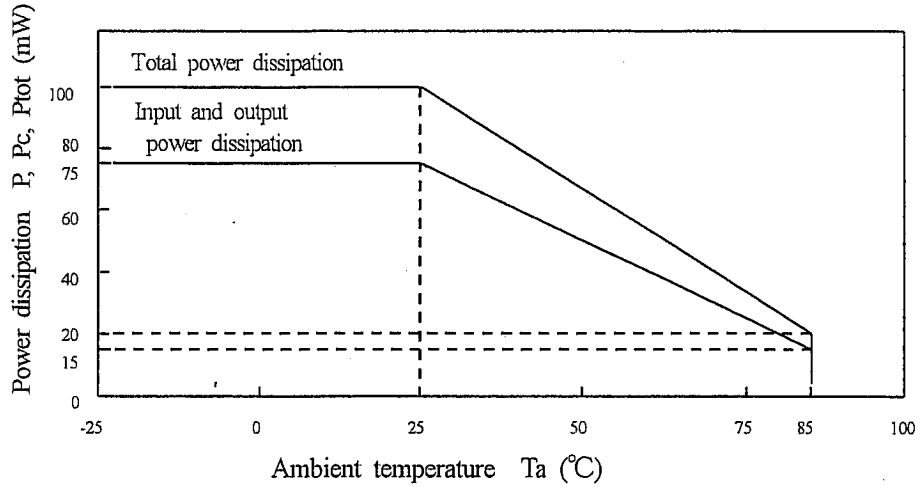

Relative collector current vs. shield distance 1 (Reference value)

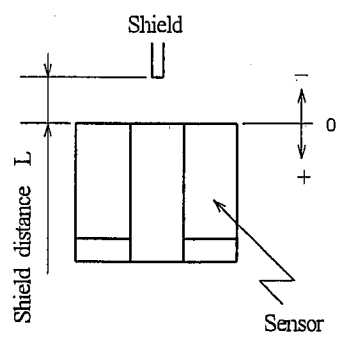
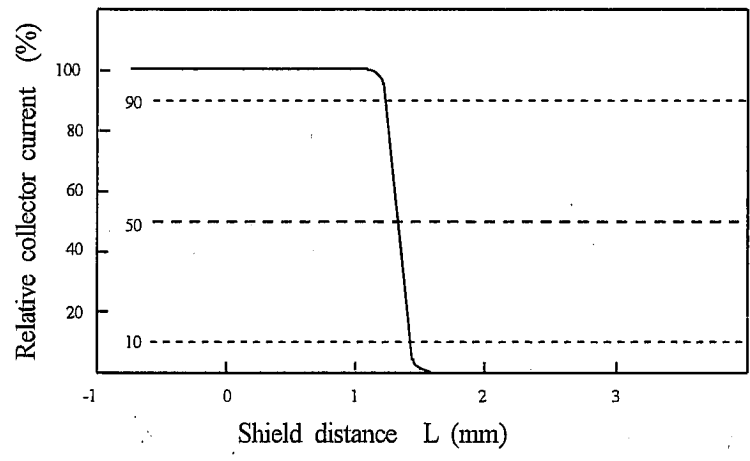

Test condition
 $I_F=5.0\text{mA}$
 $V_{CE}=5\text{V}$
 $T_a=25^\circ\text{C}$

Relative collector current vs. shield distance 2 (Reference value)

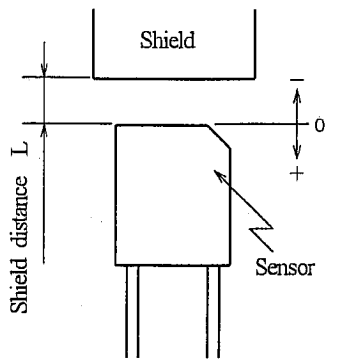
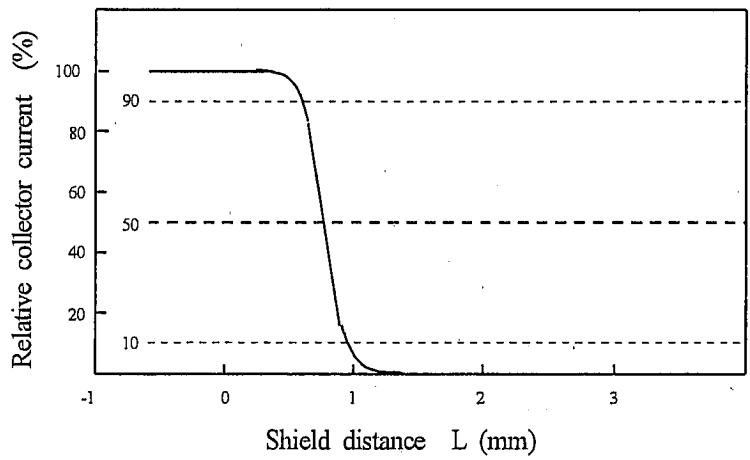

Test condition
 $I_F=5.0\text{mA}$
 $V_{CE}=5\text{V}$
 $T_a=25^\circ\text{C}$

4. Reliability

The reliability of products shall satisfy items listed below.

Confidence level : 90%

LTPD : 10 or 20

| Test Items | Test Conditions | Failure Judgement Criteria | Samples (n) |
|--------------------------------|--|--|---------------|
| | | | Defective (c) |
| Temperature cycling | 1 cycle -40°C to +100°C (30min) (30min) 20 cycles test | $I_R \geq U \times 2$ $I_{CBO} \geq U \times 2$ $V_F \geq U \times 1.2$ $I_c \leq L \times 0.8$ U: Upper specification limit L: Lower specification limit | n=22, c=0 |
| humidity storage | +60°C, 90%RH, 500h | | n=22, c=0 |
| High temp. storage | +100°C, 500h | | n=22, c=0 |
| Low temp. storage | -40°C, 500h | | n=22, c=0 |
| Operation life | $I_F=20mA$, $T_a=25^\circ C$, 500h | | n=22, c=0 |
| Mechanical shock | 15000m/s ² , 0.5ms 3 times/±X, ±Y, ±Z direction | | n=11, c=0 |
| Variable frequency vibration | 100 to 2000 to 100Hz/20min 2h/X, Y, Z direction 100m/s ² | | n=11, c=0 |
| Terminal strength (Tension) | Weight: 3.0N 30s/each terminal | | n=11, c=0 |
| Terminal strength (Bending) *1 | Weight: 1.0N 0° →90° →0° →-90° →0 1time bending | | n=11, c=0 |
| Soldering heat *2 | 260°C, 5s Immerse up to 1mm from the bottom face of package. | | n=11, c=0 |
| Solderability *2, *3 | 245°C, 3s Prior disposition: Dip rogin flux. Then immerse up to 1mm from the bottom face of package. | Judgement only appearance Solder shall adhere at less than 95% area of immersed portion of lead. | n=11, c=0 |

* Terminal bending direction is shown below.

* Soldering area is shown below.

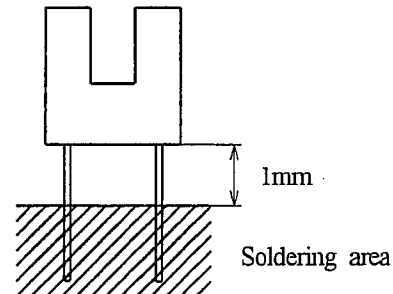
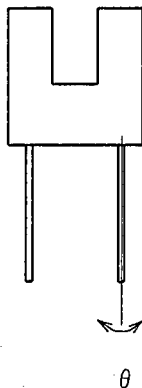

*3 The alloy composition of solder used for lead free should be Sn-2.5Ag-1Bi-0.5Cu or Sn-3.0Ag-0.5Cu.
Flux used for precleaning should be equivalent to EC-19S(TAMURA KAKEN CORPORATION).

5. Outgoing inspection

5.1 Inspection items

(1) Electrical characteristics

$V_F, I_R, BV_{ECO}, BV_{CEO}, I_C, I_{CEO}, V_{CE(sat)}$

(2) Appearance

5.2 Sampling method and Inspection level

A single sampling plan, normal inspection level II based on ISO 2859 is applied.

The AQL according to the inspection items are shown below.

| Defect | Inspection item | AQL (%) |
|--------------|---|---------|
| Major defect | Characteristics defect | 0.065 |
| Minor defect | Defects on appearance except shown above. * | 0.25 |

* Crack ... Visible crack shall be defect.

Split

* Chip ... One which affects the electrical characteristics shall be defect.

Scratch

The others

6. Supplements

6.1 Parts

This product uses the below parts.

6.1.1 Light detector (Quantity : 1)

| Type | Material | Maximum sensitivity (nm) | Sensitivity (nm) | Response time (μ s) |
|-----------------|--------------|--------------------------|------------------|--------------------------|
| Phototransistor | Silicon (Si) | 930 | 700 to 1200 | 20 |

6.1.2 Light emitter (Quantity : 1)

| Type | Material | Maximum light emitting wavelength (nm) | I/O Frequency (MHz) |
|--|----------|--|---------------------|
| Infrared light emitting diode (non-coherent) | GaAs | 950 | 0.3 |

6.1.3 Material

| Case | Lead frame | Lead frame plating |
|----------------------------|------------|--------------------|
| Black PPS resin (UL 94V-0) | 42 Alloy | SnCu plating |

6.1.4 Others

This product shall not be proof against radiation flux.

6.2 Package (Drawing No. : SOE001327)

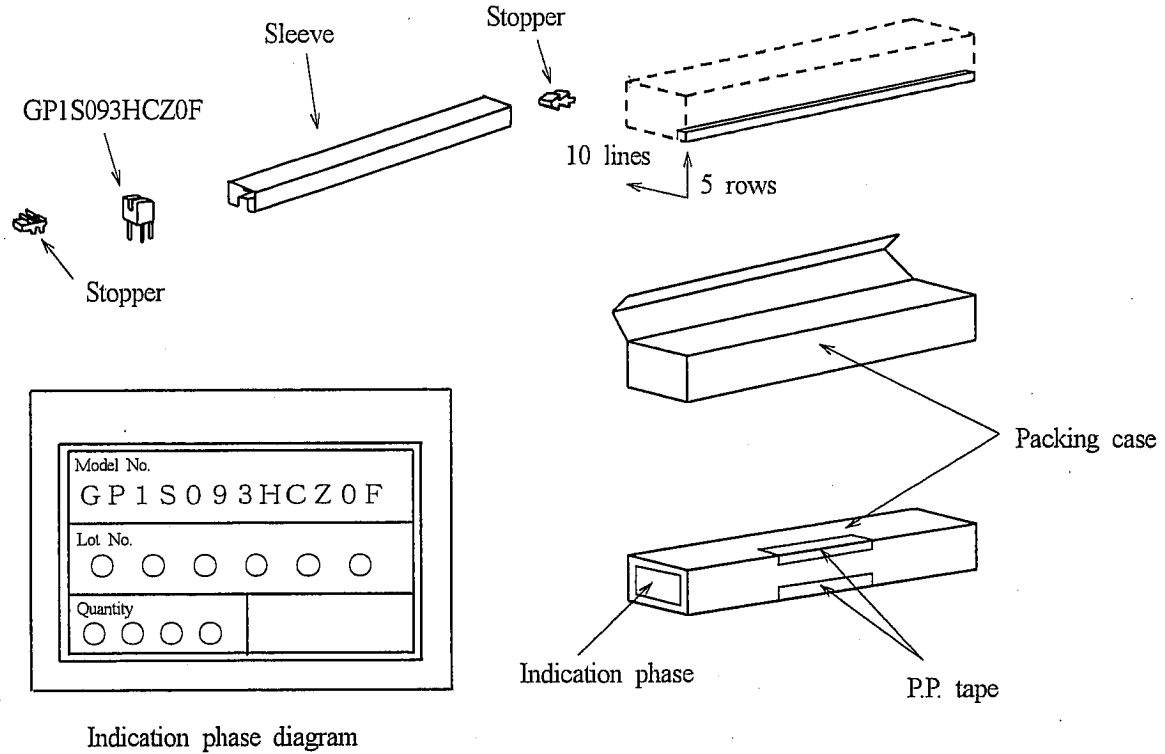

1) Package materials

Outer package : Packing case (Corrugated cardboard)

Inner package : Sleeve (Polystyrene)

Stopper (Styrene-Elastomer)

2) Packaging numbers

MAX. 100 pieces per sleeve

MAX. 5,000 pieces per case

3) Package specifications

Arranges in 5 rows in 10 lines of sleeves containing GP1S093HCZ0F into the outer case.

Closes the lid of outer case and seals with P.P. tapes.

4) Indication items

Indicates on the outer case "Model No.", "Lot No.", "Quantity" and "Inspection date".

5) Regular packing mass

(Excluding fractions, however above packing material, packing count, packing style)

- Approx. 790g